

---

Ornithological Monographs No. 45

---



**Descriptions of Thirty-two  
New Species of Birds from the  
Hawaiian Islands:  
Part I. Non-Passeriformes**

*by*

**Storrs L. Olson and Helen F. James**

---

Ornithological Monographs No. 46

---

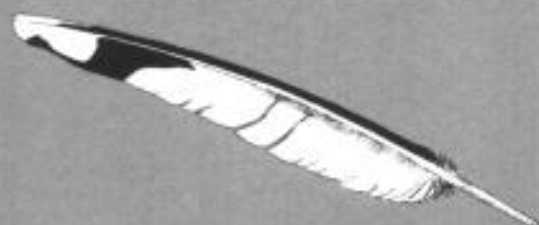

**Descriptions of Thirty-two  
New Species of Birds from the  
Hawaiian Islands:  
Part II. Passeriformes**

*by*

**Helen F. James and Storrs L. Olson**

DESCRIPTIONS OF THIRTY-TWO  
NEW SPECIES OF BIRDS FROM THE  
HAWAIIAN ISLANDS:  
PART II. PASSERIFORMES

ORNITHOLOGICAL MONOGRAPHS

Edited by

NED K. JOHNSON  
Museum of Vertebrate Zoology  
&  
Department of Integrative Biology  
Life Sciences Building  
University of California  
Berkeley, California 94720

*Ornithological Monographs*, published by the American Ornithologists' Union, has been established for major papers too long for inclusion in the Union's journal, *The Auk*. Publication has been made possible through the generosity of the late Mrs. Carll Tucker and the Marcia Brady Tucker Foundation, Inc. Correspondence and manuscripts proposed for publication should be addressed to the Editor at the above address. Style and format should follow those of previous issues.

Copies of *Ornithological Monographs* may be ordered from the Assistant to the Treasurer of the AOU, Max C. Thompson, Department of Biology, Southwestern College, 100 College St., Winfield, KS 67156.

Price of *Ornithological Monographs* 45 and 46 bound together (not available separately): \$25.00 prepaid (\$22.50 to AOU members).

Library of Congress Catalogue Card Number 91-72283

Printed by the Allen Press, Inc., Lawrence, Kansas 66044

Issued June 7, 1991

Copyright © by the American Ornithologists' Union, 1991

ISBN: 0-935868-54-2

DESCRIPTIONS OF THIRTY-TWO NEW SPECIES  
OF BIRDS FROM THE HAWAIIAN ISLANDS:  
PART II. PASSERIFORMES.

BY

HELEN F. JAMES and STORRS L. OLSON

Department of Vertebrate Zoology  
National Museum of Natural History  
Smithsonian Institution  
Washington, DC 20560

ORNITHOLOGICAL MONOGRAPHS NO. 46

PUBLISHED BY  
THE AMERICAN ORNITHOLOGISTS' UNION  
WASHINGTON, D.C.

1991



## TABLE OF CONTENTS

LIST OF FIGURES .....	4
LIST OF TABLES .....	5
INTRODUCTION .....	7
MATERIALS AND METHODS .....	8
SYSTEMATIC PALEONTOLOGY .....	11
ORDER PASSERIFORMES .....	11
Family Corvidae .....	11
Genus <i>Corvus</i> Linnaeus, 1758 .....	11
<i>Corvus impluviatus</i> , new species .....	12
<i>Corvus viriosus</i> , new species .....	19
Family Fringillidae .....	22
Subfamily Carduelinae .....	22
Tribe Drepanidini .....	22
Genus <i>Telespiza</i> Wilson, 1890 .....	27
<i>Telespiza persecutrix</i> , new species .....	30
<i>Telespiza ypsilon</i> , new species .....	35
<i>Telespiza</i> aff. <i>ypsilon</i> , Maui .....	35
Genus <i>Chloridops</i> Wilson, 1888 .....	36
<i>Chloridops</i> sp., Kauai .....	36
<i>Chloridops wahi</i> , new species .....	36
<i>Chloridops</i> sp., Maui .....	40
<i>Chloridops regiskongi</i> , new species .....	40
Genus <i>Incertae Sedis</i> , Unassigned Maui Finch .....	43
Genus <i>Rhodacanthis</i> Rothschild, 1892 .....	44
<i>Rhodacanthis</i> aff. <i>palmeri</i> Rothschild, 1892 .....	44
<i>Rhodacanthis</i> aff. <i>flaviceps</i> Rothschild, 1892 .....	45
<i>Orthiospiza</i> , new genus .....	46
<i>Orthiospiza howarthi</i> , new species .....	47
<i>Xestospiza</i> , new genus .....	52
<i>Xestospiza conica</i> , new species .....	53
<i>Xestospiza fastigialis</i> , new species .....	55
Genus <i>Incertae Sedis</i> , Additional Oahu Finch .....	59
Genus <i>Hemignathus</i> Lichtenstein, 1839 .....	59
<i>Hemignathus upupirostris</i> , new species .....	60
<i>Vangulifer</i> , new genus .....	62
<i>Vangulifer mirandus</i> , new species .....	63
<i>Vangulifer neophasis</i> , new species .....	65
<i>Aidemia</i> , new genus .....	66
<i>Aidemia chascax</i> , new species .....	67
<i>Aidemia zanclops</i> , new species .....	69
<i>Aidemia lutetiae</i> , new species .....	71

Genus <i>Ciridops</i> Newton, 1892 .....	73
<i>Ciridops tenax</i> , new species .....	74
<i>Ciridops</i> sp., Oahu .....	77
DISCUSSION .....	78
ACKNOWLEDGMENTS .....	83
SUMMARY .....	85
LITERATURE CITED .....	86

## LIST OF FIGURES

Figure 1. Diagram showing measurements of the maxilla .....	9
2. Diagram showing measurements of the mandible .....	10
3. Skulls and mandibles of Hawaiian <i>Corvus</i> in lateral view .....	13
4. Skulls of Hawaiian <i>Corvus</i> in dorsal view .....	14
5. Skulls of Hawaiian <i>Corvus</i> in ventral view .....	15
6. Mandibles of Hawaiian <i>Corvus</i> in dorsal view .....	17
7. Humeri of Hawaiian <i>Corvus</i> .....	20
8. Hindlimb elements of Hawaiian <i>Corvus</i> .....	21
9. The ventral maxillae in finch-billed drepanidines and <i>Loxops virens</i> .....	26
10. Box plots of measurements of the maxilla in <i>Telespiza</i> .....	31
11. Maxillae of <i>Telespiza</i> .....	32
12. Mandibles of <i>Telespiza</i> in lateral view .....	33
13. Mandibles of <i>Telespiza</i> in dorsal view .....	34
14. Maxillae of <i>Chloridops</i> .....	37
15. Mandibles of <i>Chloridops</i> in dorsal view .....	38
16. Maxillae and mandibles of <i>Chloridops wahi</i> and <i>C. kona</i> in lateral view .....	42
17. Maxillae and mandible of <i>Chloridops regiskongi</i> in lateral view .....	43
18. Cranium, palatine, and quadrate of <i>Orthospiza howarathi</i> .....	47
19. Maxillae of <i>Orthospiza howarathi</i> and <i>Rhodacanthis flaviceps</i> .....	48
20. Mandibles of <i>Orthospiza howarathi</i> and <i>Rhodacanthis flaviceps</i> .....	50
21. Postcranial elements of <i>Orthospiza howarathi</i> .....	51
22. Maxillae of <i>Melamprosops</i> and <i>Xestospiza</i> .....	54
23. Mandibles of <i>Melamprosops</i> and <i>Xestospiza</i> .....	56
24. Bones of the holotype of <i>Xestospiza fastigialis</i> .....	58
25. Mandibles of <i>Hemignathus</i> .....	61
26. Maxillae of <i>Vangulifer</i> .....	64
27. Mandibles of <i>Vangulifer</i> .....	65
28. Maxillae of <i>Aidemia</i> and <i>Loxops sagittirostris</i> .....	68
29. Mandibles of <i>Aidemia</i> and <i>Loxops sagittirostris</i> in lateral view .....	70
30. Mandibles of <i>Aidemia</i> and <i>Loxops sagittirostris</i> in dorsal view .....	72
31. Maxillae of <i>Ciridops</i> in lateral view .....	74

32.	Maxillae of <i>Ciridops</i> in dorsal and ventral views .....	75
33.	Mandibles of <i>Ciridops</i> in dorsal view .....	77
34.	Mandibles of <i>Ciridops</i> in lateral view .....	78
35.	Pelvic and hindlimb elements of <i>Ciridops</i> .....	79

## LIST OF TABLES

Table 1.	Measurements of major skeletal elements of Hawaiian <i>Corvus</i> .	18
2.	Measurements of the maxilla in <i>Telespiza</i> and <i>Loxioides</i> .....	28
3.	Measurements of the mandible in <i>Telespiza</i> and <i>Loxioides</i> .....	29
4.	Distribution of species of <i>Telespiza</i> .....	30
5.	Measurements of the maxilla in <i>Chloridops</i> .....	39
6.	Measurements of the mandible in <i>Chloridops</i> .....	39
7.	Measurements of the maxilla in <i>Rhodacanthis</i> and <i>Orthiospiza</i>	45
8.	Measurements of the mandible in <i>Rhodacanthis</i> and <i>Orthiospiza</i>	45
9.	Measurements of the maxilla in <i>Xestospiza</i> , <i>Melamprosops</i> and <i>Psittirostra</i> .....	53
10.	Measurements of the mandible in <i>Xestospiza</i> , <i>Melamprosops</i> and <i>Psittirostra</i> .....	57
11.	Measurements of the maxilla and mandible in <i>Aidemia</i> and <i>Loxops sagittirostris</i> .....	69
12.	Measurements of the maxilla and mandible in <i>Ciridops</i> .....	75
13.	Measurements of the postcranial skeleton in <i>Ciridops</i> .....	76
14.	Fossil and historical distribution of endemic passerine birds in the Hawaiian Archipelago .....	80





## INTRODUCTION

The present work continues the description of new species of birds from the Hawaiian Islands that have come to light through fossil collecting over the past two decades (Olson and James 1982a, b; 1984). In the preceding part (Olson and James, 1991), we briefly describe the various fossil localities and introduce 3 new genera and 16 new species of non-passerines, including 1 petrel, 5 raptorial species, and 10 species that were flightless or nearly so. Here we treat the Passeriformes, describing as new 2 species of crows (Corvidae) and 4 genera and 14 species of Hawaiian finches (Drepanidini). We also discuss but do not name an additional 8 possible new species that are as yet known from insufficient material for proper diagnosis. Although we have found new fossil species of Meliphagidae as well, we have postponed describing them pending further revisionary work. Also not treated at this time are fossils of the families Myiagridae and Muscicapidae, which do not appear to contain any new taxa although they have not been thoroughly studied.

The new passerine taxa are derived from rich fossil deposits found on the islands of Kauai, Oahu, Molokai, and Maui. The less numerous passerine fossils found mainly in archaeological contexts on the island of Hawaii do not include any new taxa, and no passerine fossils have yet been found on the other main islands (Niihau, Lanai, Kahoolawe).

Small passerine bones usually have a different taphonomic history from those of crows and the larger non-passerines that often occur in the same deposits. Passerines from aeolian dunes on Kauai and Molokai were deposited as pellets cast by extinct owls of the genus *Grallistrix*, which evidently roosted either in dune shrubs or directly on the ground in hollows in the dunes. The only non-passerine that is abundant in such owl pellet deposits is the tiny flightless rail *Porzana menehune* of Molokai. Bones of crows and larger non-passerines in the same deposits are thought to be remains of individuals that died among the dunes and were buried by shifting sands, or were deposited either in burrows of nesting seabirds or as human midden material.

Near Barbers Point on Oahu, fossils were found in sediments that had accumulated in sinkholes in a raised limestone reef. In many of the smaller sinkholes, passerines are rare and may have resulted from the chance death of an individual in or over the sink. In other sites, passerine bones are more abundant and may have originated in pellets from nearby roosts of *Grallistrix*. Even in these presumed owl pellet deposits, passerine remains are less concentrated than is usual in primary owl roost accumulations such as those in the dunes mentioned previously, or in barn owl (*Tyto* spp.) roosts in West Indian caves (Pregill 1981). It may be that the owl pellet material at Barbers Point was transported a short distance and redeposited by water, resulting in less concentrated deposits.

On Maui, fossils were found in lava tubes, many of which are concentrated along the southwest rift zone of Mt. Haleakala. The most important of these sites is Puu Naio Cave (James et al. 1987), where finely stratified Holocene sediments were partially excavated in 1984 and 1988. Passerine remains here are believed to have been concentrated in the pitfall opening of the cave by individuals of *Grallistrix* roosting on ledges. During floods, some of the prey remains were transported into the cave where they were preserved.

Passerines must occasionally penetrate caves beyond the light zone, probably at dusk, become disoriented, and never find their way back out, which leads to their associated skeletons being left in a circumscribed area on the floor of the cave. Outstanding examples of this mode of deposition are the flooded cavern at Barbers Point (Site 50-Oa-B6-139), where exquisitely preserved associated skeletons of crows and a species of meliphagid were recovered with SCUBA gear, and Crystal Cave on Maui, where the situation of the cave mouth in the wall of a steep gulch makes it accessible only to bats and volant birds, several species of which were found inside.

The following descriptions do not include a heading for the geological age of the fossils, which is Holocene for all of the new drepanidines, and Late Quaternary for the new crows. A less precise age is given for the crows because both new species occur in the flooded cavern at Barbers Point, mentioned above. Fossils from this site, thought to be older than those from sediment-filled sinkholes in the vicinity, possibly date to the Late Pleistocene.

The limited amount of radiocarbon data that is available from the dune sites on Kauai and Molokai, and from the sediment-filled sinkholes on Oahu, indicates that all of the passerine fossils from these sites are probably less than 7,000 years old, and most are less than 5,000 years old (Olson and James 1982b; Olson and James 1991). The bones that have been dated from lava tube sites on Maui are all less than 5,500 years old (Thomas W. Stafford, Jr., pers. comm.), except that those from Puu Nairo Cave span the Holocene from at least 8,000 years ago to the present (James et al. 1987), and those from the Crystal Cave site, which have not been dated, may be even older.

The only passerine fossils that are certainly known to antedate the Holocene are those from Ulupau Head, Oahu, where the bone-bearing lacustrine and colluvial sediments are more than 120,000 years old (James 1987). This site is still being actively collected and the material has not been fully studied.

## MATERIALS AND METHODS

Format and organization are as in Part I (Olson and James 1991). Within genera, or groups of related species within a genus, the order of presentation in text and tables is geographic, from west to east. For economy of space, not all paratypes are listed (see Olson and James 1991). Although statements of distribution include species identified from the Pleistocene deposits at Ulupau Head, none of the specimens from that locality were used in the diagnoses of new taxa or are considered paratypes.

One of the greatest obstacles to carrying out this study was the lack of adequate comparative osteological specimens of the endemic species that make up the historically known passerine fauna. Many of these species became extinct or endangered before any skeletal specimens of them were ever prepared. We were able to compensate for this by removing the skull and mandible, and sometimes limb elements, from study skins by the method described by Olson et al. (1987), so that at least one skull and mandible were available for all but two of the species of drepanidines.

Measurements were taken with digital calipers to the nearest 0.1 mm. Because of the highly diagnostic morphology of the maxilla and mandible, 23 different measurements were taken of these elements, as shown in Figs. 1 and 2. These

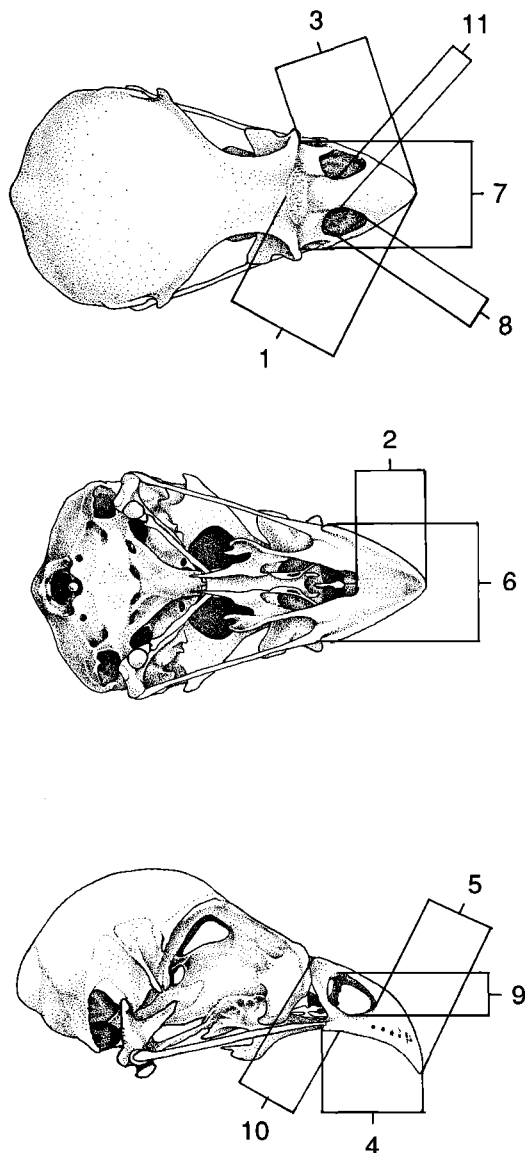

FIG. 1. Diagram showing measurements of the maxilla (*Loxioides bailleui* in dorsal, ventral, and lateral views [top to bottom]): 1, dorsal length; 2, ventral length; 3, length from lateral corner of nasofrontal hinge; 4, length from jugal articulation; 5, length from anterior narial opening; 6, maximum width; 7, width of nasofrontal hinge; 8, length of narial opening; 9, height of narial opening; 10, height through lateral nasal bar; 11, minimum width of dorsal nasal bar.

were supplemented with measurements of the cranium and postcranial skeleton when such elements were preserved and could be positively identified. Mensural data are organized to serve the dual purpose of characterizing the hypodigm of each new species and of identifying the holotype itself by its unique dimensions. Tables give means, standard deviations, and ranges for sample sizes of 5 or greater, with the measurement of the holotype listed separately in the text, but list indi-

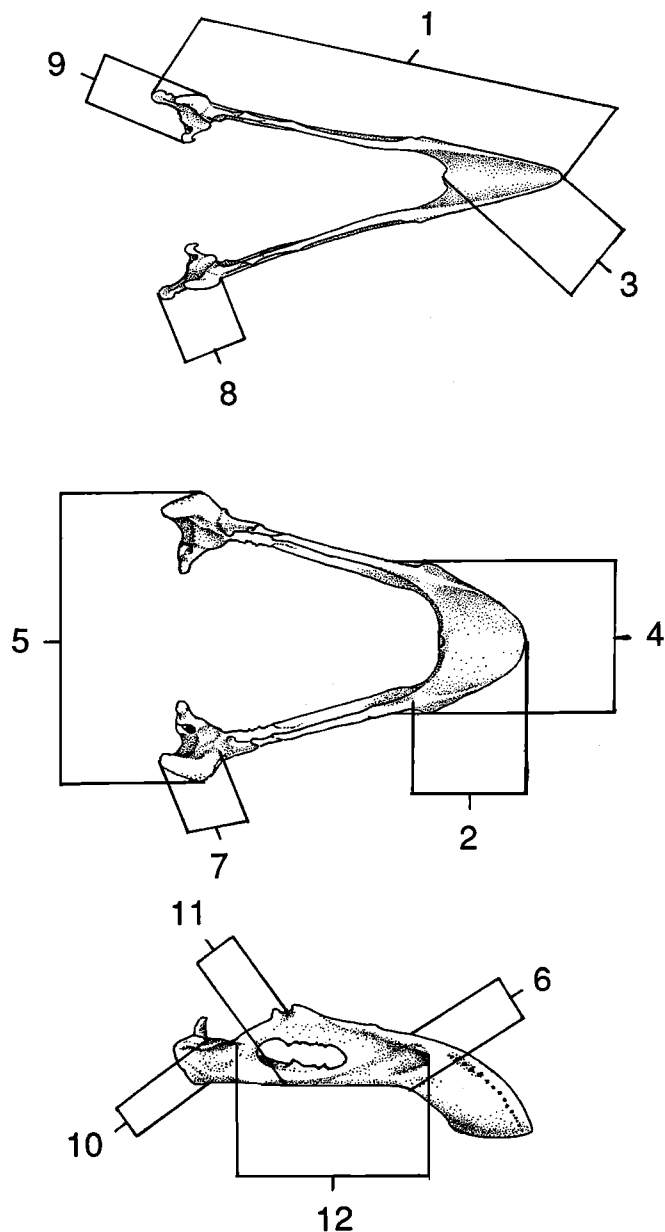

FIG. 2. Diagram showing measurements of the mandible (*Vestiaria coccinea*, dorsal view, above; *Loxioides bailleui*, dorsal and lateral views, middle and below): 1, total length; 2, length of tomial crest; 3, symphysis length; 4, greatest width of symphysis; 5, greatest width of mandible; 6, symphysis height; 7, length of lateral cotyla; 8, length of lateral cotyla plus retroarticular process; 9, width of articular end with medial process; 10, height at lateral cotyla; 11, height at angle of mandible; 12, ramus length (middle part).

vidual data for samples of 4 or fewer. In the latter case, the measurement of the holotype is identified in the table with an H.

SYSTAT (Wilkinson 1989) and SYGRAPH (Wilkinson 1988) software were used for statistical tests and box plots.

Terminology is drawn from Baumel et al. (1979), Richards and Bock (1973), Howard (1929), and Zusi (1978; the term cranial fenestra only). We employ the terms of position and direction used by Howard (1929), instead of those recommended by Baumel et al. (1979). Thus, in place of cranial, rostral, and anterior, we use anterior, and in place of caudal we use posterior.

As used here, maxilla and mandible refer to the bony elements of the jaws, whereas maxillary rostrum and mandibular rostrum refer to the external rhamphothecal covering together with the underlying bony parts of these elements. Narial opening refers specifically to the external margin of the bony naris. The mandibular ramus between the articular end and the symphysis is referred to as the middle part of the ramus, anglicized from Baumel et al. (1979) (see Fig. 2).

All of the Hawaiian fossil material treated in this study is housed either in the Department of Zoology, Bernice P. Bishop Museum, Honolulu, or the Department of Paleobiology, National Museum of Natural History, Smithsonian Institution, Washington, D.C. Comparative material was examined from the following collections:

AMNH—American Museum of Natural History, New York.

ANSP—Academy of Natural Sciences, Philadelphia.

BMNH—British Museum (Natural History), Tring.

BBM, BBM-X, BPBM—Bernice P. Bishop Museum, Honolulu.

AU—Geology Department, Auckland University, Auckland.

CMC—Canterbury Museum, Christchurch.

MCZ—Museum of Comparative Zoology, Harvard University, Cambridge, Massachusetts.

MVZ—Museum of Vertebrate Zoology, University of California, Berkeley.

NMNZ—National Museum of New Zealand, Wellington.

PB—Pierce Brodkorb Collection, University of Florida, Gainesville.

USNM—National Museum of Natural History, Smithsonian Institution, Washington, D.C.

ZMB—Museum für Naturkunde, Humboldt-Universität, Berlin.

## SYSTEMATIC PALEONTOLOGY

### Order PASSERIFORMES

#### Family CORVIDAE

#### Genus *Corvus* Linnaeus, 1758

Two new species of crows in lowland fossil sites on Oahu and Molokai (Olson and James 1982a, b, 1984) are known from associated fossil skeletons preserved so well as to rival the best skeletal preparations in modern museum collections. These fossils were collected under water in a flooded cavern near Barbers Point, Oahu. We have designated specimens from this cavern as the holotypes for both of the new species, although one of the species is known so far from Oahu only from the holotype, and occurs far more abundantly in the dune sites on Molokai.

Bones of crows have also been found in lava tubes on Maui (James et al. 1987)

and Hawaii. These are all isolated elements or fragmentary skeletons that need further study before they can be identified to species with reasonable assurance.

We compared the new Hawaiian crows to all other species of *Corvus* that occur in the Pacific Basin and peripheral continental areas, except two geographically restricted species for which specimens were not available.

To simplify our diagnoses, we can eliminate the following species from further discussion. The new Hawaiian crows are markedly larger than *Corvus dauuricus*, *C. moneduloides*, *C. enca*, *C. typicus*, *C. kubaryi* (bill also narrower), *C. frugilegus*, *C. brachyrhynchos*, *C. caurinus*, *C. imparatus*, *C. orru*, *C. torquatus* (bill also less deep), or *C. cryptoleucus*. The bills of the new species are deeper than in *C. coronoides*, *C. mellori*, *C. torquatus*, or *C. validus*. Compared to the new species, *Corvus corone* has the ventral surface of the maxilla less excavated, the nostril longer, and the bill less deep; *C. bennetti* has a smaller bill; and *C. tristis* has the mandible less deep and the sternum relatively large in proportion to humerus length.

*Comparative material examined:* The complete skeleton of *Corvus hawaiiensis* that we used in our comparisons, USNM 501638, is from an atypically small male bird. We supplemented this specimen by removing the skull, mandible, and several long bones from the skin of a large male of *C. hawaiiensis*, USNM 177993. Specimens of *C. florensis* (restricted to Flores in the Lesser Sundas) and *C. fuscicapillus* (restricted to parts of New Guinea and its satellites) were not available for comparison. Skeletal material from the Smithsonian collections included: *C. dauuricus* male, 292083; females, 292082, 319401. *C. moneduloides* male, 561635; female, 561634. *C. enca* male, 225830; unsexed, 224802. *C. typicus* male, 226205 (trunk only). *C. kubaryi* unsexed, 613280. *C. validus* males, 557299, 557300, 558297; females, 489028, 557301. *C. tristis* female, 489028. *C. frugilegus* males, 290314, 291673. *C. brachyrhynchos* male, 554206; female, 499510. *C. caurinus* males, 561899, 612996; females, 612993, 612995. *C. corone* male, 500773; unsexed, 289948. *C. macrorhynchos* males, 290456, 292081, 500768; females, 290955, 500774; unsexed, 318366. *C. orru* male, 559044, females, 558338, 559045. *C. torquatus* males, 289947, 291412, 292078; female, 292858. *C. cryptoleucus* males, 553971, 553972, 553973, 555254; females, 498679, 554139. *C. corax* males, 489704, 499938; female, 555261; unsexed, 18622, 290441. Of *C. moriorum*, we examined the following subfossil specimens: NMNZ S 962, skull and partial skeleton; AU 6120, partial postcranial skeleton; AU 6121.16, mandible; CMC AV3310, skull and partial skeleton. We also made comparisons with study skins of the following species in the Smithsonian collections: *C. hawaiiensis* (12 specimens), *C. woodfordi*, *C. meeki*, *C. imparatus*, *C. bennetti*, *C. coronoides*, and *C. mellori*.

***Corvus impluviatus*, new species**  
(Figs. 3B, 4B, 5B, 6B, 7B, 8B, E)

“*Corvus*, deep-billed” Olson and James, 1982b:38, 44; 1984:771.

*Holotype:* Nearly complete skeleton, BBM-X 153652. Collected 22 July 1977 by Storrs L. Olson, Helen F. James, Aki Sinoto and others, with the aid of SCUBA gear. The specimen includes the cranium with the maxilla, palatines, and jugals in place (Figs. 3B, 4B, 5B), both pterygoids, both quadrates, the left prefrontal,

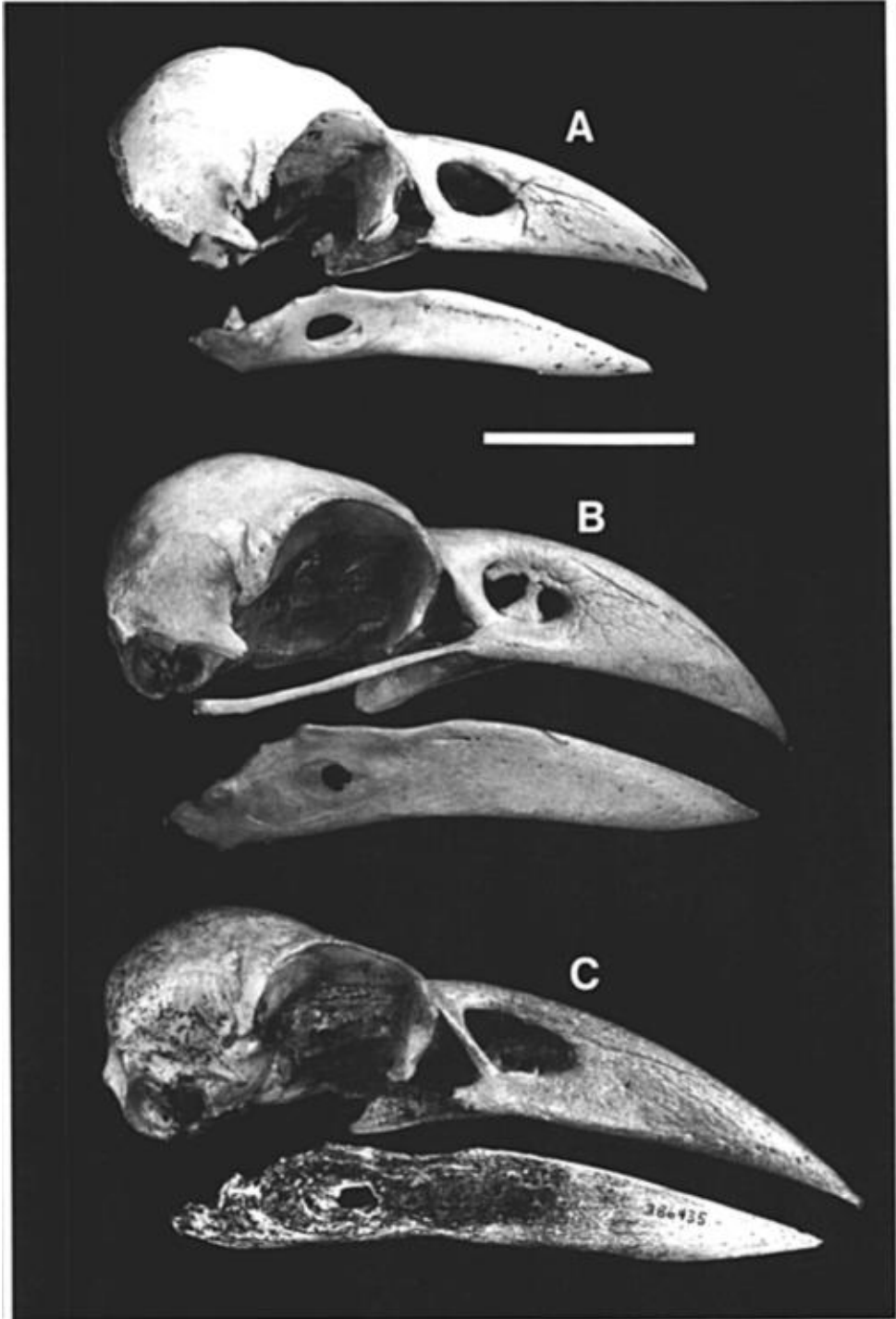

FIG. 3. Skulls and mandibles of Hawaiian *Corvus* in lateral view. A, *C. hawaiiensis* (skull, USNM 177993; mandible, USNM 501638); B, *C. impluviatus*, new species, holotype (BBM-X 153652); C, *C. viriosus*, new species, holotype (USNM 386435; image of cranium is of the left side printed in reverse). Scale = 3 cm.



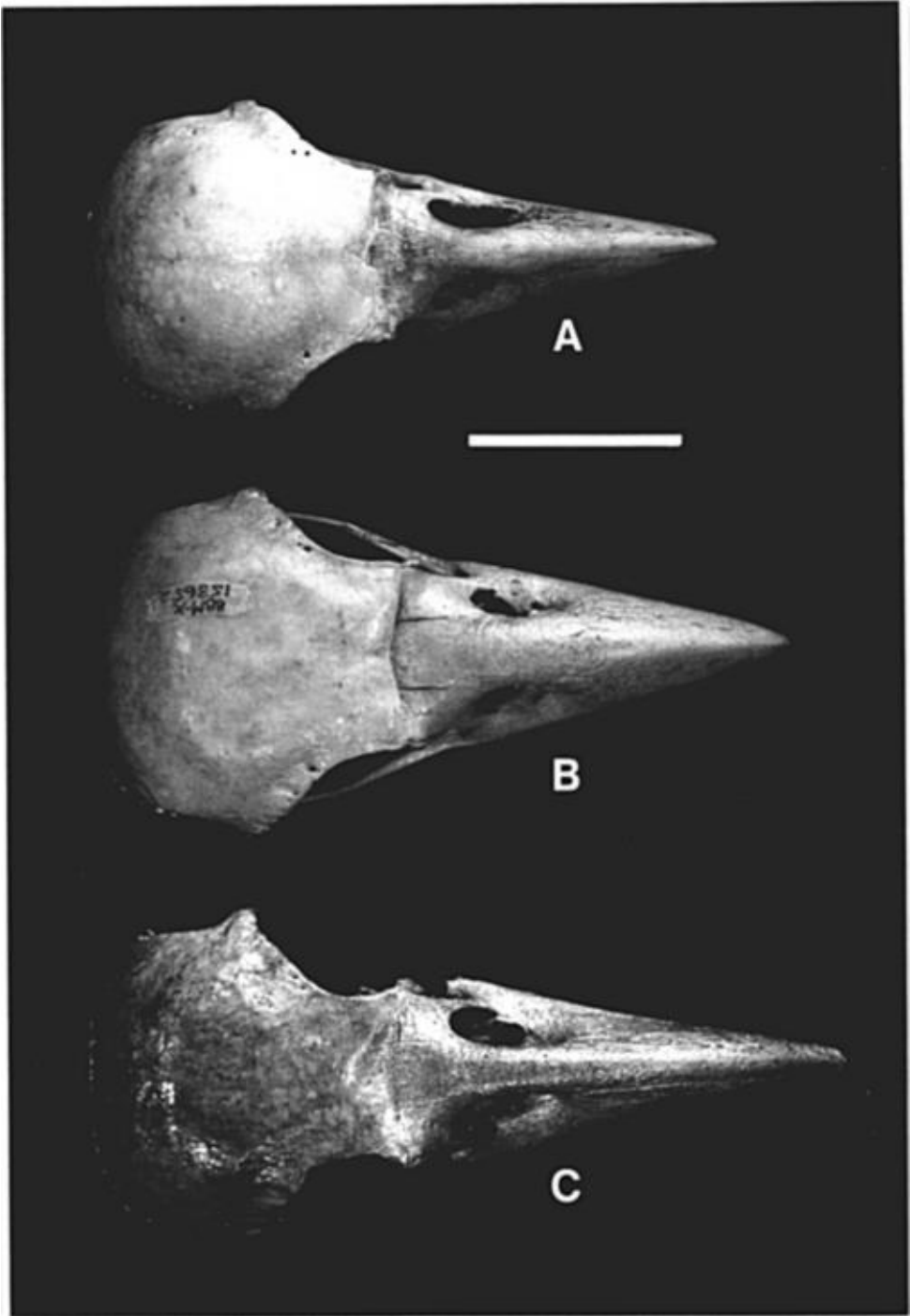

FIG. 4. Skulls of Hawaiian *Corvus* in dorsal view. A, *C. hawaiiensis* (USNM 177993); B, *C. impluviatus*, new species, holotype (BBM-X 153652); C, *C. viriosus*, new species, holotype (USNM 386435). Scale = 3 cm.

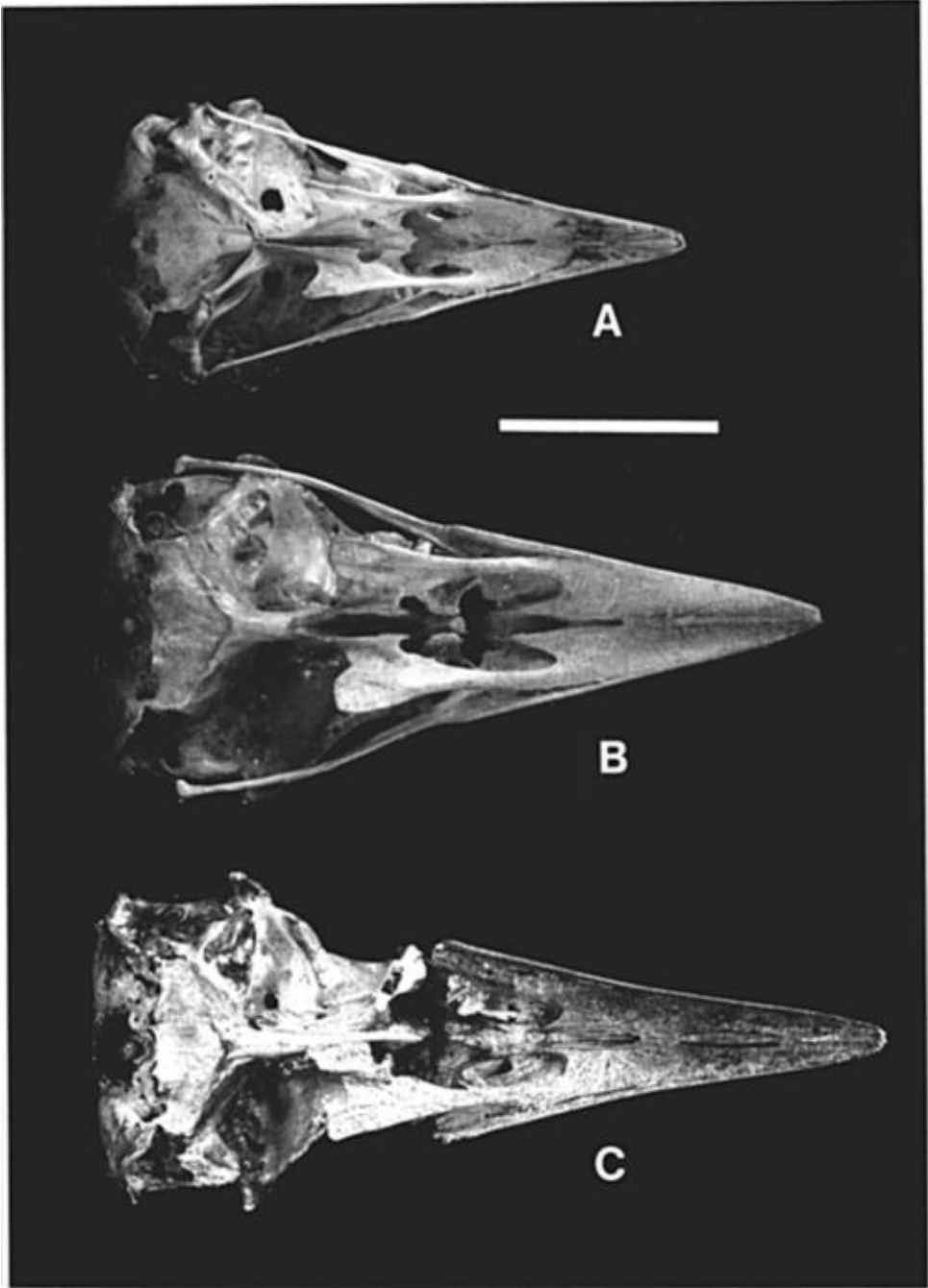

FIG. 5. Skulls of Hawaiian *Corvus* in ventral view. A, *C. hawaiiensis* (USNM 501638); B, *C. impluviatus*, new species, holotype (BBM-X 153652); C, *C. viriosus*, new species, holotype (USNM 386435). Scale = 3 cm.

the mandible (Figs. 3B, 6B), twelve tracheal rings, the syringeal drum, the furcula, the sternum, ten complete ribs plus some fragments, ten cervical vertebrae (the complete cervical series except for the fourth vertebra), three caudal vertebrae, all of the long bones of the pectoral skeleton (scapulae, coracoids, humeri (Fig. 7B), ulnae, radii, carpometacarpi), the radiale, ulnare, and one alar phalanx from the right side, the left femur (Fig. 8B), both tibiotarsi and fibulae, the right tarsometatarsus (Fig. 8E), and twelve pedal phalanges.

*Type locality:* Flooded cavern, Site 50-Oa-B6-139, Barbers Point, Oahu, Hawaiian Islands.

*Distribution:* Oahu: Barbers Point.

*Etymology:* An adjective formed from Latin, *impluvium*, n., the skylight in the roof of the atrium of a Roman house, in reference to the nature of the type locality, which we entered by leaping through a skylight into the clear water below. The root word *pluvius*, meaning rainy, may be taken as a further allusion to the watery environment of the cavern.

*Measurements (mm) of holotype:* Maxilla: dorsal length, 66.8; length from anterior rim of narial opening, 40.2; maximum width, 26.7; width of nasofrontal hinge, 23.8; maximum height, 21.4; height through lateral nasal bar, 24.1; length of narial opening, 13.7; height of narial opening, 8.5. Cranium: total length with maxilla, 105.1; length from supraoccipital to nasofrontal hinge, 45.4; length from nasofrontal hinge to bill tip, 66.7; orbit length (ectethmoid to postorbital process), 26.2; width of frontal between orbit rims, 25.6; width behind postorbital processes, 42.9; height from basitemporal plate to skull roof, 31.7; length of basitemporal plate (anterior margin of basitemporal plate to posterior extremity of occipital condyle), 15.7; width between external rims of the articular faces for the quadrates, 39.9. Mandible: total length, 87.3; length of tomial crest, 52.8; symphysis length, 22.2; greatest width of mandible, 45.0; width of articular end with medial process, 16.9; height at angle of mandible, 15.5; greatest height of sub-rhamphothecal ramus, 13.8. Scapula: length, 57.2; proximal width, 14.2. Sternum: length through manubrial spine, 62.1; width below costal facets, 32.2; length of carina, 60.5; depth of carina, 18.6. Coracoid: length, 51.2; width of sternal end, 13.2. Humerus: length, 78.5; proximal width, 21.2; length of deltoid crest, 24.3; mid-shaft width, 6.9; distal width, 17.1. Ulna: proximal width, 11.8; distal width, 11.2. Radius: length, 85.9. Carpometacarpus: length, 55.6; proximal depth, 12.9; distal depth, 12.0. Pelvis: width across trochanters, 40.5. Femur: length, 63.1; proximal width, 13.7; mid-shaft depth, 4.6; distal width, 13.2. Tibiotarsus: length without cnemial crest, 105.4; proximal width, 32.9; length of fibular crest, 17.8; distal width, 11.4. Tarsometatarsus: length, 72.2; proximal width, 12.7; mid-shaft width, 4.6; depth of third trochlea, 5.2. For additional measurements, see Table 1.

*Paratypes:* Partial skeleton, USNM 386431, including the cranium (with maxilla, palatines, and jugals attached), the right pterygoid, the left quadrate, the mandible, the furcula, sternum and pelvis, fifteen complete ribs plus some rib fragments, the atlas and axis and seven additional cervical vertebrae, four thoracic vertebrae, the right scapula, the left coracoid, the humeri, radii, carpometacarpi, and the first phalanges from the right and left major digit, all of the long bones of the hindlimb (femora, tibiotarsi, fibulae, tarsometatarsi), and the first phalanx of the hallux.

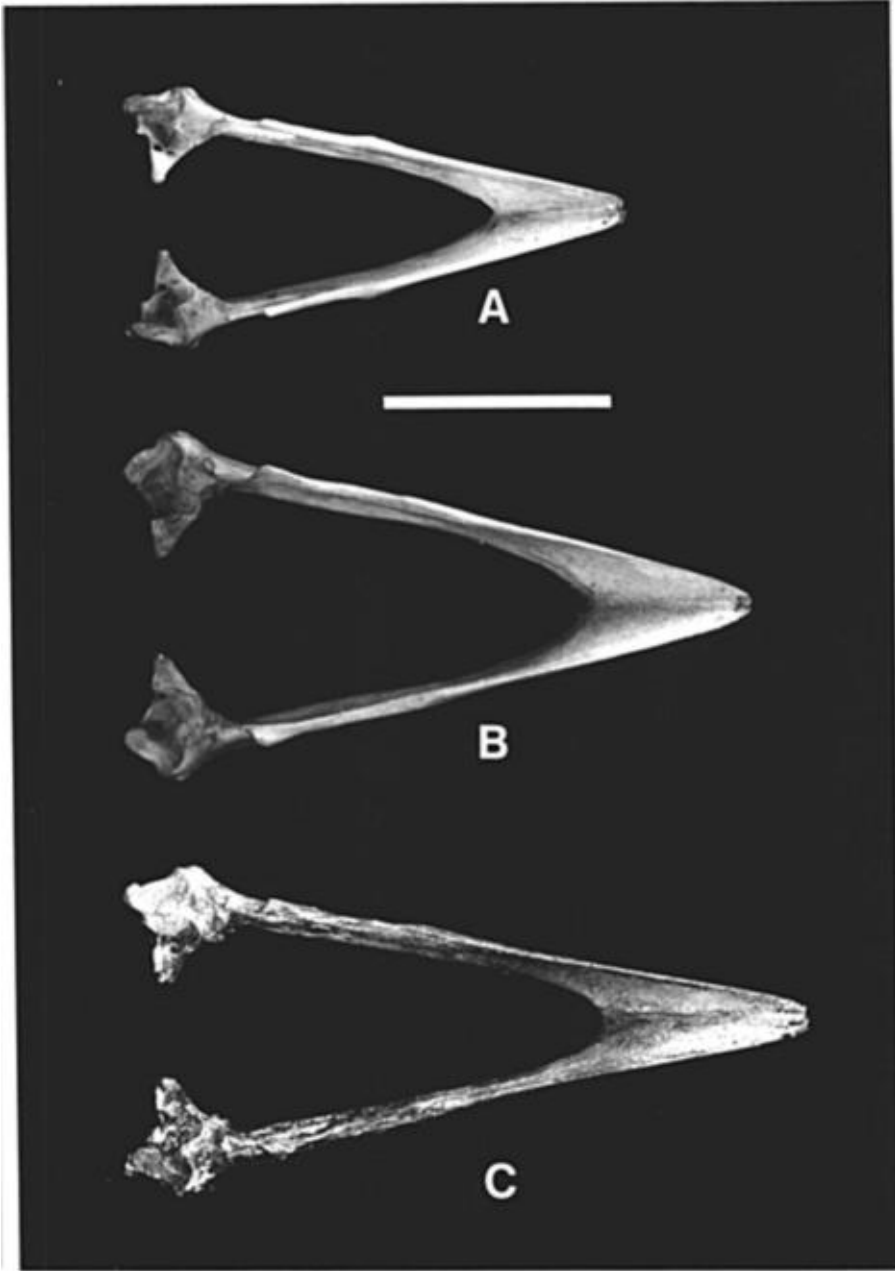

FIG. 6. Mandibles of Hawaiian *Corvus* in dorsal view. A, *C. hawaiiensis* (USNM 501638); B, *C. impluviatus* new species, holotype (BBM-X 153652); C, *C. viriosus* new species, holotype (USNM 386435). Scale = 3 cm.

Partial skeleton, USNM 386428, including the skull and mandible, right coracoid, eroded sternum and pelvis, some ribs and vertebrae, and the paired scapulae, humeri, ulnae, radii, femora, tibiotarsi, and tarsometatarsi.

Partial skeleton, USNM 386427, including the mandible, furcula, sternum,

TABLE 1

LENGTH MEASUREMENTS (MM) OF THE MAJOR SKELETAL ELEMENTS IN HAWAIIAN *Corvus*. MEAN, STANDARD DEVIATION, AND RANGE ARE GIVEN FOR SAMPLE SIZES GREATER THAN 4; DATA ARE LISTED INDIVIDUALLY FOR SAMPLE SIZES OF 4 OR FEWER. H = HOLOTYPE

	<i>Corvus imfluviatus</i>	<i>Corvus viriosus</i>	<i>Corvus hawaiiensis</i>
Skull	102.3 ± 4.6 95.1-107.4 n = 6	105.9, 112.6 H	84.3, 94.0
Quadrate	16.1, 16.1, 16.2 H	15.0, 15.0, 15.5	11.4, 13.3
Maxilla	64.7 ± 3.4 59.6-68.5 n = 6	65.1, 74.2 H	47.2, 57.2
Mandible	86.5 ± 3.1 80.7-89.4 n = 8	83.0, 89.8, 94.5 H	67.8, 77.1
Sternum	62.1 ± 2.5 59.3-66.1 n = 5	57.8 H	—
Synsacrum	52.2 H, 55.8, 57.9, 58.3	49.8, 51.0 H	45.9
Scapula	56.9, 57.2 H, 60.2	57.0	47.5
Coracoid	50.8 ± 1.8 47.9-52.4 n = 5	45.1, 45.2, 46.2, 49.2 H	40.5
Humerus	79.1 ± 1.8 76.3-80.7 n = 5	73.4 ± 2.9 70.8-77.7 n = 8	62.9
Ulna	90.8, 94.2 H, 94.9, 96.7	85.3 ± 3.6 77.4-88.9 n = 11	72.5, 80.6
Radius	85.9 ± 2.3 82.2-87.8 n = 5	78.5 H, 80.3, 80.3, 81.0	66.6
Carpometacarpus	55.4 ± 1.4 53.3-57.2 n = 5	50.8, 50.9 H, 52.8	43.5
Femur	62.8 ± 2.3 59.6-66.1 n = 5	60.4 ± 2.2 58.2-63.4 n = 8	52.3
Tibiotarsus without cnemial crest	104.1 ± 3.6 98.5-108.3 n = 5	98.7, 99.2, 102.2 H, 106.2	88.4, 97.9
Tarsometatarsus	71.4 ± 2.9 67.4-75.1 n = 5	69.1 ± 3.3 66.2-76.2 n = 7	61.4, 69.0

pelvis, a vertebra and a rib, and the long bones of the pectoral skeleton from the left side.

Partial skeleton, BBM-X 153649, including the skull, palatines, pterygoids, quadrates, mandible, furcula, sternum, pelvis, some ribs, vertebrae, and tracheal rings, all of the long bones of the pectoral skeleton except one radius, all of the long bones of the hindlimb except one fibula, plus two pedal and one ungual phalanges.

Partial skeleton, BBM-X 153654, including the skull, mandible, eroded left humerus, and the femora and tarsometatarsi.

Partial skeleton, BBM-X 153648, including the skull and mandible, furcula, eroded sternum and pelvis, and some bone fragments.

Associated mandible and tibiotarsus, BBM-X 153651.

*Measurements of paratypes:* See Table 1.

*Diagnosis:* A large species of *Corvus* with a high, arched bill. The bill is broader and deeper than in *C. woodfordi* or *C. meeki*. Compared to *C. macrorhynchus*, *C. corax*, and *C. moriorum*, the nostril is less elongated anteroposteriorly, the membranes in the nasal cavities are more extensively ossified, and the interorbital septum is not fenestrated. *C. impluviatus* differs further from *C. macrorhynchus* in having the bill shorter and deeper; from *C. corax* in having the bill deeper and the dorsal nasal bar broader; and from *C. moriorum* in having the bill more arched, the cranial fenestra smaller or absent, and the articular end of the mandible larger. Compared to *C. hawaiiensis* and *C. viriosus*, new species, the maxilla is deeper and more arched, the dorsal and lateral nasal bars are wider, the ossification of membranes in the nasal cavities is more extensive (including ossification of the nasal septum, floor of the nasal cavity, and the partial occlusion of the narial openings), the zygomatic process is broader, the olecranon is slimmer, and the posterior projection of the ilium is longer and slimmer. *C. impluviatus* differs further from *C. viriosus* but agrees with *C. hawaiiensis* in having a relatively short bill, with a less excavated ventral surface of the maxilla, a broader frontal, broad postorbital processes, broad and rounded rather than square-tipped transpalatine processes, and the mandible with a shorter symphysis, a more decurved tomial crest, and with a slight ventral projection to the posterior fossa that is not developed in *C. viriosus*.

*Remarks:* The postcranial bones of *C. impluviatus* average longer than those of *C. hawaiiensis* or *C. viriosus*, although the average size difference between *C. impluviatus* and *C. viriosus* is generally slight (Table 1). The short, arched bill and the extensive ossification within the nasal and orbital cavities are very distinctive characters of this species. See further remarks under the following species.

***Corvus viriosus*, new species**  
(Figs. 3C, 4C, 5C, 6C, 7C, 8C, F)

“*Corvus* sp., slender-billed” Olson and James, 1982b:38, 44; 1984:771.

*Holotype:* Partial skeleton, USNM 386435. Collected 26 July 1977 by Storrs L. Olson. The specimen includes the cranium with the maxilla attached (Figs. 3C, 4C, 5C), the palatines, the mandible (Figs. 3C, 6C), the furcula, sternum, and pelvis, four complete ribs and some rib fragments, two thoracic and one caudal vertebrae plus the pygostyle, the right humerus (Fig. 7C), ulna, and carpometacarpus; the left coracoid, radius and first phalanx of the major alar digit; the left femur (Fig. 8C), and both tibiotarsi and tarsometatarsi (Fig. 8F). The bones, which are darker in color and more striated than most other crow bones from the site, are in nearly perfect condition. The skull of this bird was found on the floor of the cavern near the skull and other bones of a specimen of *C. impluviatus*. The mandible and postcranial bones were retrieved from a nearby hole and crevice into which they had slipped.

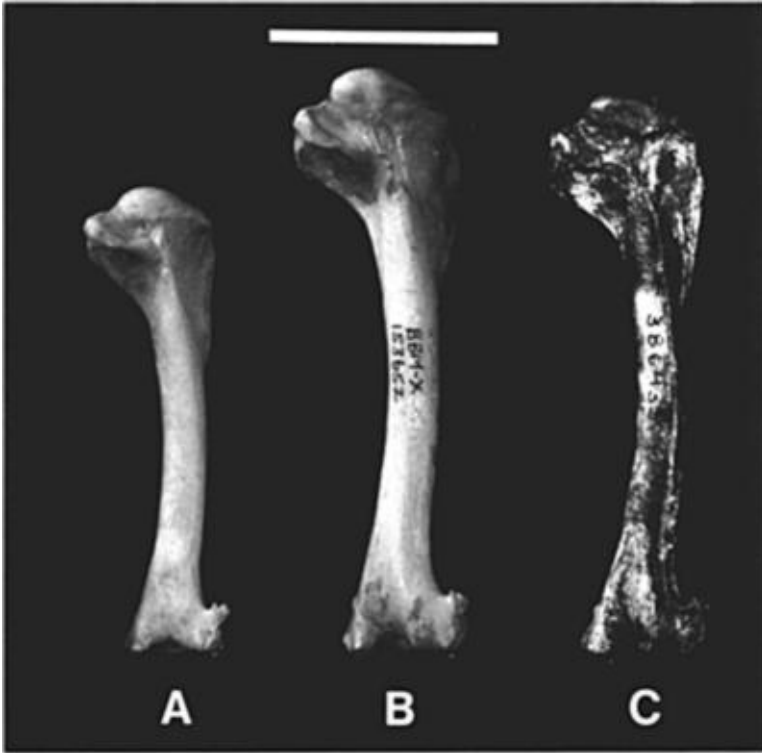

FIG. 7. Humeri of Hawaiian *Corvus* in anconal view. A, *C. hawaiiensis* (USNM 501638); B, *C. impluviatus*, new species, holotype (BBM-X 153652); C, *C. viriosus*, new species, holotype (USNM 386435). Scale = 3 cm.

*Type locality:* Flooded cavern, Site 50-Oa-B6-139, Barbers Point, Oahu, Hawaiian Islands.

*Distribution:* Oahu: Barbers Point (holotype only). Molokai: Moomomi dunes and Ilio Point.

*Etymology:* Latin, *viriosus*, robust, strong; from the larger size of this species compared to *C. hawaiiensis* and from the sturdy construction of the cranium and mandible of Hawaiian corvids generally.

*Measurements (mm) of holotype:* Maxilla: length from anterior narial opening, 46.5; maximum width, 27.0; width of nasofrontal hinge, 22.8; height through lateral nasal bar, 23.3; length of narial opening, 17.6; height of narial opening, 9.6. Cranium: length from supraoccipital to nasofrontal hinge, 44.0; length from supraoccipital to bill tip, 112.6; orbit length (ectethmoid to postorbital process), 24.3; width of frontal between orbit rims, 21.3; width posterior to postorbital processes, 41.0; height from basitemporal plate to skull roof, 28.7; length of basitemporal plate (anterior margin of basitemporal plate to posterior extremity of occipital condyle), 14.7; width between external rims of the articular faces for the quadrates, 38.2. Mandible: length of tomial crest, 56.4; symphysis length, 28.2; greatest width of mandible, 42.3; width of articular end with medial process, 16.2; height at angle of mandible, 14.0; greatest height of sub-rhamphothecal ramus, 13.2.

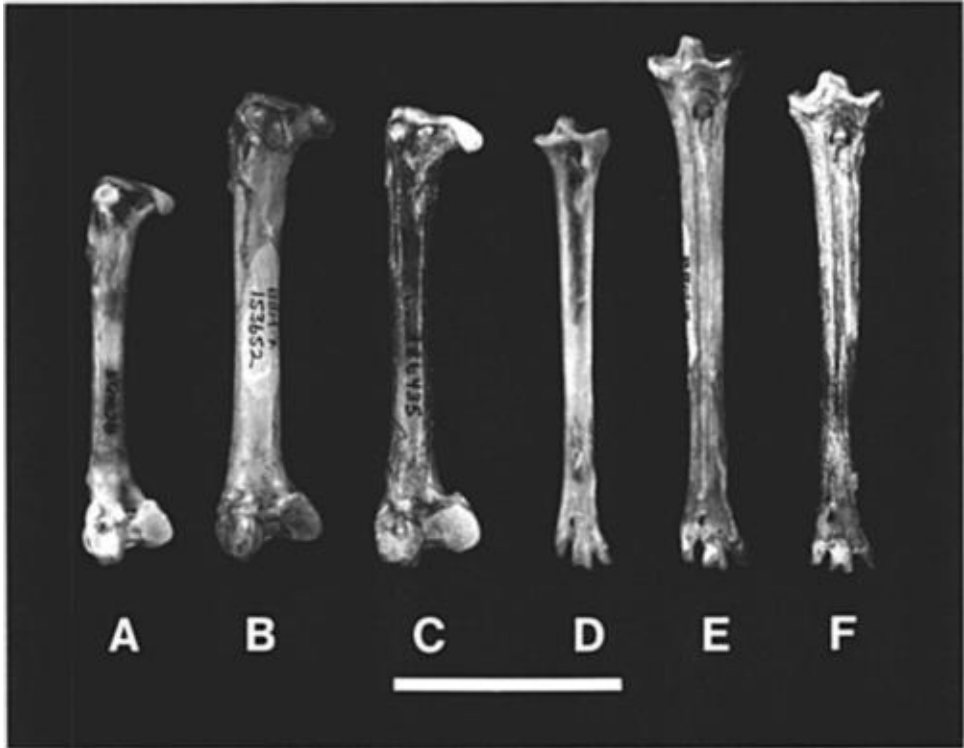

FIG. 8. Bones of the hindlimb of Hawaiian *Corvus*. A, B, C, left femora in posterior view; D, E, F, right tarsometatarsi in anterior view; A, C, *C. hawaiiensis*, small male (USNM 501638); D, *C. hawaiiensis*, large male (USNM 177993); B, E, *C. impluviatus*, new species, holotype (BBM-X 153652); C, F, *C. viriosus*, new species, holotype (USNM 386435). Scale = 3 cm.

Sternum: width below costal facets, 30.3; length of carina, 56.8; depth of carina, 17.4. Coracoid: width of sternal end, 13.2. Humerus: length, 76.1; proximal width, 20.0; length of deltoid crest, 18.6; mid-shaft width, 6.4; distal width, 18.0. Ulna: length, 86.8; proximal width, 11.6; distal width, 10.4. Carpometacarpus: proximal depth, 12.8; distal depth, 11.8. Major alar digit, phalanx 1: length, 22.5. Pelvis: width across antitrochanters, 38.1. Femur: length, 61.9; proximal width, 12.9; mid-shaft depth, 5.1; distal width, 13.9. Tibiotarsus: proximal width, 17.3; length from proximal articulation to distal fibular crest, 31.4; distal width, 11.4. Tarsometatarsus: length, 68.0; proximal width, 11.9; mid-shaft width, 4.8; depth of third trochlea, 5.4.

*Paratype*: Molokai: damaged cranium and associated bones, BBM-X 148156, including part of the fused parietals and frontal with the maxilla attached, the prepalatine bars, the quadrate, and the mandible lacking the right articular end and half of the right dentary.

*Measurements of paratype*: Included in Table 1, along with measurements of other specimens not listed as paratypes.

*Diagnosis*: A large species of *Corvus* with a long, straight bill. The bill is straighter and the dorsal nasal bar is narrower than in *C. woodfordi*. The mandibular ramus is deeper and the tarsometatarsus is shorter than in *C. meeki*. The interorbital



fenestra is smaller and the narial opening is less elongate anteroposteriorly than in *C. macrorhynchus*, *C. corax*, or *C. moriorum*. *C. viriosus* differs further from *C. macrorhynchus* in having the maxillary rostrum less arched anteriorly; from *C. corax* in having the bill deeper, the dorsal nasal bar broader, and the membranes in the nasal cavities more extensively ossified; and from *C. moriorum* in having the cranial fenestra smaller, the ossification of membranes in the nasal cavities more extensive, the mandibular ramus deeper, and the articular end of the mandible larger.

This species differs from *C. hawaiiensis* and *C. impluviatus* in having the bill longer, straighter, and less deep (intermediate in *C. hawaiiensis*), with more pronounced excavation of the ventral maxilla, narrower dorsal and lateral nasal bars (also intermediate in *C. hawaiiensis*), a longer mandibular symphysis, the tomial crest of the mandible nearly straight (gradually curved in *C. hawaiiensis* and *C. impluviatus*), the slight ventral projection of the posterior fossa of the mandible absent, the frontal less broad, the postorbital process slimmer, and the transpalatine process square-tipped (broad and rounded in *C. hawaiiensis* and *C. impluviatus*). The olecranal fossa of the humerus lacks the deep, rounded pit that is present in *C. hawaiiensis* and *C. impluviatus*.

*C. viriosus* differs further from *C. impluviatus*, but agrees with *C. hawaiiensis*, in having a narrower dorsal nasal bar, a relatively slim zygomatic process, a stouter olecranon, and a shorter and broader posterior projection of the ilium.

*Remarks:* The most obvious way to distinguish the three Hawaiian species of *Corvus* is by bill shape: *C. hawaiiensis* has a short, moderately arched bill; *C. impluviatus* has a high, impressively arched bill; and *C. viriosus* has a long, relatively straight bill. On average, the long bones of *C. viriosus* are intermediate in length between the smaller *C. hawaiiensis* and the larger *C. impluviatus*, although there is some overlap with either species (Table 1).

The osteological comparisons we made for the purpose of diagnosing new species were not sufficiently comprehensive to determine the phylogenetic position of the Hawaiian crows relative to species of *Corvus* outside the archipelago. Our impression is that the Hawaiian crows probably did not arise from Nearctic ancestors but may very well have been derived from Australasia, much like *Chasiempis* and the Hawaiian Meliphagidae. We are less confident than previously (Olson and James 1982b:51) that more than one colonizing species gave rise to the Hawaiian corvids.

Family FRINGILLIDAE  
Subfamily CARDUELINAE  
Tribe DREPANIDINI

The monophyly of the Drepanidini is supported by morphological and molecular data (Raikow 1977; Zusi 1978; Johnson et al. 1989), although one authority may still hold out for an independent origin of *Melamprosops phaeosoma* (Pratt 1979). In most cases we had to rely on phenetic resemblance to identify the new fossil taxa as members of this radiation. A few of the fossils were complete enough that derived osteological characters of the interorbital septum and palatine process of the premaxilla could be cited as evidence of cardueline and hence presumably drepanidine affinities. Even for the new species that are placed in the Drepanidini based on phenetics, we are satisfied that this assignment is correct

because each new taxon bears convincing resemblances to one or another branch of the drepanidine radiation. An independent test of our morphological assessment may be feasible if nucleotide sequences can be amplified from drepanidine fossils using the polymerase chain reaction (Pääbo 1989).

Independent studies of myology (Raikow 1976), osteology (Zusi 1978), and DNA-DNA hybridization (Sibley and Ahlquist 1982; Bledsoe 1988) all indicate that the progenitor of the drepanidine radiation is likely to have been a cardueline finch. Although a recent study of allozymes favored a relationship between emberizines and drepanidines (Johnson et al. 1989), the cardueline hypothesis is more highly corroborated, and we have assumed it to be correct. Consequently we place the finch-like taxa first in systematic order, and consider characters shared with carduelines to be primitive within the Drepanidini, although we have not attempted a phylogenetic analysis.

The drepanidines as a group have been recognized by various authors as a distinct family (e.g., Amadon 1950), a subfamily (e.g., Pratt 1979), or a tribe (e.g., Olson and James 1982b; Sibley and Ahlquist 1982). Two subgroups of related species are usually recognized (in Pratt's scheme there are three). These subgroups are designated as subfamilies by Amadon, as tribes by Pratt. Neither of these options is available to us, because we continue to treat the entire radiation itself as a tribe. When we wish to distinguish the two subgroups, we therefore resort to the terminology of Perkins (1903), who was the first to group the predominantly nectarivorous red-and-black birds (*Vestiaria*, *Drepanis*, *Himatione*, *Palmeria*, and *Ciridops*), which he termed Division 1, apart from the rest of the radiation, termed Division 2.

Our present taxonomic treatment of the drepanidines that retain finch-like bills departs from our earlier practice (Olson and James 1982b, 1984; James 1987; James et al. 1987) of lumping these birds into a single genus, *Psittirostra* sensu Amadon (1950), with species-groups treated as subgenera (*Telespiza*, *Loxioides*, *Rhodacanthis*, *Chloridops*, and *Psittirostra*). Instead, we have joined Pratt (1979), the American Ornithologists' Union (1983), and others in recognizing these taxa at the generic level. Arguments in favor of this change are that the genus *Psittirostra* sensu Amadon was united by what now appear to be primitive characters, and that it will make the magnitude of osteological differences between drepanidine genera more comparable to that between continental genera of Carduelinae. At a time when the relationships among the newly increased number of finch-billed species are poorly understood, this has the further advantage of avoiding the use of genera that have a high likelihood of being polyphyletic. In the future it may be advantageous to lump some of the genera recognized here, but when this is done it should be accompanied by evidence of monophyly (sensu Carroll 1987).

Of the drepanidines that have departed from the finch-like bill shape, those with long, overhanging maxillary rostra (*Psittirostra psittacea*, *Dysmorodrepanis munroi*, *Pseudonestor xanthophrys*, *Hemignathus lucidus*, and *Hemignathus wilsoni*) receive little or no mention in our osteological comparisons because none of the new fossil taxa have this condition. The remainder of the drepanidines have thin bills that vary from short to very long, from straight to strongly decurved, and from sturdy to weak. We use the same generic taxonomy for these taxa as we have in previous papers (Olson and James 1982a, b, 1984), except that we have followed the commonly accepted practice of lumping *Heterorhynchus* with *Hem-*

*ignathus*. This is a nomenclatural necessity in any case, because both genera have the same type species.

We have made some minor revisions at the alpha level of taxonomy. The Kauai Amakihi (*Loxops stejnegeri*) is listed as a full species rather than as a subspecies of Common Amakihi (*Loxops virens*), as suggested by osteology and by allozyme data (Johnson et al. 1989). The Kauai Akepa is listed as a distinct species (*Loxops caeruleirostris*). The creepers from Lanai and Maui (*Paroreomyza montana montana* and *P. montana newtoni*) are no longer listed as subspecies of the Oahu Creeper (*Paroreomyza maculata*). These steps were suggested by Pratt (1979), and have been adopted by other authors in whole (Pratt et al. 1987) or in part (Berger 1981; American Ornithologists' Union 1983). Note that we do not accept Pratt's (1979) lumping of the nominal genera *Viridonia* (Greater Amakihi), *Chlorodrepanis* (Common and Kauai Amakihi), and *Magnumma* (Akikiki) with *Hemignathus*, but instead place them with the akepas in *Loxops*. The pattern of differentiation in the individual island populations of akialoas is poorly known, and we have taken the conservative step of listing each named taxon as a species (*Hemignathus stejnegeri*, *H. lichtensteini*, *H. lanaiensis*, and *H. obscurus*).

Accurate identification of passerine fossils is frequently hindered by the great similarity between certain closely related species. This is true to a degree in the Drepanidini, in which morphological evolution of the postcranial skeleton has mainly affected stoutness and intramembral proportions of long bones, especially of the hindlimb. Most finch-billed taxa have stout tarsometatarsi that are relatively short in proportion to femur length, for example, while most thin-billed taxa have thin tarsometatarsi that are relatively long in proportion to femur length. Differences of this sort may be useful for identifying associated skeletons, but usually are not sufficient to allow species-level identification of the isolated postcranial bones that are more frequently encountered in fossil deposits.

On the other hand, the adaptive radiation of the drepanidine feeding apparatus has resulted in dramatic modifications of osteology, such that even small fragments of maxillae and mandibles can often be identified accurately to species. Our descriptions of new drepanidine taxa rely almost entirely on characters of these elements, which preserve well as fossils and are abundantly represented in the Hawaiian deposits.

We have furnished diagnoses based on bill osteology for the genera that contain new species. Characters of the maxilla used in our diagnoses, in addition to general bill shape, include the relative thickness of the dorsal and lateral nasal bars, modifications of the tomial crests, the dimensions and degree of definition of the narial openings, the contour of the posteroventral edge of the bone, the amount of lateral constriction, and the topography and degree of excavation of the ventral surface. Of these, the topography of the ventral surface and the contour of the posteroventral edge require further explanation.

Finch-billed birds typically have the ventral surface of the rhamphotheca on the maxillary rostrum elaborated by some combination of grooves, ridges, troughs, horny plates, serrations, and striations. These structures have frequently been illustrated and correlated with feeding behavior and taxonomy (e.g., Sushkin 1924; Mayr et al. 1956; Bowman 1961; Ziswiler 1965). Although the rhamphothecal covering is missing from the fossil drepanidines, its variations are reflected to some degree in the underlying ventral surface of the bony maxilla, in which the

following structures can be observed in almost all drepanidines: a medial trough extending from the palatine articulations to the tip is bisected sagittally by a medial groove, and is bordered laterally by ventral ridges; small lateral troughs separate these ventral ridges from the tomia of the maxilla; the lateral troughs occlude with the posterior part of the mandibular tomia. Variations in the position and development of these structures are useful taxonomically.

To assist the reader in comparing these structures in the photographic plates, their position in the finch-billed genera is identified diagrammatically in Fig. 9, which also illustrates variation in the contour of the posteroventral edge of the maxilla, ranging from irregular or straight through deeply V-shaped.

Characters of the mandible used in the diagnoses include the degree of lateral constriction, the development of retroarticular processes, the relative size of the articular ends, the bluntness and curvature of the tomial crests, the shape of the middle part of the rami, particularly the relative depth at the angle of the mandible, the shape and thickness of the symphysis, and the shape and angle of the lateral cotylae.

*Comparative material examined:* We were able to examine at least partial skeletal material of nearly all known species of Drepanidini, many of which are now extinct, so that bones had to be obtained from skins by the method outlined in Olson et al. (1987). The only taxa whose osteology was not examined were *Hemignathus lichtensteini* and *H. lanaiensis*: *Telespiza cantans* males, USNM 289279, 289283, 499091, MVZ 148565; females, USNM 289280, 501414, 501648, 553311, MVZ 148564, PB 23537; unsexed, USNM 289281, 289282, 289284, 502155, 502223, AMNH 8882, 9060. *T. ultima* male, USNM 289278; females, USNM 289277, MVZ 124728, 124729, 124730. *Loxioides bailleui* males, MVZ 118827, 122620, 122621; probable females, USNM 560602, MVZ 118826, BBM-X 156555; unsexed, USNM 19098. *Chloridops kona* male, AMNH 453677 (bones removed from skin). *Rhodacanthus palmeri* male, AMNH 453623 (bones removed from skin). *R. flaviceps* female, AMNH 453644 (bones removed from skin). *Melamprosops phaeosoma* probable male, AMNH 810456 (bones removed from skin and from alcoholic trunk, AMNH 6371 [same individual]); unsexed, USNM 384745 (a nearly complete associated fossil skeleton from Auwahi Cave). *Psittirostra psittacea* male, MVZ 122619; unsexed, USNM 111454 (bones removed from skin). *Dysmorodrepanis munroi*, BBM 4792 (bones removed from skin). *Pseudonestor xanthophrys* male, BMNH S/1961.11.46; female, BMNH S/1961.11.40. *Hemignathus lucidus* unsexed, BMNH S/1961/11.39. *H. wilsoni* male, MVZ 122610; female, MVZ 118830; unsexed, 122611. *H. stejnegeri* (= *H. procerus* auct.) unsexed, USNM 19094, 19095 (bones removed from alcoholic specimen). *H. obscurus* male, BBM 4434 (bones removed from skin); unsexed, BBM 109 (bones removed from skin). *Oreomystis bairdi* males, USNM 553183, BBM 1231; unsexed, USNM 19096 (bones removed from alcoholic specimen), 19097. *Paroreomyza maculata* (Oahu) unsexed, AMNH 5968. *P. montana newtoni* males, USNM 502187, 502188, 502189, MVZ 122615, 122616. *P. flammea* unsexed, AMNH 453314 (bones removed from skin). *Loxops caeruleirostris* males, USNM 553186, BBM 1229. *L. coccineus coccineus* male, MVZ 122613; unsexed, AMNH 9192. *L. mana* males, MVZ 122614, 118823. *L. parvus* males, USNM 553187, 553188, 553189, 553191; females, USNM 502211, 553190; unsexed, USNM 19136. *L. stejnegeri* males, USNM 502195, 553192, 553194, 553196; females,

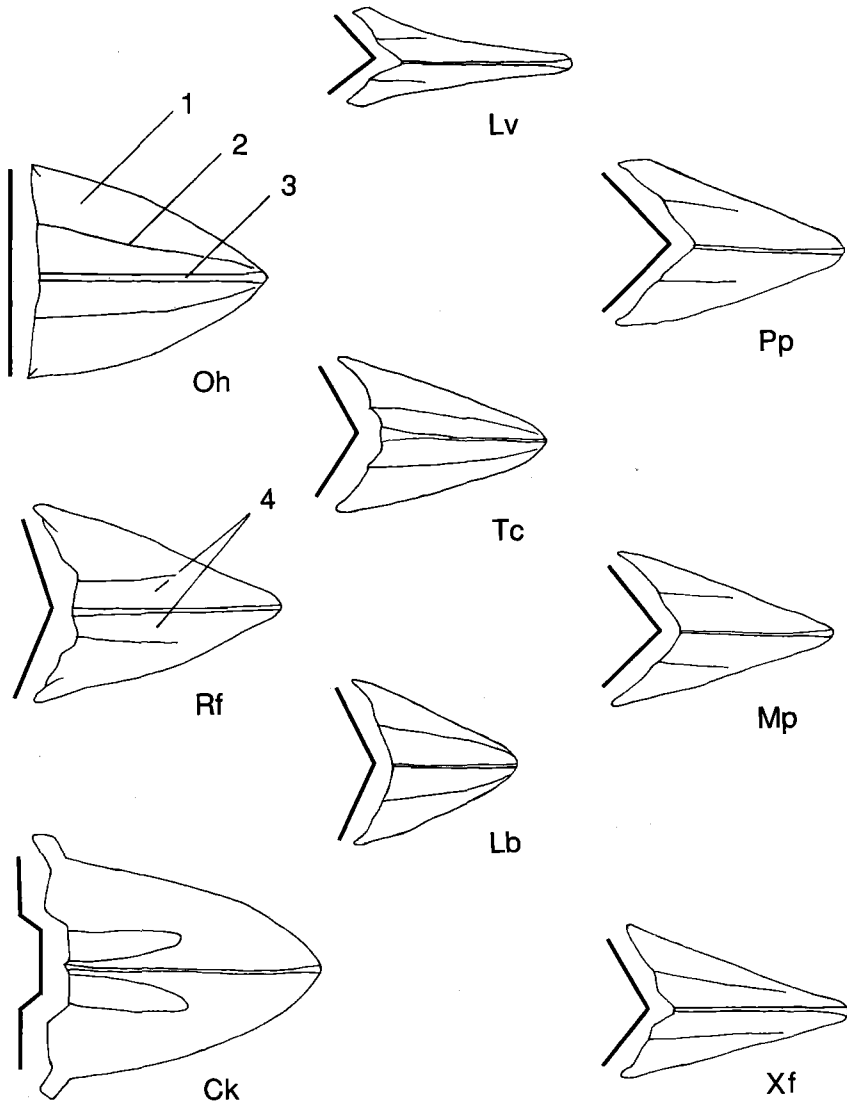

FIG. 9. Ventral maxillae of the finch-like genera of drepanidines, with *Loxops virens* for comparison. Bold lines illustrate the contour of the posteroventral margin of the maxilla, which can be straight (Oh), irregular (Ck), shallowly V-shaped (Rf, Tc, Lb), or more steeply V-shaped (Xf, Mp, Pp, and Lv, progressively). The following topographic features also vary in development among genera, as discussed in the text: 1, lateral trough; 2, ventral ridge; 3, medial groove; 4, medial trough. Oh, *Orthospiza howarthi*; Rf, *Rhodacanthis flaviceps*; Ck, *Chloridops kona*; Lv, *Loxops virens*; Tc, *Telespiza cantans*; Lb, *Loxioides bailleui*; Pp, *Psittirostra psittacea*; Mp, *Melamprosops phaeosoma*; Xf, *Xestospiza fastigialis*.

USNM 502196, 553193, 553195; unsexed, USNM 502194. *L. virens flavus* (= *L. virens chloris* auct.) females, USNM 553201, 553202, 553203, BBM-X 145538. *L. v. wilsoni* males, USNM 502191, 502192, 502193; female, USNM 502190. *L. v. virens* males, USNM 502197, 553209, 553210, 553213, 553214, MVZ 118755, 118760, 118766, 118767, 118782, 118786, 118787, 118788, PB 23868, 23869;

females, USNM 502198, 553211, MVZ 118756, 118761, 118762, 118763, 118765, 118772, 118814, PB 23870; unsexed, MVZ 118759, AMNH 9193, 9194, 9197. *L. sagittirostris* unsexed, AMNH 453236 (bones removed from skin). *Vestiaria coccinea* males, USNM 502199, 502200, 502201, 502204, 553184, 553185, 553205, MVZ 118948, 118950, 118974, PB 23864, 23865; females, USNM 502202, 502203, MVZ 118942, 118949, 118955, PB 23867; unsexed, USNM 19130. *Drepanis funerea* male, BBM 4712 (bones removed from skin). *D. pacifica* unsexed, BBM 2 (skull removed from skin). *Himatione freethii* unsexed, USNM 301141 (bones removed from skin), 301142 (bones removed from skin), 346246. *H. sanguinea* males, USNM 502205, 502206, 502207, 502209, 553182, 553217, 553218, MVZ 118858, 118883, 118885, 118886, 118927, PB 23861, 23862; females, USNM 502210, 553215, MVZ 118866, 118874, 118875, 118876, 118887, 118891; unsexed, USNM 19092, 553219, 502208. *Palmeria dolei* female, MVZ 122608. *Ciridops anna* unsexed, MCZ 19095 (bones removed from skin); BMNH 1939.12.9.58 (bones removed from alcoholic trunk specimen).

#### Genus *Telespiza* Wilson, 1890

Fossil evidence has shown that the genus *Telespiza* was not always restricted in distribution to the Northwestern Hawaiian Islands but was widely distributed in the main chain of islands during the Holocene (Olson and James 1982b:39). Two new species from the main islands are described here, both smaller than the extant forms. In addition we have noted the existence of a possible third species, even smaller, of which we have only one mandibular ramus from Maui.

The four species of *Telespiza* hardly differ from each other in bill shape. Whereas other new drepanidines are diagnosed on qualitative osteological characters, the new species in this genus are diagnosed mainly on differences in bill size. To document size variation, we have included a longer list of paratypes and more osteometric data for this genus. We observed no overlap between any two species of *Telespiza* in the length of the maxilla measured from the lateral corner of the nasofrontal hinge, or the length of the mandible, although some overlap exists in other bill measurements (Tables 2 and 3, Fig. 10).

Modern taxonomic practice would allow for allopatric populations that are differentiated mainly on size to be accommodated in one polytypic species. We recognize the new forms as full species because, even with the very patchy fossil record now available, three of the four taxa in the genus are known to have been sympatric with each other (Table 4).

In the following generic diagnosis of *Telespiza* we have restricted our comparisons to other finch-like drepanidine genera. Compared to *Melamprosops* and *Psittirostra*, the narial opening is subcircular rather than oval, the dorsal nasal bar is broader and sturdier, the ventral surface of the maxilla is less excavated, the ventral ridges of the maxilla extend nearly to the tip rather than being confined posterolaterally, the posteroventral edge of the maxilla is less deeply V-shaped, and the mandibular tomium is more curved posteriorly. In addition, the maxillary rostrum does not overhang the mandibular rostrum in *Telespiza* to the same extent as in *Psittirostra*, and the lateral cotyla of the mandible is wider. Compared to *Rhodacanthis*, the bill is narrower, the dorsal nasal bar is broader and sturdier, the ventral ridges of the maxilla are not as prominent but are longer, extending nearly to the tip of the bill, and the medial trough of the maxilla is less excavated.

TABLE 2

MEASUREMENTS (MM) OF THE MAXILLA IN *Telespiza* AND *Loxioides*. MEAN, STANDARD DEVIATION, AND RANGE ARE GIVEN FOR SAMPLE SIZES GREATER THAN 4; DATA ARE LISTED INDIVIDUALLY FOR SAMPLE SIZES OF 4 OR FEWER.

H = HOLOTYPE

	<i>Telespiza cantans</i>	<i>Telespiza ultima</i>	<i>Telespiza persecutrix</i>	<i>Telespiza ypsilon</i>	<i>Loxioides bailleui</i>
Dorsal length	15.6 ± 0.4 14.9-16.3 n = 8	13.1 ± 0.4 12.8-13.6 n = 5	11.4 ± 0.5 10.7-11.9 n = 5	9.7 ± 0.6 9.0-10.5 n = 5	12.9 ± 0.2 12.6-13.2 n = 7
Ventral length	9.0 ± 0.4 8.1-9.5 n = 8	7.1 ± 0.3 6.8-7.6 n = 5	6.8 ± 0.6 6.1-7.6 n = 7	5.3, 5.5 H, 5.5, 5.8	6.2 ± 0.3 5.8-6.6 n = 7
Length from lateral corner of nasofrontal hinge	15.5 ± 0.4 14.9-16.0 n = 8	13.4 ± 0.3 13.0-13.8 n = 5	11.8 ± 0.4 11.2-12.3 n = 5	9.4, 9.7 H, 9.9, 10.5	12.8 ± 0.2 12.5-13.2 n = 7
Length from jugal articulation	11.7 ± 0.4 10.7-12.2 n = 8	9.4 ± 0.3 9.1-9.4 n = 5	8.5 ± 0.5 7.8-9.2 n = 7	7.4 ± 0.4 7.1-8.2 n = 5	8.8 ± 0.3 8.2-9.1 n = 7
Length from anterior narial opening	9.0 ± 0.3 8.4-9.4 n = 8	7.4 ± 0.3 7.1-7.7 n = 5	6.7 ± 0.4 5.9-7.4 n = 7	5.6 ± 0.4 5.3-6.4 n = 5	6.3 ± 0.1 6.1-6.5 n = 7
Maximum width	8.2 ± 0.4 7.8-8.8 n = 8	6.9 ± 0.3 6.6-7.3 n = 5	6.4 ± 0.3 6.1-7.1 n = 9	5.5 ± 0.2 5.3-5.7 n = 5	8.1 ± 0.2 7.9-8.4 n = 6
Width of nasofrontal hinge	9.1 ± 0.5 8.7-10.3 n = 8	7.3 ± 0.2 7.0-7.6 n = 5	6.8 ± 0.6 6.3-7.7 n = 5	5.3, 5.5, 5.8 H	8.3 ± 0.2 8.0-8.7 n = 7
Length of narial opening	3.5 ± 0.2 3.1-3.7 n = 8	3.1 ± 0.2 3.0-3.4 n = 5	2.9 ± 0.2 2.5-3.1 n = 9	2.9 ± 0.2 2.7-3.1 n = 7	3.9 ± 0.2 3.6-4.2 n = 6
Height of narial opening	3.4 ± 0.2 3.2-3.7 n = 8	2.8 ± 0.1 2.7-2.9 n = 5	2.6 ± 0.1 2.4-2.8 n = 8	2.4 ± 0.2 2.2-2.7 n = 7	3.5 ± 0.2 3.1-3.7 n = 6
Height through lateral nasal bar	7.3 ± 0.4 6.7-7.7 n = 8	6.3 ± 0.3 6.0-6.7 n = 5	5.1 ± 0.3 4.6-5.5 n = 6	4.0 ± 0.4 3.5-4.5 n = 5	6.7 ± 0.3 6.5-7.1 n = 6
Minimum width of dorsal nasal bar	2.4 ± 0.2 2.2-2.7 n = 8	2.0 ± 0.1 1.8-2.2 n = 5	1.9 ± 0.2 1.7-2.2 n = 8	1.5 ± 0.1 1.3-1.6 n = 7	2.3 ± 0.2 2.0-2.6 n = 7

Compared to *Chloridops*, the bill is less robust overall, the ventral ridges of the maxilla are longer but less prominent, and the tomial crest of the mandible is evenly decurved rather than nearly straight or ascending in the posterior portion. *Telespiza* is distinguished from *Orthospiza* by the presence of a ventral trough of the maxilla, the much smaller narial openings, the shallowly V-shaped rather than straight posteroventral edge of the maxilla, the sturdier nasal bars, the less pointed mandible, and the less curved mandibular tomium. The bill of *Telespiza* is most similar to that of *Loxioides*, from which it differs by being longer and narrower rather than distinctly foreshortened, having a slightly wider lateral cotyla and a less abruptly decurved tomial crest of the mandible. These are relatively minor differences, so that it may be appropriate in the future to merge *Telespiza*

TABLE 3  
 MEASUREMENTS (MM) OF THE MANDIBLE IN *Telespiza* AND *Loxioides*. MEAN, STANDARD DEVIATION, AND RANGE ARE GIVEN FOR SAMPLE SIZES GREATER THAN 4; DATA ARE LISTED INDIVIDUALLY FOR SAMPLE SIZES OF 4 OR FEWER

	<i>Telespiza cantans</i>	<i>Telespiza ultima</i>	<i>Telespiza persecurix</i>	<i>Telespiza ypsilon</i>	<i>Telespiza aff. ypsilon</i>	<i>Loxioides bailleui</i>
Total length	24.9 ± 0.6 24.3-26.2 n = 8	20.4 ± 0.2 20.2-20.6 n = 5	19.0 ± 0.5 18.4-19.9 n = 5	17.4	14.0	21.6 ± 0.6 20.8-22.1 n = 5
Length of tomial crest	11.6 ± 0.3 11.2-12.0 n = 8	9.3 ± 0.2 9.2-9.6 n = 5	8.4 ± 0.5 7.4-9.2 n = 8	7.3, 7.7, 7.7	5.7	8.4 ± 0.4 8.0-9.0 n = 6
Symphysis length	7.8 ± 0.3 7.5-8.3 n = 8	6.3 ± 0.2 6.0-6.5 n = 5	5.5 ± 0.4 4.7-6.1 n = 8	4.4, 4.6, 4.8	-	4.7 ± 0.1 4.5-5.0 n = 6
Greatest width of symphysis	9.7 ± 0.3 9.3-10.1 n = 8	7.7 ± 0.3 7.5-8.3 n = 5	7.2 ± 0.4 6.9-7.9 n = 7	6.4	-	8.4 ± 0.2 8.2-8.8 n = 6
Symphysis height	4.6 ± 0.2 4.4-4.9 n = 8	3.9 ± 0.2 3.6-4.3 n = 5	3.5 ± 0.3 3.0-3.8 n = 7	2.4, 2.5, 2.8	2.0	4.0 ± 0.1 3.8-4.2 n = 6
Length of lateral cotyla	3.2 ± 0.1 3.1-3.4 n = 8	2.6 ± 0.1 2.5-2.6 n = 5	2.6 ± 0.2 2.4-2.8 n = 5	2.2	2.0	3.4 ± 0.4 3.0-3.9 n = 5
Width of articular end with medial process	5.3 ± 0.2 4.9-5.6 n = 8	4.2 ± 0.1 4.0-4.4 n = 5	3.7, 4.1, 4.5	3.6	-	4.6 ± 0.1 4.5-4.9 n = 5
Height at lateral cotyla	2.4 ± 0.2 1.9-2.6 n = 8	1.8 ± 0.1 1.7-1.9 n = 5	1.7 ± 0.2 1.5-2.0 n = 6	1.6	1.0	2.1 ± 0.2 1.9-2.3 n = 5
Height at angle of mandible	5.6 ± 0.3 5.2-6.1 n = 8	4.5 ± 0.1 4.3-4.6 n = 5	4.3 ± 0.4 4.0-5.0 n = 6	3.6	2.7	4.1 ± 0.2 3.9-4.4 n = 5
Ramus length (middle part)	11.6 ± 0.4 11.3-12.4 n = 8	10.1 ± 0.3 9.7-10.4 n = 5	9.1 ± 0.4 8.6-9.5 n = 6	9.2	7.0	11.2 ± 0.3 10.8-11.5 n = 5



TABLE 4  
THE DISTRIBUTION OF SPECIES IN THE GENUS *Telespiza*. INTRODUCED  
POPULATIONS ARE NOT INDICATED. X = EXTANT, † = FOSSIL

	Laysan	Nihoa	Kauai	Oahu	Molokai	Maui
<i>T. cantans</i>	X			†	†	
<i>T. ultima</i>		X			†	
<i>T. persecutrix</i>			†	†		
<i>T. ypsilon</i>					†	†
<i>T. aff. ypsilon</i>						†

with *Loxioides* once again. For use of the spelling *Telespiza* as opposed to *Telespyza*, see Olson and James (1986).

***Telespiza persecutrix*, new species**  
(Figs. 11G–J, 12B, 13B)

“*Psittirostra (Telespyza)*, medium species” Olson and James, 1982b:39, 45; 1984:771; James, 1987:225.

*Holotype*: Nearly complete maxilla lacking the dorsal nasal bar, with the ectethmoids and part of the frontal attached, BPBM 158882 (Fig. 11G–I). Collected 23 July 1981 by A. Sinoto and P. C. McCoy.

*Type locality*: Site 50-Oa-B6-22, Barbers Point, Oahu, Hawaiian Islands.

*Distribution*: Kauai: Makawehi Dunes. Oahu: Barbers Point and Ulupau Head.

*Etymology*: Latin, *persecutrix*, one who follows pertinaciously; a sequel to the name *T. ultima* Bryan, 1917, given to the Nihoa Finch in the mistaken expectation that “the species under consideration is very liable to be the last native passerine bird to be discovered in the Hawaiian Group” (Bryan 1917:70–71). Bryan’s new finch was followed by the Nihoa Millerbird, *Acrocephalus (familiaris) kingi* (Wetmore, 1924), the drepanidines *Dysmorodrepanis munroi* Perkins, 1919 (collected in 1913), and *Melamprosops phaeosoma* Casey and Jacobi, 1974, and now by many new fossil species. The name is a feminine noun in apposition.

*Measurements (mm) of holotype*: Dorsal length, 11.4; ventral length, 6.4; length from lateral corner of nasofrontal hinge, 11.6; length from jugal articulation, 8.1; length from anterior narial opening, 6.7; maximum ventral width, 6.7; width of nasofrontal hinge, 6.4; length of narial opening, 2.5; height through lateral nasal bar, 5.3.

*Paratypes*: Oahu: three complete maxillae, BPBM 177239, 177250 and 177254; maxilla with the cofused nasals broken posteriorly, BPBM 177240; maxilla lacking the left and part of the right nasal bars, USNM 255230; maxilla lacking the left nasal bar, USNM 255562 (Fig. 11J); maxilla lacking the left nasal bar, BBM-X 155603; maxilla lacking the tip, BBM-X 153707; nearly intact juvenile maxilla, BBM-X 155885; mandible lacking part of the right ramus, BPBM 177255; mandible lacking part of the left ramus, BPBM 177158; mandible lacking parts of the right ramus and left articular end, USNM 255208; two mandibular symphyses, USNM 255586 and BPBM 177194; mandible lacking part of the left ramus, USNM 447060 (Figs. 12B, 13B).

Kauai: Two mandibles, each lacking part of the right ramus, USNM 253888 and BBM-X 152693.

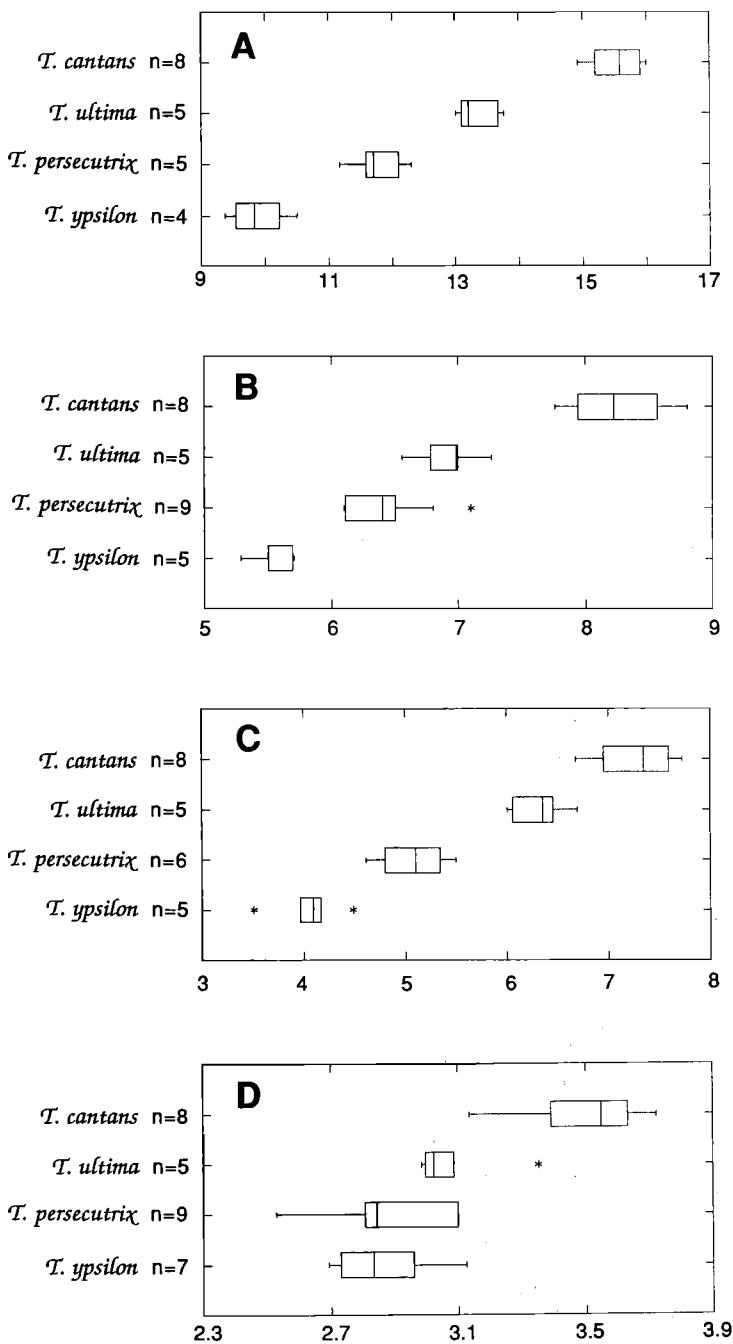
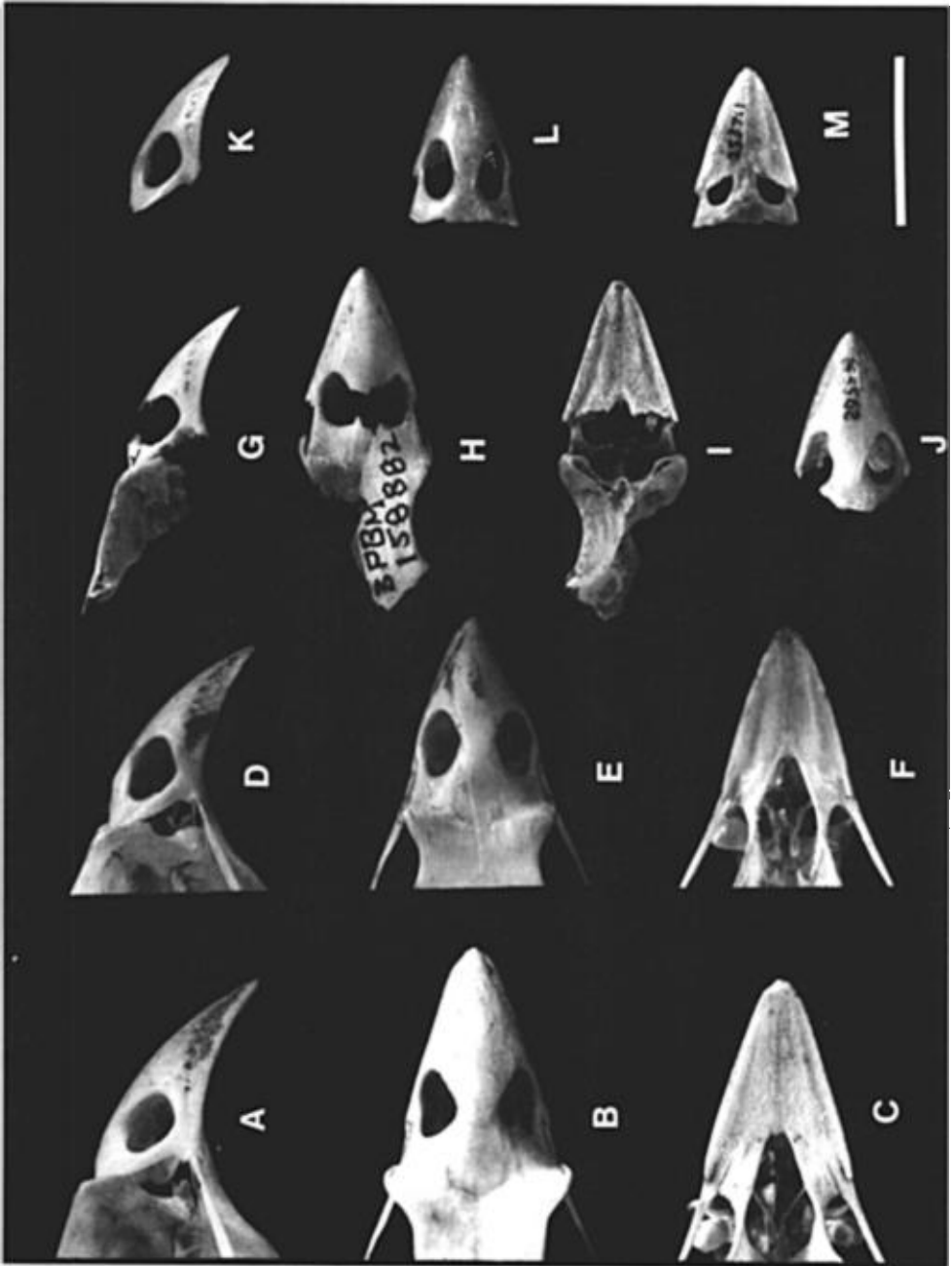

FIG. 10. Box plots of measurements (mm) of the maxilla in *Telespiza*. The boxes indicate 25% of the range of values on each side of the median, the vertical line is the median, the horizontal line denotes the range of values, and outliers are indicated by an asterisk. A, length from lateral corner of nasofrontal hinge; B, maximum width; C, height through lateral nasal bar; D, length of narial opening.



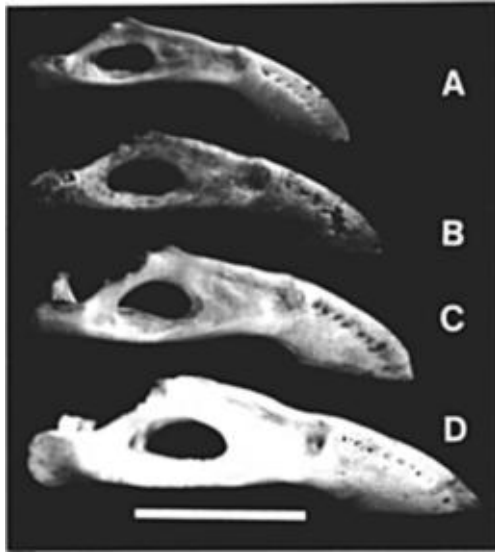

FIG. 12. Mandibles of *Telespiza* in lateral view. A, *T. ypsilon*, new species (image is of the left side printed in reverse, USNM 254736); B, *T. persecutrix*, new species (USNM 447060); C, *T. ultima*, female (MVZ 124728); D, *T. cantans*, female (USNM 253711). Scale = 1 cm.

*Measurements of paratypes:* See Tables 2 and 3 and Fig. 10.

*Diagnosis:* The bill is smaller than in *T. cantans* or *T. ultima*, but larger than in *T. ypsilon*, new species. Compared to *T. ypsilon*, the narial opening is slightly smaller in proportion to the overall size of the maxilla.

*Remarks:* Of all the new species of drepanidines, this is the least differentiated in bill osteology. Nevertheless, the size differences between the three taxa are statistically significant. MANOVA F statistics comparing four measurements of the maxilla in *T. ultima* vs *T. persecutrix* and *T. persecutrix* vs *T. ypsilon* had a probability level of 0.01 (Wilks' Lambda), despite small sample sizes of four to five.

The distribution of *T. ultima*, which is known from fossils to have occurred on islands to the east and west of *T. persecutrix*, argues that these two taxa are not subspecies. It is at least as plausible that *T. ultima* formerly had a continuous distribution and was thus sympatric with *T. persecutrix*.

Recognizing *T. persecutrix* as a distinct species serves to emphasize that members of this genus were evidently widely distributed and that a high degree of sympatry existed among them. It is also consistent with the modern reversal of opinion regarding *T. ultima*, which was long treated as a subspecies of *T. cantans* but is now considered to be a distinct species because of differences in size,

←

FIG. 11. Maxillae of *Telespiza* in three views. A, lateral, B, dorsal, and C, ventral views of *T. cantans*, female (MVZ 148564); D, lateral, E, dorsal, and F, ventral views of *T. ultima*, female (MVZ 124728); G, lateral, H, dorsal, and I, ventral views of *T. persecutrix*, new species, holotype (BPBM 158882); J, dorsal view of *T. persecutrix* (USNM 255562); K, lateral, L, dorsal, and M, ventral views of *T. ypsilon*, new species, holotype (USNM 253711). Scale = 1 cm.



FIG. 13. Mandibles of *Telespiza* in dorsal view. A, *T. ypsilon*, new species (USNM 254736); B, *T. persecutrix*, new species (447060); C, *T. ultima*, female (MVZ 124728); D, *T. cantans*, female (USNM 253711). Scale = 1 cm.

plumage, and plumage sequence (Banks and Laybourne 1977), as well as by its fossil sympatry with *T. cantans* on Molokai (Olson and James 1982b). All of the named species of *Telespiza* occur on more than one island, and three of the four were found together on Molokai (Table 4). As the fossil record improves, we might expect to find three or more species on each of the main islands.

***Telespiza ypsilon*, new species**  
(Figs. 11K–M, 12A, 13A)

“*Psittirostra (Telespyza)*, small species” Olson and James, 1982b:39, 45; 1984:772.

**Holotype:** Complete maxilla, USNM 253711 (Fig. 11K–M). Collected 12 or 19 July 1976 by Storrs L. Olson and Joan Aidem.

**Type locality:** Site 20, Ilio Point, Molokai, Hawaiian Islands.

**Distribution:** Molokai: Ilio Point. Maui: Puu Naio Cave.

**Etymology:** Greek, *ypsilon*, twentieth letter of the Greek alphabet, in reference to the number of the type locality. The name is a neuter noun in apposition.

**Measurements (mm) of holotype:** Dorsal length, 9.3; length from jugal articulation, 7.3; length from anterior narial opening, 5.3; maximum ventral width, 5.5; length of narial opening, 2.9; height of narial opening, 2.2; height through lateral nasal bar, 4.1; minimum width of dorsal nasal bar, 1.3. For additional measurements, see Table 2.

**Paratypes:** Molokai, Ilio Point: complete maxilla with tip slightly abraded, USNM 253712; nearly complete maxilla lacking tip, USNM 254698; maxilla lacking right nasal bar and ventral rim of right narial opening, USNM 254850; maxilla lacking right nasal bar, USNM 445779; maxilla lacking tip and left nasal bar, BPBM 178140; maxilla lacking right nasal bar, BPBM 178141; mandible lacking parts of the symphysis and right ramus, USNM 254736 (Figs. 12A, 13A); mandible lacking parts of both rami, USNM 255013.

Maui, Puu Naio Cave: The portion of a maxilla anterior to the narial openings, USNM 445780; mandibular symphysis, USNM 445781.

**Measurements of paratypes:** See Tables 2 and 3 and Fig. 10.

**Diagnosis:** The bill is smaller overall, and the narial openings are somewhat enlarged relative to the size of the maxilla, compared to *Telespiza cantans*, *T. ultima*, or *T. persecutrix*.

**Remarks:** *T. ypsilon* was by far the commonest passerine prey item of the long-legged owl, *Grallistrix geleches*, in the pellet deposits at Ilio Point on Molokai. One hundred and thirty-one pieces of the bill of this species were identified from Sites 16 and 20, making up 53% of the minimum number of individual drepanidines, which suggests that *T. ypsilon* was fairly abundant in this harsh, arid environment. The species was not restricted to extremely arid coastal habitats, however, as the specimens from Puu Naio Cave on Maui originated at about 305 m elevation in a region of more moderate climate.

*Telespiza* aff. *ypsilon*, Maui

**Material:** A left mandibular ramus, USNM 445782.

**Distribution:** East Maui: Lua Lepo.

**Measurements:** See Table 3.

**Remarks:** This specimen is 22% smaller than the next larger specimen of *Telespiza* (*T. ypsilon*), based on the average difference between seven measurements compared in Table 3. In all likelihood it represents a distinct species.

The specimen is also notable as an elevational record, because it was found at a much higher elevation (808 m) than any locality where *Telespiza* has previously been reported. Besides this record and the few specimens of *T. ypsilon* from Puu Naio Cave (305 m), the genus is known only from localities near sea level.

Genus *Chloridops* Wilson, 1888

In *Chloridops* the bill is robust and heavily ossified, to an extent comparable to continental grosbeaks. The thick walls of the maxilla and mandibular symphysis encase a dense network of uncommonly sturdy bony trabeculae that presumably functioned to disperse the strong forces generated when cracking hard seeds with the bill. The relatively straight tomial crest of the maxilla, with a slight to marked ventral bulge about one-third of the distance from the tip, distinguishes *Chloridops* from all related genera, in which the tomial crest is evenly decurved. Prominent but blunt ventral ridges of the maxilla are also unique to *Chloridops*. These ridges are prominent but sharp in *Rhodacanthis*, and are more weakly developed in all other drepanidines. In *Chloridops*, the narial opening is never elongate antero-posteriorly, but usually resembles *Telespiza*, *Loxioides*, and *Rhodacanthis* in being subcircular, while in *C. regiskongi*, new species, the narial opening is markedly higher than it is long. The mandible in *Chloridops* is extremely robust, with the walls of the bony symphysis thicker, the ramus deeper in relation to its length, and the articular end enlarged, compared to other drepanidines. The anterior edge of the symphysis is broadly curved rather than pointed, a condition also found in *Loxioides*. The posterior third of the tomial crest of the mandible is blunt or flattened to a greater degree than in other drepanidines.

*Chloridops* sp., Kauai

"*Psittirostra* (*Chloridops*), Kauai species" Olson and James, 1982b:40, 44.

"*Psitirostra* [sic] (*Chloridops*), Kauai sp." Olson and James, 1984:771.

*Material*: Symphysis and left ramus of a damaged mandible, USNM 253929; the middle part of a right ramus, USNM 254980; right ramus without symphysis, USNM 253904; two fragments of palatines, USNM 254988 and 254989; two right quadrates, USNM 254981 and 445783; left quadrate, USNM 254982.

*Distribution*: Kauai: Makawehi Dunes.

*Measurements*: See Table 6.

*Remarks*: The mandible is similar to that of *Chloridops wahi*, new species, except that the lingual walls of the mandibular symphysis are more widely set apart, creating a broader lingual trough. Although this difference between *C. wahi* and the mandible from Kauai is quite striking, a larger sample is needed to evaluate how much variation may occur within species. It is not unlikely that the Kauai *Chloridops* is a distinct species, because intraspecific variation of this magnitude is not apparent in the series of mandibles of *C. regiskongi*, new species. In any case, the narrower lingual trough is present only in *C. wahi* and *C. kona*; the trough is wider in other forms of *Chloridops*.

*Chloridops wahi*, new species

(Figs. 14A, 15C, D, 16A)

"*Psittirostra* (*Chloridops*), lesser Oahu species" (Olson and James, 1982b: 40, 45; 1984: 771; James, 1987:225, 228.

*Holotype*: Nearly intact maxilla lacking a small part of the left nasal, BBM-X 155524 (Figs. 14A, 16A). Collected July or August 1977 by Aki Sinoto.

*Type locality*: Site 50-Oa-B6-100B, Barbers Point, Oahu, Hawaiian Islands.

*Distribution*: Oahu: Barbers Point and Ulupau Head. Maui: Puu Naio Cave.

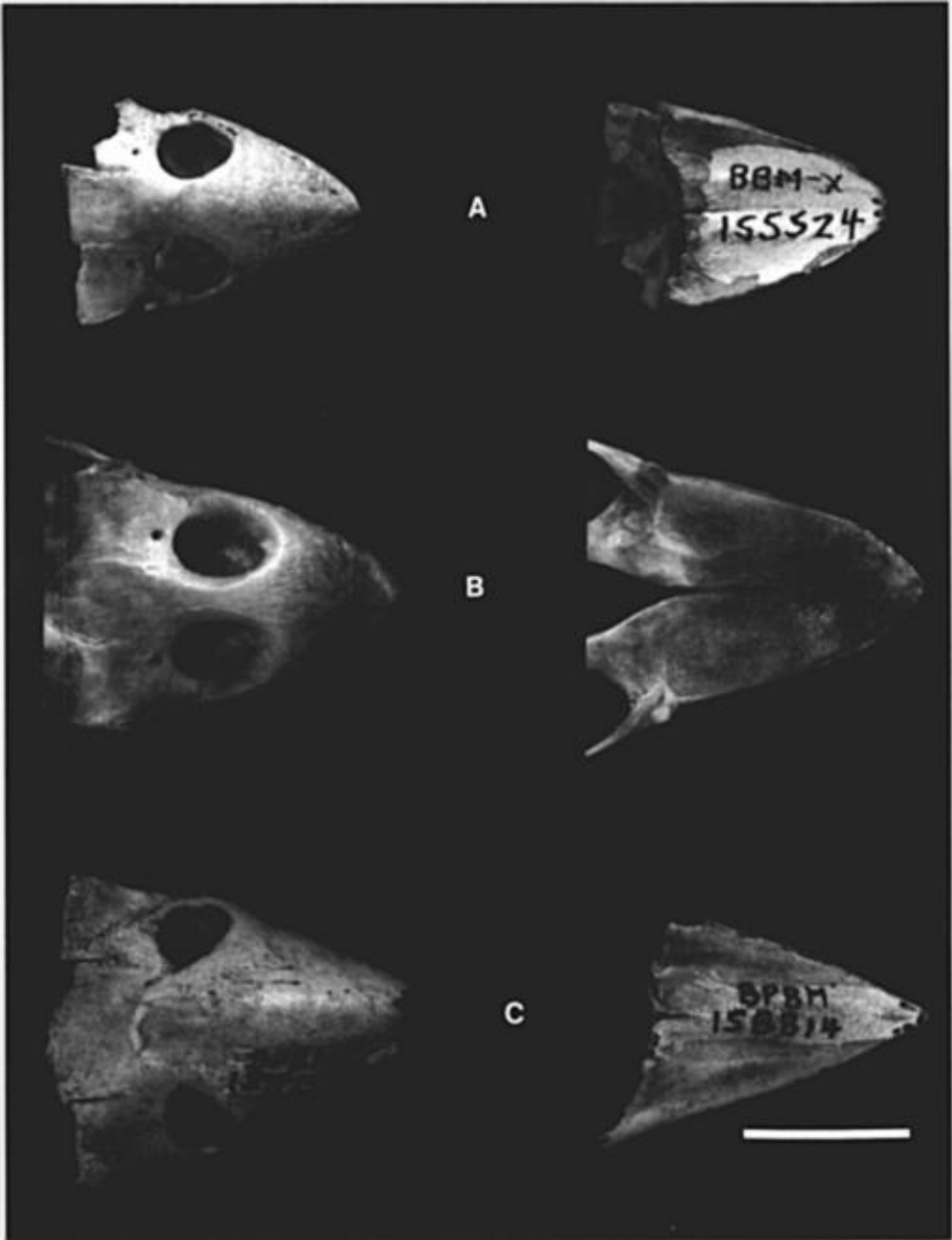

FIG. 14. Maxillae of *Chloridops* in dorsal (left) and ventral (right) views. A, *C. wahi*, new species, holotype (BBM-X 155524); B, *C. kona*, male (AMNH 453677); C, *C. regiskongi*, new species (dorsal view is of holotype, BPBM 158742; ventral view is of BPBM 158814). Scale = 1 cm.

*Etymology*: Hawaiian, *wahi*, to cleave or break in pieces; in reference to the function of the bill in cracking hard seeds.

*Measurements of holotype*: See Table 5.

*Paratypes*: Oahu, Barbers Point: maxilla lacking part of nasals, USNM 255568; nearly intact maxilla, BBM-X 155155; articular end of mandible lacking medial





TABLE 5

MEASUREMENTS (MM) OF THE MAXILLA IN *Chloridops*. THE MEASUREMENTS IN PARENTHESES ARE ESTIMATES DUE TO THE MISSING TIP OF THE MAXILLA IN THE HOLOTYPE OF *C. regiskongi*. H = HOLOTYPE

	<i>Chloridops wahi</i> , Oahu	<i>Chloridops wahi</i> , Maui	<i>Chloridops kona</i>	<i>Chloridops regiskongi</i>
Dorsal length	18.4 H	18.5	22.2	(25.5 H)
Ventral length	11.7 H	12.0	12.8	(14.9 H)
Length from lateral corner of nasofrontal hinge	18.8 H	18.9	22.1	(25.2 H)
Length from jugal articulation	14.4 H	14.0	16.0	(18.6 H)
Length from anterior narial opening	10.2 H	9.7	11.8	(16.2 H)
Maximum width	12.2 H, 12.4, 12.5	12.5	13.2	14.9 H
Width of nasofrontal hinge	12.3	—	12.3	16.2 H
Length of narial opening	3.9 H, 4.0, 4.4	4.3	4.6	3.6 H
Height of narial opening	3.8 H, 3.8, 3.9	4.3	4.4	5.5 H
Height through lateral nasal bar	7.9, 8.5 H	9.1	10.7	13.7 H
Minimum width of dorsal nasal bar	2.5, 2.7, 3.1 H	2.5	2.2	6.2 H

process, USNM 445785; mandibular symphysis with left ramus, BBM-X 151278 (Figs. 15D, 16A); left mandibular ramus lacking the medial process and most of the symphysis, BPBM 158681 (Fig. 15C).

Maui, Puu Naio Cave: maxilla lacking part of the left nasal, USNM 445784.

*Measurements of paratypes*: See Tables 5 and 6.

*Diagnosis*: Similar to *Chloridops kona* but with the bill smaller and shorter, and the dorsal nasal bar broader anteriorly. *Chloridops wahi* and *C. kona* are very similar in other characters of bill osteology, including the lateral cotyla which is elevated and angled posteromedially, the narrow sagittal groove in the lingual surface of the mandibular symphysis, the flattened posterior portion of the tomial

TABLE 6

MEASUREMENTS (MM) OF THE MANDIBLE IN *Chloridops*

	<i>Chloridops</i> sp., Kauai	<i>Chloridops wahi</i> , Oahu	<i>Chloridops</i> sp., Maui	<i>Chloridops kona</i>	<i>Chloridops regiskongi</i>
Total length	27.9	—	21.2	31.1	36.5, 37.3
Length of tomial crest	14.3	14.0	11.0	16.0	17.1, 17.8, 19.9
Symphysis length	9.2	10.0	6.8	12.4	10.9, 11.1, 12.6
Greatest width of symphysis	13.1	—	10.1	14.7	16.5, 17.8, 18.0
Greatest width of mandible	—	—	16.8	23.2	28.8, 29.0
Symphysis height	5.7	6.2	4.5	7.1	8.5, 9.4
Length of lateral cotyla	4.3	—	3.2	4.3	5.6, 5.6, 6.3
Width of articular end with medial process	7.1	—	5.4	—	—
Height at lateral cotyla	3.6	4.1, 4.2	3.0	4.4	4.9, 5.0, 5.2, 6.0
Height at angle of mandible	9.7	8.6, 9.4	6.5	10.9	10.0, 10.9, 11.6
Ramus length (middle part)	12.5	11.7, 12.0	10.0	14.4	14.2, 14.2, 14.4, 14.9

←

FIG. 15. Mandibles of *Chloridops* in dorsal view. A, *C. regiskongi*, new species (USNM 445789); B, *C. kona*, male (AMNH 435677); C, *C. wahi*, new species (BPBM 158681); D, *C. wahi* (BBM-X 151278). Scale = 1 cm.

crest of the mandible, the very blunt, close-set ventral ridges of the maxilla, and the presence of a foramen on each nasal above the narial opening. The mandible of *C. wahi* also resembles those referred to *Chloridops* sp. from Maui and Kauai, except that it has a narrower lingual trough with a deeper sagittal groove in the symphysis, and is larger than the specimen of *Chloridops* sp. from Maui. The bill differs from that of *C. regiskongi*, new species, in having the maxilla less deep, the blunt sagittal crest of the maxilla absent, the dorsal nasal bar much narrower, the narial openings subcircular, the lateral nasal bars more robust, the nasal septum usually partly ossified, the ventral ridges of the maxilla more blunt and close-set, the antorbital space relatively small, the posterior margin of the mandibular symphysis nearly straight, the lateral cotylae of the mandible elevated and angled posteromedially; in the presence of a foramen above each narial opening, and in the presence of a sagittal groove in the mandibular symphysis.

*Remarks:* Although the bill differs in qualitative characters and in size, this species is clearly allied to *C. kona* and to the specimens from Kauai and Maui referred only to *Chloridops* sp. The only skeletal element that is known from all of these forms is the mandible, so that the sagittal groove in the mandibular symphysis is the only synapomorphy yet detected in all of them. This character is more pronounced in *C. kona* and *C. wahi* than in the specimens referred to *Chloridops* sp.

*Chloridops* sp., Maui

*Material:* A complete mandible, the left ramus having been broken and repaired, USNM 445786.

*Distribution:* Maui: Puu Naio Cave.

*Measurements:* See Table 6.

*Remarks:* This almost perfectly preserved mandible is the smallest existing specimen referable to *Chloridops*. The next larger mandible, a paratype of *C. wahi* from Oahu (BBM-X 151278), measures 18% larger in estimated length. The small mandible from Maui agrees with *C. wahi* and *C. kona* in the characters that set these species apart from *C. regiskongi* (see diagnoses of *C. wahi* and *C. regiskongi*), and differs from *C. wahi* and *C. kona* in having the walls of the symphysis more widely spaced. Additional specimens of *Chloridops* are needed from Maui before we can decide whether to interpret this mandible as an extreme of intraspecific variation in *C. wahi* or as a distinct species.

***Chloridops regiskongi*, new species**  
(Figs. 14C, 15A, 16A–B)

“*Psittirostra* (*Chloridops*), giant Oahu species” Olson and James, 1982b:40, 45; 1984: 771; James, 1987:225, 228.

*Holotype:* Maxilla lacking the tip and the right tomial crest, with a small hole anterior to the left narial opening, BPBM 158742 (Figs. 14C, 17A). Collected 14 August 1981 by Aki Sinoto, Patrick C. McCoy and others.

*Type locality:* Site 50-Oa-B6-22, Barbers Point, Oahu, Hawaiian Islands.

*Distribution:* Oahu: Barbers Point and Ulupau Head.

*Etymology:* “Of King Kong” from the Latin genitive of *rex*, king, plus *Kong*;

in reference to the great size of this finch by allusion to the giant primate of cinema fame. In a newspaper article, Olson was once quoted as saying this species was “a giant, gargantuan, a King Kong finch” (Benson 1977), an appellation that would never have occurred to him, this being a typical example of the liberties taken with quotation marks by the print media. Nevertheless, because of its ridiculousness, the name naturally stuck and we found ourselves referring jocularly to this species as the “King Kong finch” ever afterwards.

*Measurements of holotype:* See Table 5.

*Paratypes* (all from Barbers Point): Maxilla with only the ventral surface and tomial crests remaining, BPBM 158814 (Figs. 14C, 17C); nearly intact mandible lacking part of both medial processes, USNM 445789 (Figs. 15B, 17B); mandible lacking part of both rami and medial processes, USNM 445788; mandible lacking the posterior half of the right ramus and left medial process, USNM 445787; mandible lacking part of the symphysis and left ramus, BBM-X 151419; left quadrate, USNM 445790.

*Measurements of paratypes:* See Table 6.

*Diagnosis:* A grosbeak finch possessing the largest bill known among finch-like drepanidines. The bill differs markedly from the other two species of *Chloridops* in shape as well. The maxilla is much deeper and is sharply pointed, the sides of the maxilla rising steeply to form a blunt crest that extends along the dorsal midline from the tip through the dorsal nasal bar. The dorsal nasal bar is extremely broad compared to other drepanidines, so broad as to occlude the anterior part of the narial openings, which are consequently higher than long. The dorsal nasal bar is also distinctively elevated at its posterior margin. *C. regiskongi* differs further from *C. kona* and *C. wahi* as follows: the lateral nasal bars are weaker; the nasal septum is unossified (usually partly ossified in *C. kona* and *C. wahi*); the ventral surface of the maxilla does not extend as far posteriorly, so that there is no ossified floor beneath the narial openings, which, with the extreme depth of the maxilla and the fairly extensive area of co-ossified nasals, creates a greater antorbital space; the prominent ventral ridges of the maxilla are less blunt and less close-set, tending more toward the configuration in *Rhodacanthis*; the foramina above the narial openings are absent; the mandibular symphysis lacks a distinct sagittal groove; in ventral aspect, the posterior margin of the symphysis is curved, as is more typical of finches, rather than nearly straight; and the lateral cotylae lie approximately parallel to each other and are not elevated, as opposed to being elevated and angled posteromedially.

*Remarks:* In addition to the character differences mentioned in the diagnosis, the bill of *C. regiskongi* appears to have developed along a different allometric trajectory from the other species in the genus, as it differs further from *C. kona* and *C. wahi*, but resembles the smallest known mandible of the genus (*Chloridops* sp., Maui) in being less extensively ossified, with the posterior portion of the tomial crest of the mandible not as broad and flat, the middle part of the ramus a little less deep (and consequently the angle of the mandible somewhat less acute), and the surface for attachment of *M. depressor mandibulae* less expanded.

Although we have placed this species in the genus *Chloridops*, its osteological differences from other members of the genus are extensive enough to raise the possibility of parallel evolution in two lineages from weaker-billed finches. In particular, the broad, parallel lateral cotylae of the mandible combined with the

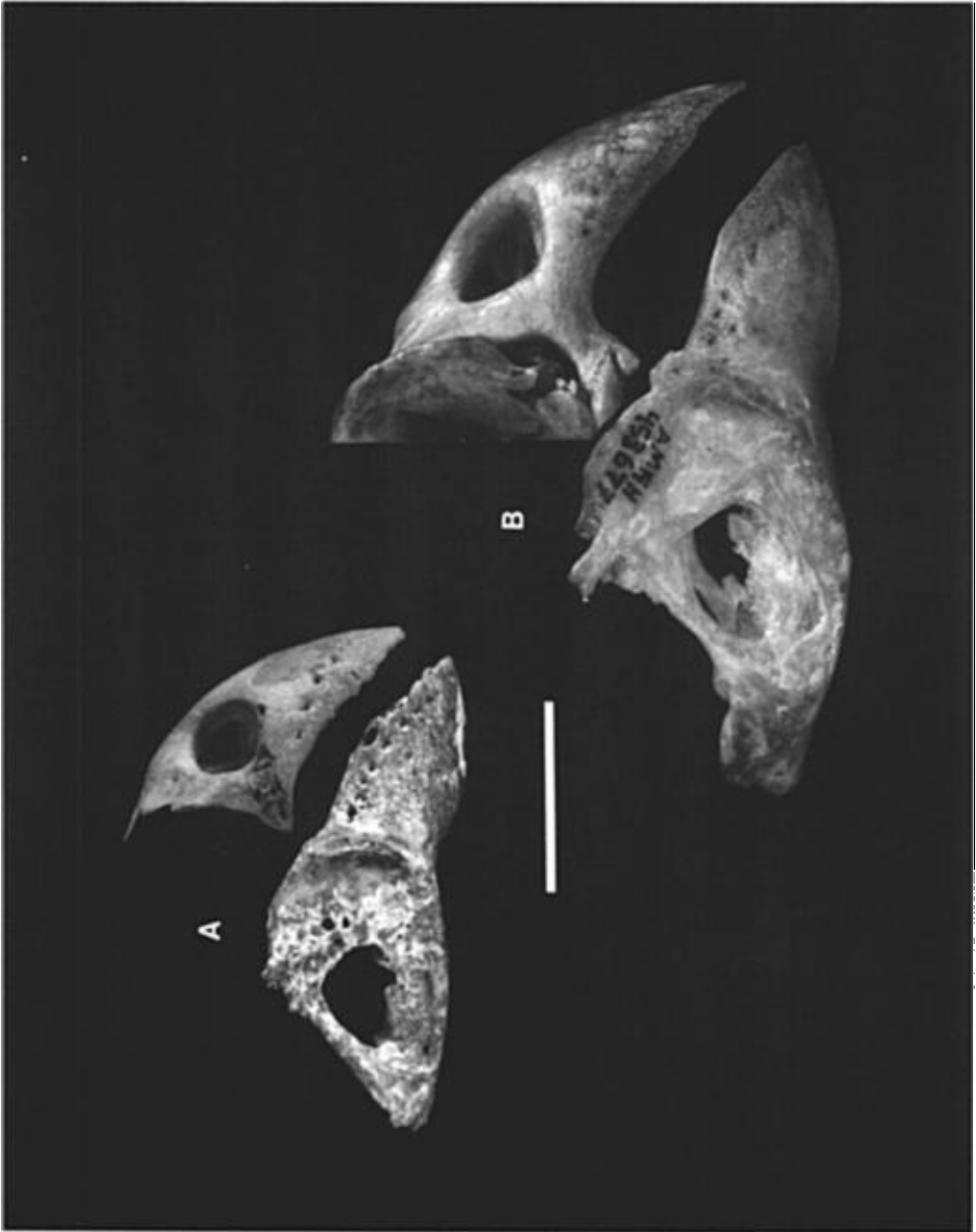

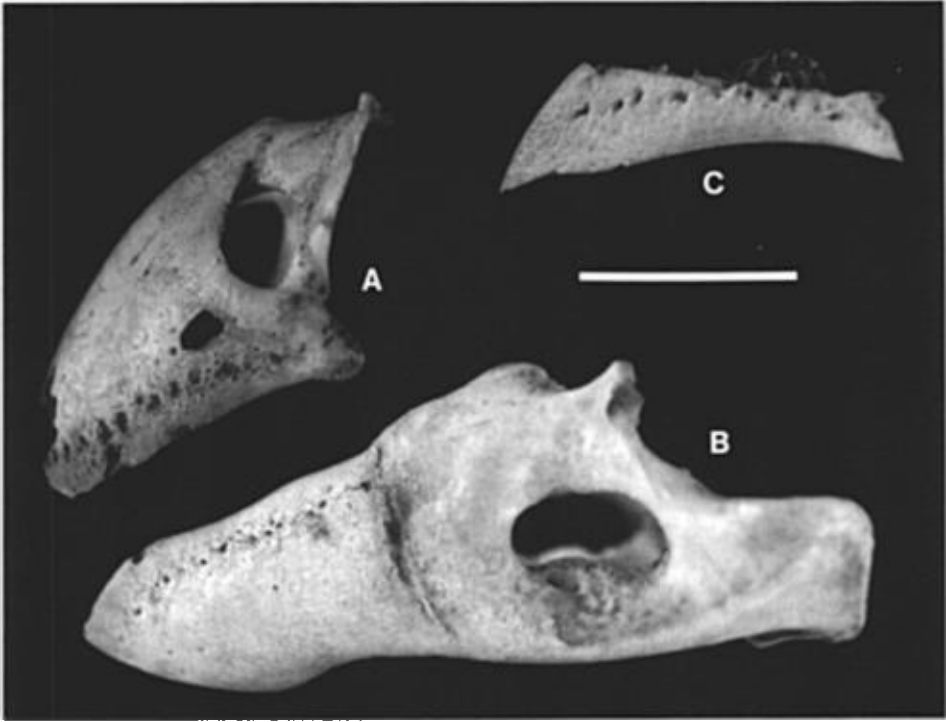

FIG. 17. Maxillae and mandible of *Chloridops regiskongi*, new species, in lateral view. A, maxilla, holotype (BPBM 158742); B, mandible (USNM 445789); C, maxilla lacking the dorsal portion (BPBM 158814). Scale = 1 cm.

prominent ventral ridges and weak lateral nasal bars of the maxilla could be taken as evidence that *C. regiskongi* is a sister taxon of *Rhodacanthis*.

#### Genus Incertae Sedis, Unassigned Maui Finch

"*P[sittirostra]* (*Chloridops*) sp." James et al., 1987:2353.

*Material*: A fragment of cranium including the frontal and parts of the interorbital septum and maxilla, USNM 445791.

*Distribution*: Maui: Puu Naio Cave.

*Measurements (mm)*: Interorbital width of frontal, 9.8; minimum width of dorsal nasal bar, 2.4; height of narial opening, 4.3; length of narial opening, 4.5.

*Remarks*: This provocative fragment preserves just enough morphology to make it clear that it is something new, but not enough to determine its relationships. It represents a finch about the size of *C. wahi*, with a sturdy, arched maxilla. Although we had earlier referred it to *Chloridops*, it differs from *C. kona* and *C. wahi* in having the interorbital septum less thickened, the lateral nasal bars as

←

FIG. 16. Maxillae and mandibles of *Chloridops wahi*, new species, and *C. kona*, in lateral view, oriented approximately as in life. A, *C. wahi* (maxilla = holotype BBM-X 155524, mandible = BBM-X 151278; both images are of the left side printed in reverse); B, *C. kona* male (AMNH 453677). Scale = 1 cm.

well as the jugal and palatine articulations of the mandible weaker, and the lateral troughs shallower. It differs from *C. regiskongi* in having subcircular narial openings and a much smaller antorbital space. It differs from *Rhodacanthis* in having the medial and lateral troughs of the maxilla shallower, from *Orthospiza* in having the narial openings smaller and the tomial crest broader posteriorly, and from *Telespiza* in not having the posteroventral edge of the maxilla distinctly V-shaped.

Little more can be said about this bird until better specimens are found. It is worth mentioning that this fragment is not the only enigmatic bit of finch bill in the USNM collections from Maui. Fossils we have examined strongly suggest that at least two more finch-billed species exclusive of *Telespiza* will eventually be described from Maui, a prospect that should provide some impetus for an intensified fossil search.

#### Genus *Rhodacanthis* Rothschild, 1892

The two extinct finches in this genus, *Rhodacanthis palmeri* (Greater Koa Finch) and *R. flaviceps* (Lesser Koa Finch), were restricted to the island of Hawaii when they were discovered by late 19th-century collectors. As no skeletons were preserved of either species, we removed the bones from one skin specimen each of *R. palmeri* and *R. flaviceps*. These forms had sometimes been considered conspecific, although we found qualitative differences in bill osteology that support Amadon's (1950) view of them as distinct, sympatric species.

Characters diagnosing *Rhodacanthis* are as follows. The ventral trough of the maxilla is deeper than in other finch-billed drepanidines. The ventral ridges are more prominent than in other genera except *Chloridops*, and are sharp, whereas in *Chloridops* they are blunt. As in *Chloridops*, the ventral ridges extend about three-fourths of the distance to the tip of the maxilla, as opposed to nearly reaching the tip as in *Telespiza*, *Loxioides*, and *Orthospiza*, new genus, or being confined posterolaterally as in *Psittirostra* and *Melamprosops*. The narial openings are subcircular, not elongated as in *Psittirostra* and *Melamprosops*, and not greatly enlarged as in *Orthospiza*. The dorsal nasal bar is stouter than in *Orthospiza*, *Melamprosops*, and *Psittirostra* but less so than in *Chloridops*, *Telespiza*, and *Loxioides*. The mandible in *Rhodacanthis* is sturdy and deep compared to *Telespiza*, *Loxioides*, *Psittirostra*, and *Melamprosops*. It is distinctly pointed rather than having a broad tip like *Chloridops* or *Loxioides*. The symphysis is longer than in *Orthospiza* and *Loxioides*. The lateral cotylae of the mandible can be distinguished from other drepanidines, except *Chloridops regiskongi*, through the combination of not being elevated, being very broad in the middle, and being angled slightly in the posterolateral rather than posteromedial direction.

We have recorded fossils of *Rhodacanthis* from Oahu (Olson and James 1982b; James 1987) and Maui (James et al. 1987). These differ from *R. palmeri* and *R. flaviceps*, but not in ways that we consider important enough to justify formally describing new species at this time, considering that our comparative material is limited to only one partial skeleton of each species.

#### *Rhodacanthis* aff. *palmeri* Rothschild, 1892

*P[sittirostra]* (*Rhodacanthis*) aff. *palmeri* James et al., 1987:2353.

*Material*: Maxilla with the dorsal part missing from the posterior half, USNM 445792.

TABLE 7  
MEASUREMENTS (MM) OF THE MAXILLA IN *Rhodacanthis* AND *Orthospiza*.  
H = HOLOTYPE

	<i>Rhodacanthis palmeri</i>	<i>Rhodacanthis</i> aff. <i>palmeri</i>	<i>Rhodacanthis flaviceps</i>	<i>Rhodacanthis</i> aff. <i>flaviceps</i>	<i>Orthospiza howarthi</i>
Dorsal length	20.5	—	17.7	17.3	15.3 H*, 17.4
Ventral length	13.8	—	10.9	11.0, 11.1, 11.2	9.7 H*, 11.7
Length from lateral corner of nasofrontal hinge	20.4	—	17.7	17.8	16.0 H*, 17.5
Length from jugal articulation	15.5	15.7	13.4	13.0, 13.1, 13.5	11.9 H*, 12.4
Length from anterior narial opening	12.3	—	9.8	10.2, 9.7, 9.6	6.5 H*, 9.3
Width of nasofrontal hinge	11.7	—	10.6	11.5	9.3, 9.4 H
Length of narial opening	4.5	—	4.5	4.5, 4.7, 5.2	5.4, 5.9 H
Height of narial opening	4.6	—	3.5	4.0, 4.0, 4.1	4.8 H, 4.9
Height through lateral nasal bar	8.6	—	8.3	8.4	8.4 H, 9.2
Minimum width of dorsal nasal bar	2.0	—	1.7	1.7, 1.8, 1.6	1.4, 1.6 H

\* Approximately 2 mm should be added to these measurements to compensate for the broken tip of the maxilla in the holotype of *O. howarthi*.

*Distribution*: Maui: Puu Naio Cave. (*R. palmeri* is known historically from the island of Hawaii.)

*Measurements*: See Tables 7 and 8.

*Remarks*: This maxilla differs from *R. flaviceps* and agrees with *R. palmeri* in being larger and having a deeper, wider ventral trough of the maxilla. The trough is even deeper but narrower than in the comparative specimen of *R. palmeri*, yet it may fall within the range of variation for that species.

*Rhodacanthis* aff. *flaviceps* Rothschild, 1892

"*Psittirostra (Rhodacanthis) flaviceps*" Olson and James, 1982b:39, 45.

"*Psittirostra (Rhodacanthis) sp.*" James, 1987:225, 228.

"*P[sittirostra] (Rhodacanthis) aff. flaviceps*" James et al., 1987:2353.

TABLE 8  
MEASUREMENTS (MM) OF THE MANDIBLE IN *Rhodacanthis* AND *Orthospiza*.  
H = HOLOTYPE

	<i>Rhodacanthis palmeri</i>	<i>Rhodacanthis flaviceps</i>	<i>Rhodacanthis</i> aff. <i>flaviceps</i>	<i>Orthospiza howarthi</i>
Total length	30.0	26.1	26.3	26.6
Length of tomial crest	16.5	12.9	13.0, 13.7	12.4
Symphysis length	10.3	8.7	7.4, 7.9	7.1
Greatest width of symphysis	12.4	11.4	11.4, 11.6	11.1
Greatest width of mandible	20.1	18.8	—	19.3
Symphysis height	6.0	5.7	4.6, 4.8	6.1
Width of articular end with medial process	6.0	—	5.4	6.4, 6.9 H
Height at lateral cotyla	2.8	3.1	2.8	2.5, 2.7 H
Height at angle of mandible	6.2	6.2	5.8	5.9, 7.8 H
Ramus length (middle part)	12.5	11.0	11.1	12.6, 13.4 H



*Material:* Puu Naio Cave, Maui: Maxilla lacking left nasal bar, USNM 445794; mandible lacking posterior third of left ramus, USNM 445793; mandibular symphysis, USNM 445796.

Barbers Point, Oahu: Maxilla, BPBM 158861.

Ulupau Head, Oahu: Maxilla lacking parts of the fused nasals, USNM 445795.

*Distribution:* Oahu: Barbers Point and Ulupau Head. Maui: Puu Naio Cave. (*R. flaviceps* is known historically from the island of Hawaii.)

*Measurements:* See Tables 7 and 8.

*Remarks:* These specimens are similar in size to *R. flaviceps* but differ in having a larger narial opening, a deeper medial trough on the ventral surface of the maxilla, and a decurved rather than straight anterior portion of the tomial crest of the mandible. In the last two characters, the fossils agree more with the larger *R. palmeri* than with *R. flaviceps*. Faced with such an ambiguous combination of characters, we are unable to suggest whether this form is a distinct species, is conspecific with *R. flaviceps*, or is conspecific with *R. palmeri*.

### **Orthiospiza, new genus**

*Type species:* *Orthiospiza howarthi*, new species.

*Included species:* Type-species only.

*Distribution:* Maui: higher elevations on the south and east slopes of Mt. Haleakala.

*Etymology:* Greek, *orthios*, high, lofty, and *spiza*, a finch, to emphasize that specimens of this genus have so far been found only at relatively high elevations. The gender is feminine.

*Diagnosis:* Large drepanidines with arched, finch-like bills, distinguished by the greatly enlarged narial openings, the absence of a ventral trough on the maxilla, and the straight rather than indented posteroventral contour of the maxilla. The cranial fenestra is smaller than in any other finch-billed drepanidine in which the cranium is known, except *Chloridops kona*. The muscle scars on the cranium and mandible reflect a well-developed musculature for adduction of the mandible, with robust zygomatic processes, prominent interorbital cristae, a distinct crest delimiting the main area of attachment of adductor muscles on the skull, and partly ossified aponeuroses preserved on the coronoid processes and on the ventral margins of the mandibular foramina in the adult specimen. By contrast, the palatines are underdeveloped, with the transpalatine processes short and weak and the prepalatine bars very weak compared to *Rhodacanthis* and other large finches. The prepalatine bars also differ from the relatively thin bars of *Psittirostra* in being very short rather than elongated. The surfaces on the maxilla for articulation of the palatines and jugals are distinctly weaker than expected for a finch with such a sturdy bill.

The maxilla is broad and pointed, with an arched dorsal surface. The tomial crest of the maxilla is evenly decurved, as in *Telespiza*, and the dorsal nasal bar is elongated, as in *Psittirostra*. Broad, moderately excavated lateral grooves provide the only relief on the otherwise nearly flat ventral surface of the maxilla. The ventral ridges are very close-set, as in *Chloridops kona*, but extend nearly to the tip of the maxilla, as in *Telespiza* and *Loxioides*. The ventral ridges differ from other genera in being not at all prominent, and in being rugose in the adult.

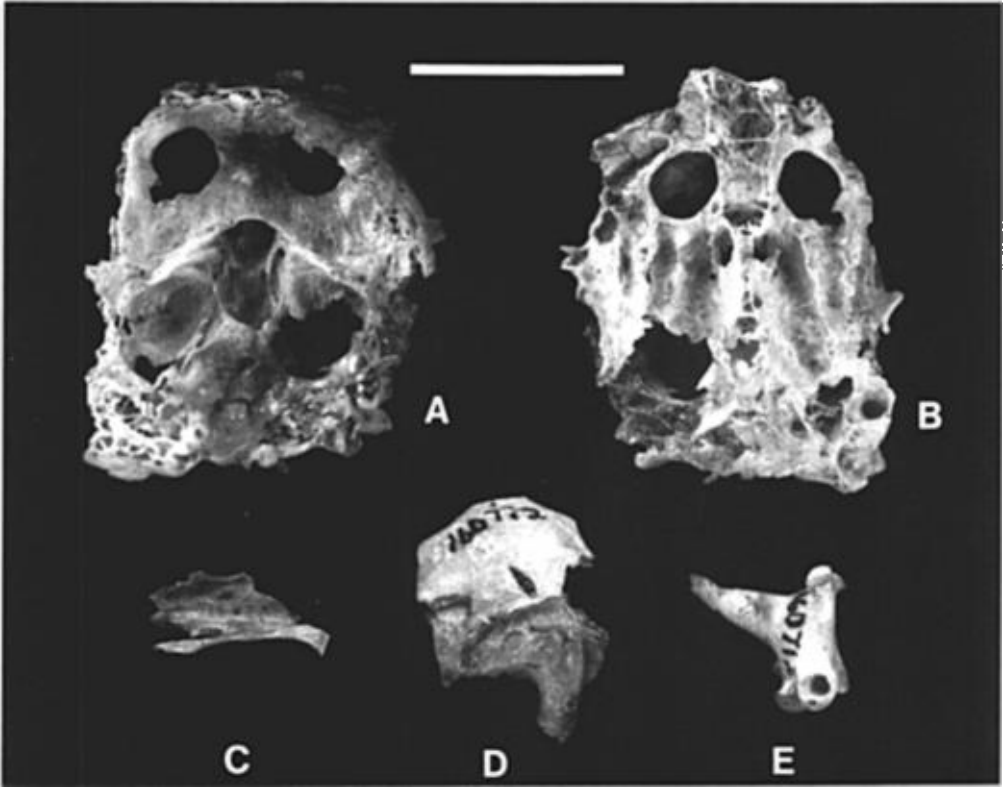

FIG. 18. The cranium, palatine, and quadrate of the holotype of *Orthospiza howarthi*, new genus and species (BPBM 160712). *A*, posterior view of the interior of the brain case; *B*, the same fragment in anterior view, showing the prominent interorbital cristae, the relatively small cranial fenestrae, and trabeculae along the midline indicating where the interorbital septum is broken away; *C*, part of the fused palatines with the right prepalatine bar and transpalatine process; *D*, fragment of the braincase with the zygomatic process; *E*, left quadrate. Scale = 1 cm.

Between these ridges, where the medial trough usually occurs, the maxilla is flat and is also rugose in the adult.

The mandible is deep and pointed as in *Rhodacanthis*, but has a short symphysis and a strongly and evenly decurved tomial crest as in *Loxioides*. The shape of the lateral cotylae, which are elevated, angled posteromedially, and have the anterior portion not much wider than the posterior portion, is reminiscent of the much smaller cotylae of *Xestospiza fastigialis*, new genus and species.

***Orthospiza howarthi*, new species**  
(Figs. 18, 19D–G, 20A–B, D–E, 21)

*Holotype*: Partial associated skeleton, BPBM 160712. Collected between 24 February and 4 March 1984 by Francis G. Howarth, Fred D. Stone, Betsy H. Gagné and others. The specimen consists of the maxilla lacking the tip (Fig. 19D, F, G), fragments of the cranium preserving the posterior wall of the orbits (Fig. 18A, B), the basitemporal plate, the left zygomatic process (Fig. 18D), and the supraoccipital, the right pterygoid, the fused palatines with the left side mostly

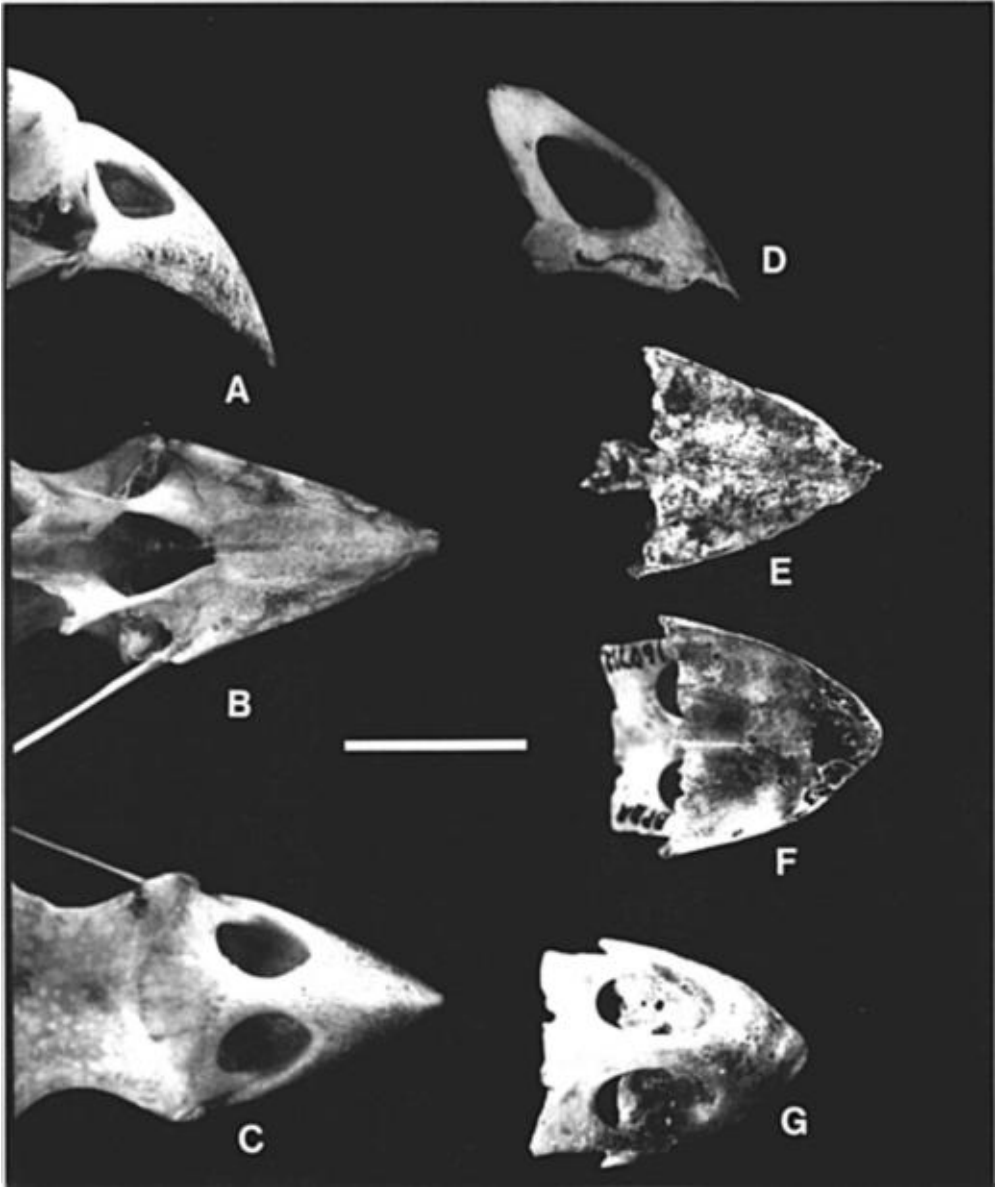

FIG. 19. Maxillae of *Rhodacanthis flaviceps* and *Orthospiza howarthi*, new genus and species. *A*, lateral, *B*, ventral, *C*, dorsal views of *R. flaviceps* female (AMNH 453644); *D*, lateral, *F*, ventral, *G*, dorsal views of *O. howarthi* holotype (BPBM 160712; lateral view is of the left side printed in reverse); *E*, ventral view of *O. howarthi*, immature (USNM 370557). Scale = 1 cm.

missing (Fig. 18C), both quadrates (Fig. 18E), both rami of the mandible but not the symphysis (Fig. 20B, D), the axis and eight additional cervical vertebrae, three thoracic vertebrae, two caudal vertebrae, the pelvis (Fig. 21A), the anterior half of the right scapula, the dorsal half of the right coracoid, the ventral third of the left coracoid, both humeri (each missing parts of both ends; Fig. 21B), the right ulna (Fig. 21C), fragments of the shaft of the left ulna, both carpometacarpi with

damaged proximal ends (Fig. 21D), both femora with damaged distal ends, the right tibiotarsus with damaged ends, the broken left tibiotarsus, proximal ends with parts of the shafts of both tarsometatarsi, the damaged distal end of the left tarsometatarsus, three pedal phalanges, and some unidentified bone fragments.

*Type locality:* Lua Manu (1,830 m), Kipahulu Valley, Maui, Hawaiian Islands. The location of the holotype within the cave corresponds with "Site L" on the cave map drawn by Fred Stone and Francis Howarth, a copy of which is on file with the accession record at the Bishop Museum (BPBM Accession 1984.116).

*Distribution:* Maui: Lua Manu, Puu Makua Cave, and Auwahi Cave.

*Etymology:* To Francis G. Howarth, for his studies of the entomology of Hawaiian caves and for his attentiveness to potential fossil deposits in lava tubes.

*Measurements (mm) of holotype:* The comparable measurement of *Rhodacanthis palmeri* (AMNH 453623) is given in parentheses when available. Humerus: length (estimated), 25.0 (24.5); proximal width, 7.2 (7.8); mid-shaft width, 2.4 (2.4). Ulna: length, 29.8. Carpometacarpus: length, 16.2. Synsacrum: length, 2.5. Pelvis: width between antitrochanters, 19.1. Femur: length, 26.9; proximal width, 4.8; mid-shaft depth, 1.9. Tibiotarsus: length without cnemial crest, 41.5. Tarsometatarsus: proximal width, 4.3 (4.2); mid-shaft width, 1.7 (1.7). For additional measurements of holotype, see Tables 7 and 8.

*Paratypes:* Auwahi Cave: Maxilla lacking lateral nasal bars, USNM 370557 (Fig. 19E); complete mandible, USNM 372839 (Fig. 20A, E); humerus lacking the head and distal condyles, USNM 372840. These bones appear to be from a single juvenile individual.

Puu Makua Cave: Complete maxilla, not fully mature, USNM 445797; mandible in two pieces, lacking the anterior two-thirds of the right ramus, not fully mature, USNM 445798. These bones may be from a single individual.

*Measurements of paratypes:* See Tables 7 and 8.

*Diagnosis:* As for the genus.

*Remarks:* The body size is comparable to *Rhodacanthis palmeri*, the largest of the finch-billed drepanidines for which post-cranial bones are available to compare.

The relative completeness of the holotype of *O. howarthi* permits us to make some additional osteological comparisons beyond those mentioned in the generic diagnosis. The fragments of cranium preserve evidence of the drepanidine affinities of *Orthospiza*: the interorbital septum has widely separated walls enclosing a network of bony trabeculae; the posterolateral margin of the cranial fenestra is straight; the anterior wall of the cranial cavity between the cranial fenestrae is broad and flat, not blade-like. Together these conditions define a synapomorphic character that occurs only in the Carduelinae, including the Drepanidini (Zusi 1978). The palatine process of the premaxilla is fused to the prepalatine bar in the configuration of a lateral flange, another derived character that is present in cardueline finches, but also appears in other, unrelated passerines (Bock 1960).

*Orthospiza* has many presumably primitive characters in common with the other finch-billed drepanidine genera. The palatines have a very broad blade, short transpalatine processes and prepalatine bars, and have the walls of the palatine hasp wide-set to embrace the thick basisphenoid rostrum. The quadrate has the typical stocky form found in finch-billed drepanidines, with a thick body and a rounded medial condyle set on a short neck. The large narial opening in

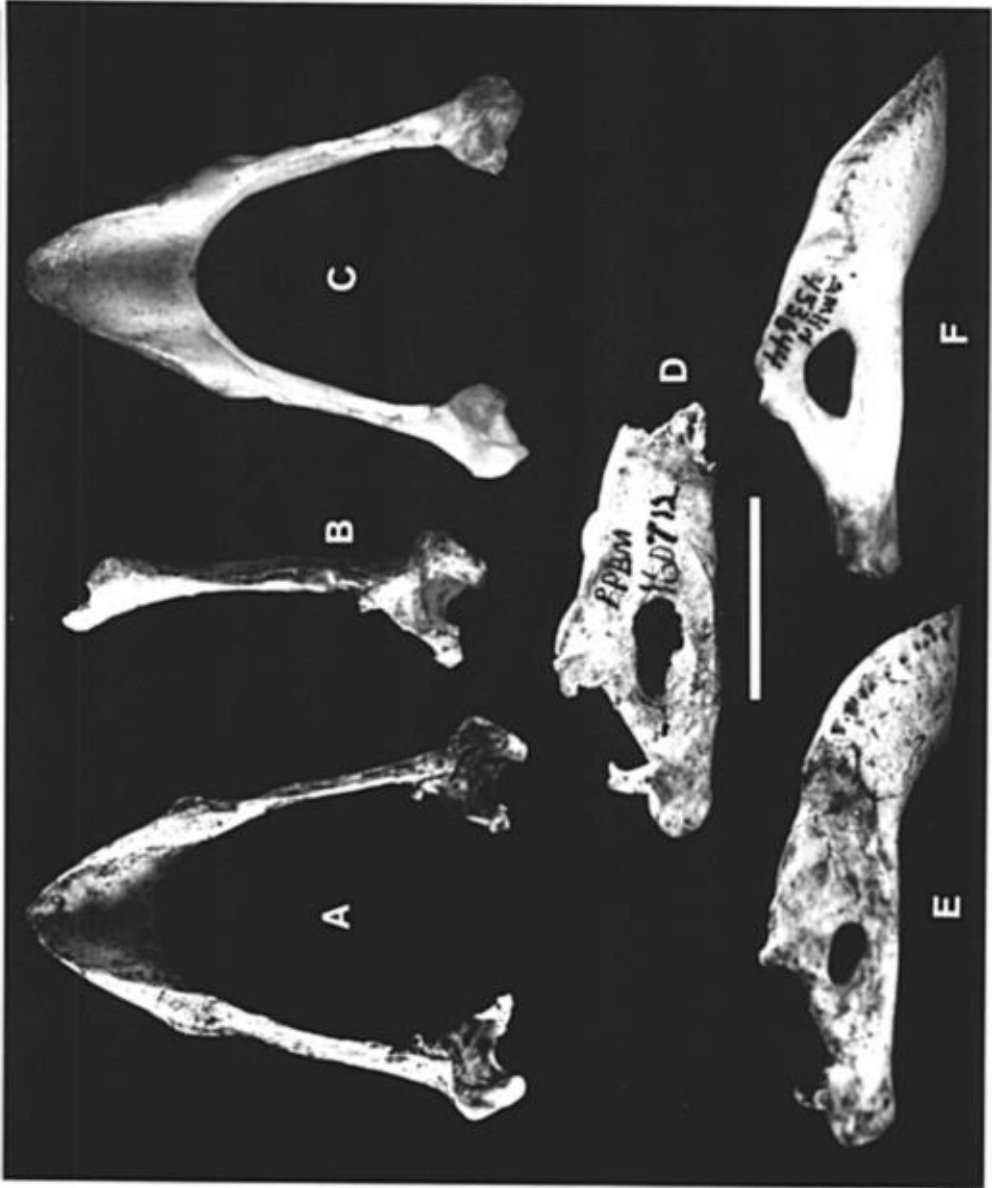



FIG. 21. Selected postcranial bones of the holotype of *Orthospiza howarthi*, new genus and species (BPBM 160712). A, pelvis in dorsal view; B, left humerus in anconal view; C, right ulna in ventral view; D, right carpometacarpus in ventral view. Scale = 1 cm.

*Orthospiza* retains the subcircular shape that is typical of heavy-billed finches, rather than being elongated anteroposteriorly as is true of the relatively weak-billed *Psittirostra* and *Melamprosops*, and of all thin-billed drepanidines except *Hemignathus wilsoni* and *H. lucidus*. The broad pelvis is also characteristic of the finch-billed as opposed to the thin-billed drepanidines.

Autapomorphic characters that distinguish *Orthospiza* from other drepanidines are the greatly enlarged but not elongated narial openings, the absence of a medial trough on the maxilla, and the straight posteroventral edge of the maxilla. *Orthospiza* shares at least one character with each of several other finch-billed genera, although none of these stands out as convincing evidence of relationship: the reduced size of the cranial fenestra is shared with *Chloridops*, the weak lateral nasal bars and pointed bill are shared with *Rhodacanthis*, and the weak ventral ridges that extend nearly to the tip of the maxilla resemble *Loxioides* and *Telespiza*.

Two of the three known specimens of *Orthospiza* are juveniles. These were not found in owl pellet deposits but appear to be remains of birds that entered

←  
FIG. 20. Mandibles of *Orthospiza howarthi*, new genus and species, and *Rhodacanthis flaviceps*. A, dorsal, E, lateral views of *O. howarthi*, immature (USNM 372839); B, dorsal, D, lateral views of *O. howarthi*, holotype (BPBM 160712); C, dorsal, F, lateral views of *R. flaviceps*, female (AMNH 453644). Scale = 1 cm.

the caves unaided. A high proportion of juveniles dying in caves might be a reflection of species-specific behaviors such as cavity nesting or exploratory foraging by young birds.

*Orthospiza* is one of relatively few avian fossil taxa that may have been restricted to montane habitats in the Hawaiian Islands. All of the specimens originate from three lava tubes located at relatively high elevations (1,145, 1,463, and 1,830 m). No specimens have yet been found in Puu Naio Cave (305 m), the most productive site for fossil passerines on Maui so far.

It is a striking circumstance that the only two passerine skeletons preserved in the Upper Kipahulu Valley caves are of an extinct thrush and *O. howarthi*, while the abundant native species that occur in the vicinity now are not represented in the cave.

### **Xestospiza**, new genus

*Type species: Xestospiza fastigialis*, new species.

*Included species: Xestospiza fastigialis*, new species, *Xestospiza conica*, new species.

*Distribution:* Kauai, Oahu, Molokai, and Maui.

*Etymology:* Greek, *xestos*, planed, scraped, plus *spiza*, a finch; from the shape of the maxilla, which gives the appearance of having been planed to a straight profile, and in one species has a distinctly flattened dorsal surface. The gender is feminine.

*Diagnosis:* Members of this genus are set apart from the other finch-billed drepanidines by their cone-shaped rather than arched bills. The dorsal profile of the maxilla is straight or nearly straight as opposed to distinctly curved as in all other finch-billed drepanidines. The bill is relatively long and narrow and the narial openings are slightly elongated anteroposteriorly compared to the drepanidine finches with heavier, arched bills (*Telespiza*, *Rhodacanthis*, *Chloridops*, and *Orthospiza*).

This genus most closely resembles *Melamprosops*, but differs in having a sturdier dorsal nasal bar, the maxilla deeper below the narial openings, a shallower medial groove and more pronounced ventral ridges, and a less deeply V-shaped posteroventral contour of the maxilla, in addition to having a conical bill.

*Remarks:* Because one of the new species included in *Xestospiza* is known only from a pair of maxillae, we have limited the generic diagnosis to characters of that element.

The conical rather than arched bill of this finch-like genus stretches the morphological breadth of the drepanidine radiation in a new direction. Finches with conical bills were widespread in the prehuman avifauna of the archipelago, as they occur on every island with a significant passerine fossil record.

Although not necessarily each other's closest relatives, *Xestospiza*, *Melamprosops*, and *Psittirostra* represent a similar grade of evolution within the drepanidine radiation in that each combines a finch-like bill shape with a few characters that are derived relative to the other finch-billed taxa. The morphological distance between *Xestospiza* and *Melamprosops* is not great, so that we were at first inclined to include the new species in the latter, to avoid introducing a new genus. We reconsidered when it proved that the only characters shared by the three species are ones that we would interpret as primitive.

TABLE 9  
MEASUREMENTS (MM) OF THE MAXILLA IN *Xestospiza*, *Melamprosops* AND  
*Psittirostra*. H = HOLOTYPE

	<i>Xestospiza conica</i>	<i>Xestospiza fastigialis</i>	<i>Melamprosops phaeosoma</i>	<i>Psittirostra psittacea</i>
Dorsal length	16.9 H, 17.4	12.9 + H, 13.8, 14.6	15.1	16.4
Ventral length	10.5 H, 11.2	8.3, 8.4, 8.7	8.1	8.0
Length from lateral corner of nasofrontal hinge	16.0 H	13.3, 14.7, 14.7	14.9	16.2
Length from jugal articulation	12.9 H, 14.5	10.4, 10.7 H, 11.1, 11.9	11.0	12.3
Length from anterior narial opening	9.7 H, 9.9	7.4 H, 7.5, 7.9, 8.1	7.8	7.9
Maximum width	7.6 H	6.9, 7.2 H, 7.6, 7.7	7.2, 8.0	7.7, 8.1
Width of nasofrontal hinge	—	6.1 H, 6.8, 7.2	6.3, 7.0	8.2, 8.6
Length of narial opening	4.4 H	4.0, 4.1, 4.2 H, 4.3	4.3, 4.9	5.2, 5.3
Height of narial opening	3.5 H	2.9 H, 2.9, 3.1, 3.2	3.1, 3.3	3.6, 3.8
Height through lateral nasal bar	6.4 H	6.0 H, 6.1, 6.5	6.9, 7.6	7.4, 8.2
Minimum width of dorsal nasal bar	1.6 H, 1.8	1.3, 1.4, 1.4	1.1, 1.1	1.4, 1.6

*Xestospiza conica*, new species

(Fig. 22G–J)

“cf. *Psittirostra*, cone-billed finch” Olson and James, 1982b:40.

“*Psittirostra* (subgenus incertae sedis), Cone-billed finch” Olson and James, 1982b:45; 1984:771.

*Holotype*: Maxilla lacking the right lateral nasal bar, with a number of small holes worn through the premaxillary, USNM 254881 (Fig. 22G–I). Collected 15 August 1976 by Storrs L. Olson and Robin Rice.

*Type locality*: Site K-3, Makewehi dunes, Kauai, Hawaiian Islands.

*Distribution*: Kauai: known only from the type locality.

*Measurements of holotype*: See Table 9.

*Etymology*: Latinized from Greek, *konikos*, conelike; from the shape of the maxilla.

*Paratype*: Maxilla lacking lateral nasal bars, with the dorsal nasal bar broken and repaired, USNM 254951 (Fig. 22J).

*Measurements of paratype*: See Table 9.

*Diagnosis*: The elongated maxilla of this finch is identified with *Xestospiza* by its nearly straight dorsal profile. It differs from that of *X. fastigialis* in having shorter ventral ridges and a much deeper medial trough on the ventral surface. It also lacks the flattened dorsosagittal surface and the rugose ridges on the dorsal nasal bar that distinguish *X. fastigialis*. The specimens of *X. conica* are larger than maxillae of *X. fastigialis* (Table 9).

*Remarks*: The holotype and paratype are the only specimens yet identified of *X. conica*. Our assignment of this species to the genus *Xestospiza* is tentative pending the discovery of a mandible. The owl pellet remains from Kauai also include two articular ends of mandibles representing two different species of finch-billed birds, one of which may well be *X. conica*, but the material is too fragmentary to determine which.



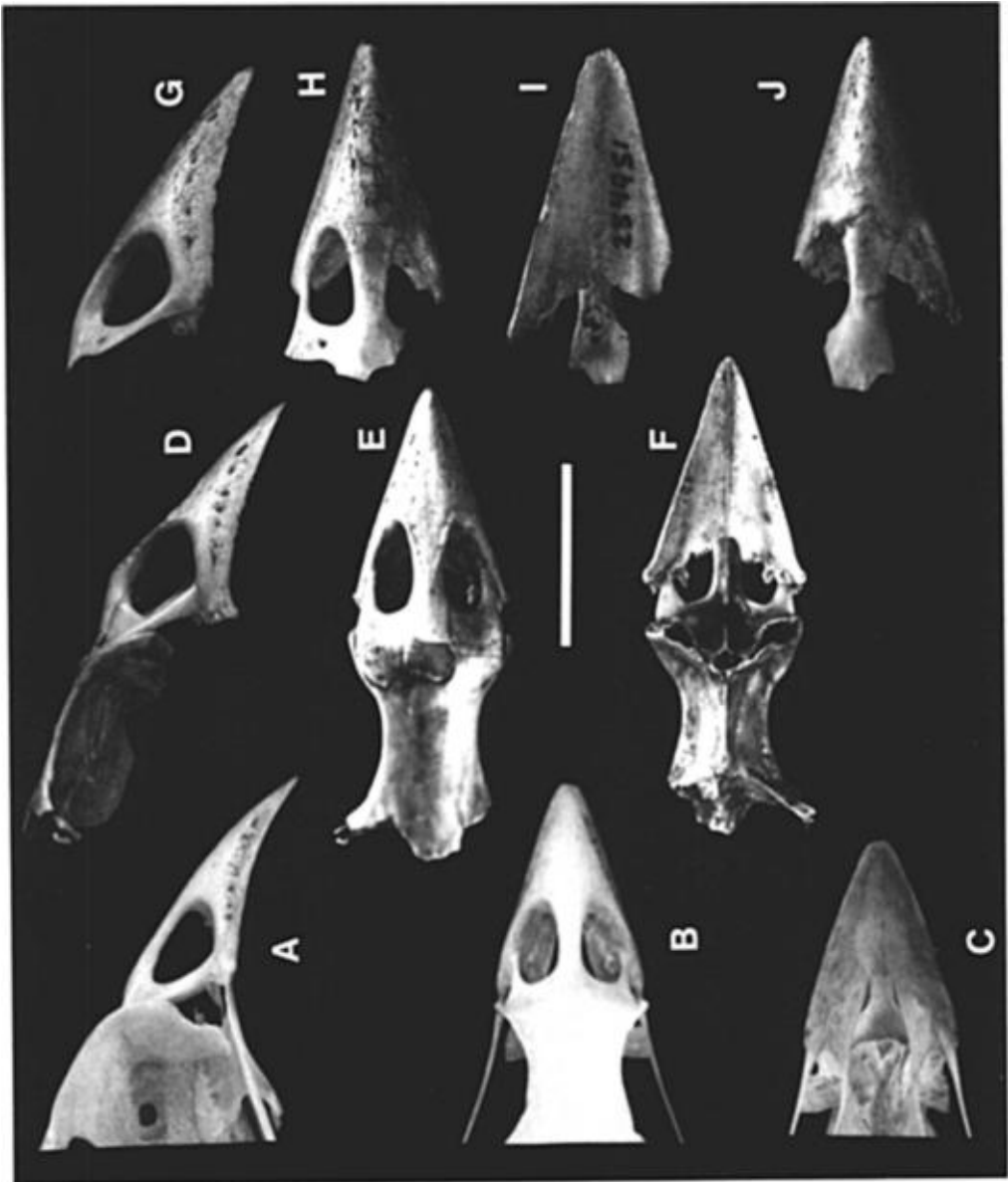

***Xestospiza fastigialis*, new species**  
(Figs. 22D–F, 23B, C, E, F, 24)

“cf. *Psittirostra*, ridge-billed finch” Olson and James, 1982b:40.

“*Psittirostra* (subgenus *incertae sedis*) Ridge-billed finch” Olson and James, 1982b:45; 1984:771.

“Ridge-billed Finch” James, 1987:225.

**Holotype:** Incomplete skeleton, USNM 445821. Collected 4 April 1988 by Storrs L. Olson, Pauline Fiene-Severns, R. Michael Severns, and Thomas W. Stafford, Jr. The specimen consists of the maxilla (Fig. 24D–F), the mandible lacking a portion of the left ramus (Fig. 24A, C), a substantial fragment of the cranium (Fig. 24B), a fragment of the sternum preserving the manubrial spine and coracoidal sulci, part of the synsacrum, ten vertebrae, the dorsal half of both coracoids, the sternal end of the left coracoid, the anterior half of the right scapula, the left scapula, the distal half of the right humerus, the left humerus (Fig. 24G), both ulnae (Fig. 24H), the proximal end of the right carpometacarpus, the left carpometacarpus (Fig. 24I), the left femur (Fig. 24J), the right tibiotarsus (Fig. 24K), the proximal end of the left tibiotarsus, the right tarsometatarsus (Fig. 24L), and a piece of the shaft of the left tarsometatarsus.

**Type locality:** Crystal Cave (183 m), Manawainui Gulch, Maui, Hawaiian Islands.

**Distribution:** Oahu: Barbers Point and Ulupau Head. Molokai: Moomomi dunes and Ilio Point. Maui: Puu Naio Cave, Lua Lepo, and Crystal Cave.

**Etymology:** An adjective based on Latin, *fastigium*, a slope up or down to a point, a gable; from the shape formed by the converging ridges that ascend along the dorsal nasal bar in this species.

**Measurements (mm) of holotype:** Length measurements, with the comparable measurement from *Telespiza ultima* (female, MVZ 124729) in parentheses: basitemporal plate plus the occipital condyle, 4.8 (4.9); humerus, 17.4 (16.4); ulna, 17.5 (19.3); carpometacarpus, 9.9 (11.3); femur, 17.7 (16.9); tibiotarsus without the cnemial crest, 29.0 (28.8); tarsometatarsus, 21.3 (21.7). For additional measurements of holotype, see Tables 9 and 10.

**Paratypes:** Oahu, Barbers Point: complete maxilla, USNM 322483; three slightly damaged mandibles, USNM 445799 (Fig. 23B, E), BBM-X 155522, and BBM-X 155728.

Molokai, Ilio Point: Complete maxilla, BBM-X 178142.

Maui, Crystal Cave, Manawainui Gulch: Partial skeleton, USNM 394085, consisting of the mandible lacking the posterior part of the left ramus (Fig. 23C, F), the basitemporal plate, a fragment of the sternum, the synsacrum, partial right coracoid, partial left scapula, distal end of left ulna, left carpometacarpus, two pelvic fragments including the acetabula, both femora and tibiotarsi, all somewhat damaged, and the left tarsometatarsus lacking the proximal end. Puu Naio Cave:

---

←

FIG. 22. Maxillae of *Melamprosops* and *Xestospiza*, new genus. *A*, lateral, *B*, dorsal and *C*, ventral views of *Melamprosops phaeosoma* (ANMH 810456); *D*, lateral, *E*, dorsal and *F*, ventral views of *X. fastigialis*, new species (USNM 445800; lateral view is of the left side printed in reverse); *G*, lateral, *H*, dorsal and, *I*, ventral views of *X. conica*, new species, holotype (USNM 254881; lateral view is of the left side printed in reverse); *J*, dorsal view of *X. conica* (USNM 254951). Scale = 1 cm.



FIG. 23. Mandibles of *Melamprosops* and *Xestospiza*, new genus. A, lateral view of *M. phaeosoma*, a fossil specimen (USNM 384745); B, lateral and E, dorsal views of *X. fastigialis*, new species (USNM 445799); C, lateral and F, dorsal views of *X. fastigialis*, new species (USNM 394085); D, dorsal view of *M. phaeosoma* (AMNH 810456). Scale = 1 cm.

TABLE 10  
MEASUREMENTS (MM) OF THE MANDIBLE IN *Xestospiza*, *Melamprosops* AND  
*Psittirostra*

	<i>Xestospiza fastigialis</i>	<i>Melamprosops phaeosoma</i>	<i>Psittirostra psittacea</i>
Total length	20.8 + H, 21.2, 21.6, 22.8	23.3, 24.1	23.8, 24.0
Length of tomial crest	10.6, 11.1, 11.8	10.8, 11.0	8.7, 9.1
Symphysis length	6.8 H, 7.6, 7.7, 8.4	7.1	5.2, 5.9
Greatest width of symphysis	6.7, 6.8, 6.9, 7.1 H	7.5	7.4, 7.8
Greatest width of mandible	13.5	15.8	14.6, 14.8
Symphysis height	2.5, 2.8 H, 2.8, 2.8	2.8	3.1, 3.6
Length of lateral cotyla	2.1, 2.2, 2.2	2.6, 3.0	2.9, 3.1
Width of articular end with medial process	3.7, 3.9	3.8, 4.7	4.2, 4.4
Height at lateral cotyla	1.5, 1.5, 1.6 H, 1.6	1.5, 2.1	1.8, 1.9
Height at angle of mandible	3.7, 3.8 H, 3.8, 3.9	3.4, 4.0	4.6, 4.7
Ramus length (middle part)	9.2 H, 9.2, 9.4, 9.9	11.4, 12.0	12.8, 13.4

complete maxilla with the frontal attached, USNM 445800 (Fig. 22D–F); slightly damaged mandible, USNM 445805; right quadrate lacking part of the orbital process, USNM 445801; left quadrate, USNM 445802.

*Measurements (mm) of paratypes:* Associated skeleton, USNM 394085: Cranium: length of basitemporal plate plus the occipital condyle, 4.8. Mandible: length, 21.1 (about 1.6 mm missing from the tip); height of symphysis, 2.9; width of articular end with medial process, 3.9; height at lateral cotyla, 1.8; height at the angle of the mandible, 4.0; length of ramus (middle part), 9.4. Carpometacarpus: length, 9.7. Synsacrum: ventral length, 13.5. Femur: length, 17.4. Tibiotarsus: length without cnemial crest, 28.8. Tarsometatarsus: estimated length, 20.2. For additional measurements of paratypes, see Tables 9 and 10.

*Diagnosis:* A finch with a cone-shaped bill, distinguished from other drepanidines by the two converging, rugose ridges that ascend along the dorsal nasal bar of the maxilla. Between these ridges, the dorsal surface of the nasal bar is flat in cross-section, whereas this surface has a convex cross-section in other drepanidines except the long, thin-billed *Aidemia lutetiae*, new genus and species. The ventral surface of the maxilla has a shallow medial trough and ventral ridges that are moderately developed posteriorly but become indistinct about three-quarters of the distance to the tip of the bill. This is in contrast to *X. conica*, which has a distinctly deeper medial trough and shorter ventral ridges.

The mandible lacks retroarticular processes and in this and other respects is typically finch-like, with a thick-walled symphysis and a deep ramus, particularly at the angle of the mandible. However, the symphysis is relatively long and narrow and the articular end of the mandible is relatively small compared to other finch-billed drepanidines. The small lateral cotylae are slightly elevated and angled posteromedially. The middle part of the ramus is relatively short compared to *Loxioides*, *Psittirostra*, and *Melamprosops*, and in this respect is closer to the condition in the heavier-billed finches.

The quadrate has the form typical of finch-billed drepanidines, with a stout body and a rounded medial condyle.

In the holotype, the walls of the interorbital septum are fused to form a single



FIG. 24. Selected elements of the holotype of *Xestospiza fastigialis*, new genus and species (USNM 445821). *A*, dorsal view of mandible; *B*, ventral view of basicranium; *C*, lateral view of mandible; *D*, lateral, *E*, ventral and *F*, dorsal views of the maxilla; *G*, left humerus in anconal view; *H*, left ulna in ventral view; *I*, left carpometacarpus in ventral view; *J*, left femur in posterior view; *K*, right tibiotarsus in anterior view; *L*, right tarsometatarsus in posterior view. Scale = 1 cm.

sheet of bone, as opposed to being entirely separated by an intervening network of trabeculae as they are in finch-billed drepanidines with heavier beaks such as the similar-sized *T. ultima*. The septum is thus relatively weak and may even have been fenestrated in the missing anterior portion, as it sometimes is in

*Melamprosops phaeosoma*, a bird with similar development of the interorbital septum.

*Remarks:* The body size is in the range of *Telespiza ultima*, although the distal wing elements may be somewhat reduced by comparison (see measurements of holotype).

In general bill shape, *X. fastigialis* has an icterid-like aspect that is particularly reminiscent of cowbirds (*Molothrus*). *X. fastigialis* differs from *Molothrus* and other icterids in lacking a distinctive flange on the tomium of the mandible. Although the size of the skull in *X. fastigialis* is roughly the same as in *M. ater*, the interorbital septum is much less extensively fenestrated, with the optic foramen not connected anteriorly to an interorbital fenestra as in *M. ater*. Furthermore, the portion of the cranial fenestra that is preserved in the holotype shows a broad, flat posteroventral surface, as opposed to the blade-like, mounded surface seen in *M. ater*. These traits of the cranial fenestra and interorbital septum argue that *X. fastigialis* is a cardueline, not an icterid (Zusi 1978). Convergence of drepanidine bill morphology toward that of icterids is also exhibited by the new genus of thin-billed gaping birds, *Aidemia*, and by *Loxops sagittirostris*.

Fossils of *X. fastigialis* occur commonly on the three adjacent islands of Oahu, Molokai, and Maui, making this the most widely-distributed of the new fossil species. Possibly its former distribution was similar to that of *Psittirostra psittacea*, *Himatione sanguinea*, and *Vestiaria coccinea*, which occurred historically on all six of the larger islands without exhibiting geographic differentiation in phenotypic characters. The disappearance of *X. fastigialis* throughout its range serves as a reminder that extinction affected broadly distributed species along with the more restricted ones.

#### Genus Incertae Sedis, Additional Oahu Finch

"cf. *Psittirostra*, additional Oahu Finch" Olson and James, 1982b:40.

"*Psittirostra* (subgenus incertae sedis) additional Oahu finch" Olson and James, 1982b:45.

*Material:* Right articular end of a mandible, USNM 255351.

*Distribution:* Oahu: Barbers Point.

*Measurements (mm):* Length of lateral cotyla, 3.5; length of lateral cotyla plus retroarticular process, 4.2; height of mandible at lateral cotyla, 2.0.

*Remarks:* In this fragment of a sturdy finch-like mandible, the retroarticular process has a most unusual form, consisting of a dorsally-projecting knob-like process rather than the expected posteriorly-projecting blade-like process. Assuming we have correctly attributed the bone to the Drepanidini, there is no doubt that it represents an undescribed species. We were able to rule out *Dysmorodrepanis munroi* after we removed the skull and mandible from the unique holotype of this species (James et al. 1989), and we had previously eliminated all other contenders. Formal diagnosis of the species must be deferred until better specimens of it are found.

#### Genus *Hemignathus* Lichtenstein, 1839

In certain recent sources (Berger 1981; American Ornithologists' Union 1983; Pratt et al. 1987), the amakihi (*Loxops stejnegeri*, *L. virens*, *L. parvus*, and *L.*

*sagittirostris*) have been merged with the genus *Hemignathus*, following Pratt (1979). We disagree with this and concur with earlier writers (e.g., Wilson and Evans 1890–1899; Perkins 1903; Amadon 1950), who included only the akialoas and “heterobills” in *Hemignathus*. These species are distinguished from other drepanidines by their very long and thin sickle-shaped premaxillae, with the nasals dramatically constricted anteriorly, and by possessing a greatly enlarged medial groove on the ventral maxilla (Olson and James 1988). The medial groove may function as a conduit for blood vessels and nerves, and its great size in *Hemignathus* may indicate that the tip of the bill in these probing birds experiences relatively rapid growth (Richard L. Zusi, pers. comm.). The amakihis are further distinguished from *Hemignathus* in lacking the plantaris muscle (Raikow 1976, 1977).

The species we include in *Hemignathus* are divisible into two distinct groups; the “heterobills” (*H. lucidus* and *H. wilsoni*), which have the mandibular rostrum only about half as long as the maxillary rostrum, and the akialoas (*H. stejnegeri*, *H. lichtensteini*, *H. lanaiensis*, and *H. obscurus*), which have the mandibular rostrum nearly as long as the maxillary rostrum. The morphological distance between these groups is great enough that they arguably belong in separate genera. In an earlier paper (Olson and James 1982b) we separated them as *Hemignathus* and *Heterorhynchus*, as had some previous authors, although we now realize that this nomenclatural treatment is erroneous because both generic names have the same type species. The following new species has a long mandibular symphysis.

***Hemignathus upupirostris*, new species**

(Fig. 25B–E)

“Hoopoe-like sickle-bill” Olson and James, 1982b:41, 45; 1984:771; James, 1987:225.

*Holotype*: Mandible lacking most of both articular ends, USNM 254171 (Fig. 25B, D). Collected 17 August 1976 by Storrs L. Olson, C. John Ralph, Carol P. Ralph, and John Luther.

*Type locality*: Site K-2, Makawehi dunes, Kauai, Hawaiian Islands.

*Distribution*: Kauai: Makawehi dunes. Oahu: Barbers Point.

*Etymology*: “Hoopoe-billed,” from Latin, *upupa*, the hoopoe, plus *rostrum*, beak; in reference to the convergent similarity of the mandible to that of *Upupa epops*.

*Measurements (mm) of holotype*: Length of tomial crest, 25.9+; symphysis length, 20.1+; greatest width of symphysis, 4.3; symphysis height, 1.6; height at lateral cotyla, 1.4; height at angle of mandible, 2.0; ramus length (middle part), 13.2.

*Paratypes*: Oahu, Barbers Point: two fragments of mandibular symphyses, USNM 255211 (Fig. 25C) and 255304 (Fig. 25E).

*Measurements of paratypes*: No meaningful measurements can be taken of the paratypes because of their fragmentary nature.

*Diagnosis*: A bird with a very long, attenuated and decurved mandible, resembling that of *Hemignathus stejnegeri*, *H. lichtensteini*, *H. lanaiensis*, and *H. procerus*, as opposed to the heterobills, *H. lucidus* and *H. wilsoni*. This species is distinguished from all other drepanidines by having virtually lost the lingual trough in the mandibular symphysis, this trough being extremely shallow and

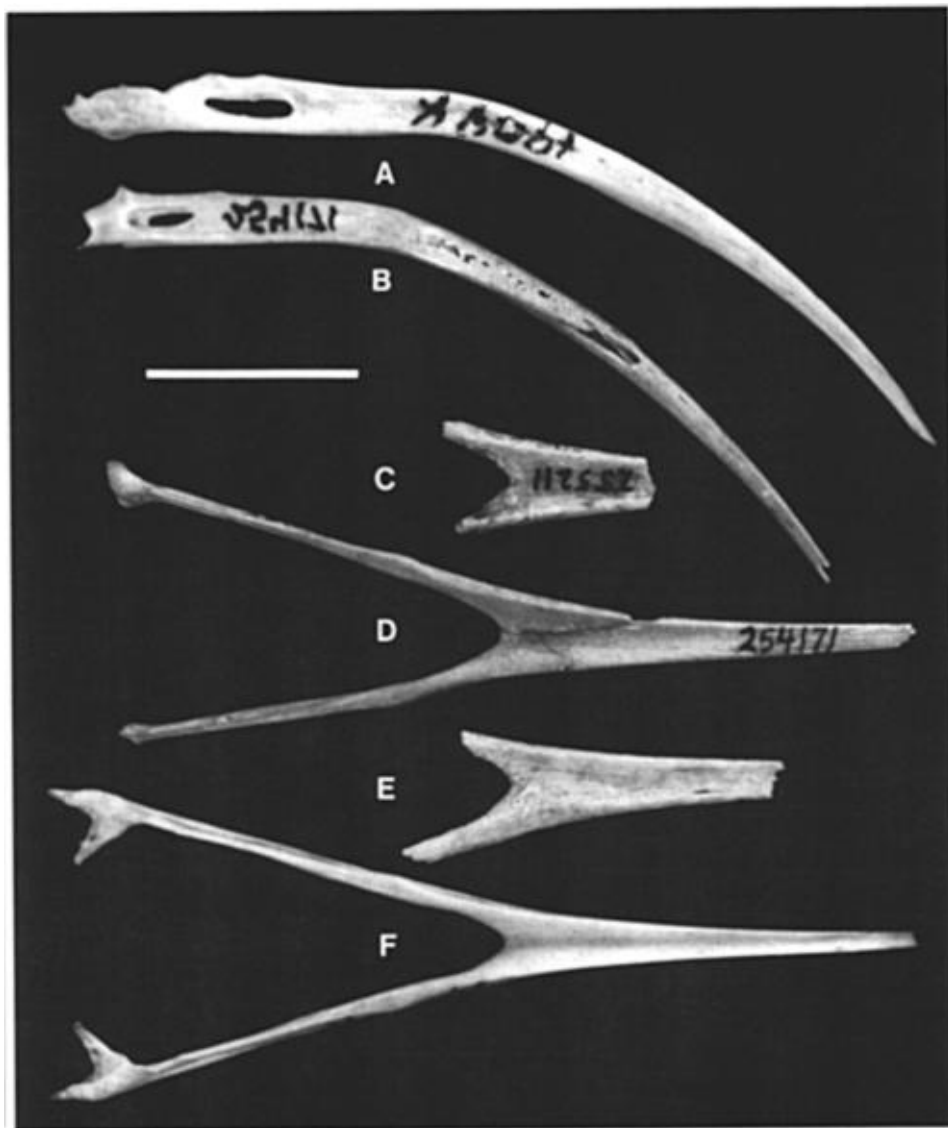

FIG. 25. Mandibles of *Hemignathus stejnegeri* (*H. procerus* auct.) and *H. upupirostris*, new species. A, lateral and F, dorsal views of *H. stejnegeri* (USNM 19094); B, lateral and D, dorsal views of *H. upupirostris*, holotype (USNM 254171; lateral view is of the left side printed in reverse); C, dorsal view of proximal portion of symphysis of *H. upupirostris* (USNM 255211); E, dorsal view of symphysis lacking tip of *H. upupirostris* (USNM 255304). Scale = 1 cm.

limited in extent to the caudal three-eighths of the elongated symphysis. The anterior five-eighths of the dorsal surface of the mandible has a flat cross-section instead of being deeply excavated.

The mandible also differs from that in a skeleton of *H. stejnegeri* in being slightly larger, with the coronoid processes displaced anteriorly. It is much longer than the mandibles of *H. lucidus* or *H. wilsoni*. The portion of the articular end



preserved in the holotype does not exhibit the modifications for hammering that are apparent in *H. wilsoni* (Zusi 1987).

*Remarks:* The holotype and two paratypes are the only specimens that we have identified as *H. upupirostris*. We have not succeeded in associating a maxilla with this species: either it is morphologically inseparable from *H. stejnegeri* or we have not collected it yet.

It might be questioned whether the fossils we have described as *H. upupirostris* are not in fact from the extinct Oahu Akialoa, *H. lichtensteini*. This is not the case, however, because the only two existing specimens of *H. lichtensteini* (ZMB 7918, holotype; ANSP 3360, previously misidentified as *H. stejnegeri*) have a pronounced lingual trough in the mandible (pers. observ.).

We infer from the shape of the mandible that the tongue of *H. upupirostris* was shorter than the long, tubular organ in *H. obscurus* or *H. stejnegeri*. Lacking a trough on the anterior part of the mandible, the bill probably could not have accommodated such a long tongue.

Although no other drepanidine lacks a well-developed trough on the dorsal surface of the mandible, this condition does occur in the hoopoes, woodhoopoes, and scythebills (Upupidae, Phoeniculidae, and Dendrocolaptinae: *Campylorhamphus*), with which *H. upupirostris* shares a convergent bill morphology (Olson and James 1982b).

#### *Vangulifer*, new genus

*Type species:* *Vangulifer mirandus*, new species.

*Included species:* *Vangulifer mirandus*, new species; *Vangulifer neophasis*, new species.

*Distribution:* Maui: lava tubes on the southern slopes of Haleakala Volcano.

*Etymology:* "Little shovel bearer," from Latin, *vangula*, diminutive of *vanga*, a shovel, and the suffix *-ifer*, bearer, in allusion to the peculiar, blunt, somewhat spatulate appearance of the bill. The gender is masculine.

*Diagnosis:* Drepanidines with long and delicate, rather than finch-like bills, distinguished from all other passerines we have examined by the long and broad, fairly deep bill culminating in a very blunt, rounded tip. Among drepanidines, the combination of a long bill with a somewhat rounded tip occurs also in *Aidemia*, from which *Vangulifer* differs in having the bill shorter and broader, with a slight lateral constriction of the maxilla, and a much shorter retroarticular process of the mandible.

*Vangulifer* differs further from the finch-billed drepanidines in having antero-posteriorly elongated narial openings, very weakly developed and posterolaterally confined lateral ridges on the ventral maxilla, and in having a delicate mandible with the symphysis long and thin-walled and the middle part of the ramus narrow and straight. The middle part of the ramus is not abruptly deflected downward, as it is in the highly nectarivorous drepanidines in Perkins' (1903) Division 1 (*Himatione*, *Vestiaria*, *Palmeria*, *Drepanis*, and *Ciridops*). The retroarticular process is weakly developed as compared to those genera, and to *Loxops* and *Aidemia*. As in some finch-billed and most thin-billed drepanidines, the postero-ventral edge of the maxilla is V-shaped. The medial groove on the ventral maxilla exhibits a peculiar development: The main groove that in other genera extends straight from the posterior edge to the tip, is shallow in *Vangulifer* and is played

anteriorly into numerous accessory grooves that extend outward toward the lateral edges of the bone.

*Remarks:* Despite the reduced size of the articular end of the mandible in *V. mirandus*, *Vangulifer* is unlikely to belong with the species in Perkins' Division 1, which are set apart by their deflected mandibular rami, long and delicate retroarticular processes of the mandibles, and their more laterally constricted and pointed bills. The various morphologies that are accommodated within the genus *Loxops* are either more finch-like (e.g., *L. coccineus*) or more similar to the species of Division 1, than is that of *Vangulifer*. *Vangulifer* may be related to *Aidemedia*, which has a blunt bill tip and some evidence of weak splaying of the medial groove. Other possible relatives are *Paroreomyza*, which lacks a pronounced retroarticular process and has a very delicate, yet pointed bill, and the Kauai Creeper *Oreomystis bairdi*, in which the retroarticular process is shaped like that of *V. neophasis*.

Because *Vangulifer* can never be observed in life, it is impossible to know exactly how the blunt bill was used in foraging. Although the most reasonable guess might be derived through analogy with living forms that exhibit closely similar morphology, we have so far failed to find a satisfactory living analog for *Vangulifer*. Its bill seems too long and weak to be designed for seed cracking; too deep and broad to be suited for probing in bark; too blunt for a nectarivore; and with its weak retroarticular processes, unlikely to have been used for forceful gaping. Thrushes have broad, weak bills, but these are more pointed than in *Vangulifer*. Although we have entertained the possibility that *Vangulifer* used its bill to snap up insects on the wing, todies (Todidae) and flycatchers (Tyrannidae) exhibit more dorsoventral compression of the bill than does *Vangulifer* (see additional discussion in the remarks under *V. mirandus*).

A clue to the use of the bill may exist in the distinctive splaying of the medial groove on the ventral surface of the maxilla. This might function to distribute the blood supply and/or nerves over the entire ventral surface of the maxilla, or to its lateral edges, rather than directly to the tip.

No associated complete or partial skeletons of *Vangulifer* have been found. In identifying the following two new species, we have therefore relied on the conformity of the jaws and on the distribution of each morphotype at the various cave localities to predict which maxillae probably belong with which mandibles. We identified two maxillae and seven partial mandibles from Puu Naio Cave, and one maxilla from Lua Lepo, as *V. mirandus* (minimum 5 individuals). To *V. neophasis*, we assigned 3 maxillae and 2 mandibular symphyses from Puu Makua Cave, one mandible from Lua Lepo, and 4 maxillae and 12 partial mandibles from Puu Naio Cave (minimum 9 individuals).

***Vangulifer mirandus*, new species**  
(Figs. 26D–F, 27B, D)

“two new thin-billed drepanidine species” (part), James et al., 1987:2353.

*Holotype:* Maxilla lacking the left lateral nasal bar, USNM 445807 (Fig. 26D–F). Collected 23 March 1988 by H. F. James.

*Type locality:* Puu Naio Cave (305 m), Maui, Hawaiian Islands.

*Distribution:* Maui: Puu Naio Cave and Lua Lepo.

*Etymology:* Latin, *mirandus*, wonderful, strange.

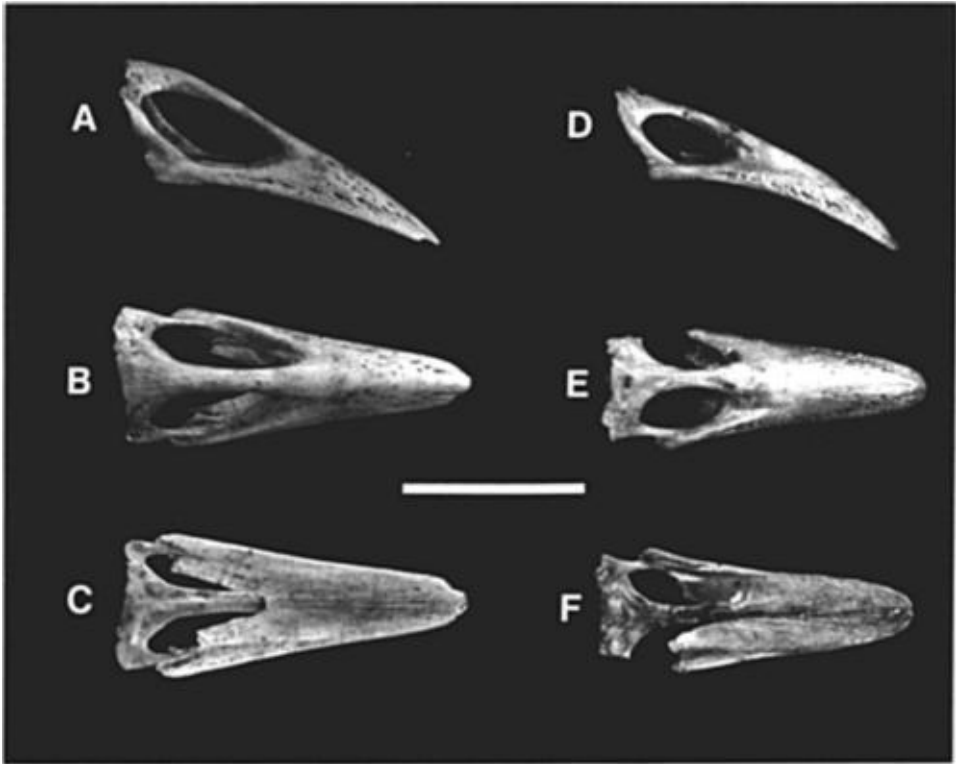

FIG. 26. Maxillae of *Vangulifer*, new genus. A, lateral, B, dorsal and, C, ventral views of *V. neophasis*, new species, holotype (USNM 447061); D, lateral, E, dorsal and F, ventral views of *V. mirandus*, new species, holotype (USNM 445807). Scale = 1 cm.

*Measurements (mm) of holotype:* Dorsal length, 18.4; ventral length, 12.4; length from lateral corner of nasofrontal hinge, 18.9; length from jugal articulation, 15.7; length from anterior margin of narial opening, 11.5; maximum width, approximately 7.4; length of narial opening, 5.4; height of narial opening, 3.1; height through lateral nasal bar, 5.8; minimum width of dorsal nasal bar, 1.0.

*Paratypes:* Maxilla lacking the nasal bars, USNM 445806; slightly damaged mandible consisting of the symphysis and the right ramus, USNM 445808 (Fig. 27B, D).

*Measurements (mm) of paratypes:* Maxilla: ventral length, 11.2; length from jugal articulation, 16.0; length from anterior margin of narial opening, 11.1; maximum width, 7.2. Mandible: total length, 28.2; length of tomial crest, 14.6; symphysis length, 9.8; greatest width of symphysis, 6.3+; symphysis height, 2.4; length of lateral cotyla, 2.8; length of lateral cotyla plus retroarticular process, 3.0; height at lateral cotyla, 1.4; height at angle of mandible, 2.6; length of ramus (middle part), 12.1.

*Diagnosis:* Compared to *Vangulifer neophasis*, the maxilla is more decurved and not nearly as deep, the narial opening is much smaller, the entire ventral surface of the maxilla is much less excavated and is more distinctly pitted antero-medially, the splaying of the medial groove is more pronounced, and the tomial



FIG. 27. Mandibles of *Vangulifer*, new genus. *A*, lateral and *C*, dorsal views of *V. neophasis*, new species (USNM 445813; lateral view is of the left side printed in reverse); *B*, lateral and *D*, dorsal views of *V. mirandus*, new species (USNM 445808). Scale = 1 cm.

crest is flared laterally toward the jugal articulations, as opposed to being straight. While the mandible is similar in overall size to that of *V. neophasis*, the articular end is smaller and the retroarticular process is much shorter.

*Remarks:* In several characters, *V. mirandus* is more similar to aerial insectivores than is *V. neophasis*. The maxilla is not as deep, its ventral surface is nearly flat rather than domed, and the articular end of the mandible is reduced in size. However, a curved bill would not be expected in a bird that fed exclusively by catching insects on the wing.

***Vangulifer neophasis*, new species**  
(Figs. 26A–C, 27A, C)

“two new thin-billed drepanidine species” (part), James et al., 1987:2353.

*Holotype:* Slightly damaged maxilla, USNM 447061 (Fig. 26A–C). Collected 10 June 1988 by H. F. James.

*Type locality:* Puu Naio Cave (305 m), Maui, Hawaiian Islands.

*Distribution:* East Maui: Puu Naio Cave, Lua Lepo, and Puu Makua Cave.

*Etymology:* Greek, *neos*, new, plus *phasis*, appearance, look; from the novel appearance of the bill. The name is a feminine noun in apposition.

*Measurements (mm) of holotype:* Dorsal length, 19.6; ventral length, 10.7; length from lateral corner of nasofrontal hinge, 19.8; length from jugal articulation, 16.5; length from anterior rim of narial opening, 7.7; ventral width, 7.6; length of narial opening, 7.7; height of narial opening, 3.8; height through lateral nasal bar, 7.2; minimum width of dorsal nasal bar, 1.2.

*Paratypes:* Puu Naio Cave: maxilla lacking the left nasal bar, USNM 445809; mandible lacking the posterior half of the right ramus, USNM 445813 (Fig. 27A, C).

Puu Makua Cave: Three damaged maxillae, USNM 445810, 445811, and 445812.

*Measurements (mm) of paratypes:* Maxillae (in the order listed above): dorsal length, 20.8+, 20.6+, —, —; ventral length, 11.5, 11.8, —, —; length from lateral corner of nasofrontal hinge, 20.8, 20.7, —, —; length from jugal articulation, 17.3, 17.1, —, —; length from anterior rim of narial opening, 10.9, 10.6, —, —; maximum width, 7.5, 8.0, —, 7.3; length of narial opening, 7.7, 6.9, 7.7, 7.6; height of narial opening, 4.2, 3.7, 4.0, 3.7; height through lateral nasal bar, 7.8+, 7.7+, —, 8.0+; minimum width of dorsal nasal bar, 1.2, 1.2, 1.2, 1.0.

Mandible (approximately 2 mm should be added to length measurements to compensate for the damaged tip): total length, 29.6+; length of tomial crest, 16.1+; symphysis length, 9.8+; greatest width of symphysis, 6.8; symphysis height, 2.6; width of articular end with medial process, 4.4; height at lateral cotyla, 1.8; height at angle of mandible, 2.9; length of ramus (middle part), 11.8.

*Diagnosis:* Compared to *V. mirandus*, the maxilla is straighter and deeper, the narial openings are larger, the entire ventral surface of the maxilla is much more excavated, and the tomial crests are not flared outward towards the jugal articulations. The ventral surface of the maxilla is less distinctly pitted anteromedially, and the splaying of the medial groove is less pronounced. The mandibular articulation is relatively large and has a longer retroarticular process compared to *V. mirandus*. While the retroarticular process exhibits individual variation in depth, it is shorter and sturdier than in *Loxops*, *Himatione*, *Vestiaria*, *Palmeria*, *Drepanis*, or *Ciridops*.

This is a medium-sized drepanidine, the mandibular ramus posterior to the tomial crest being comparable in length to *Palmeria dolei*.

*Remarks:* The differences between *V. neophasis* and *V. mirandus* are great enough that these species might have been described as separate genera. The shared characters that influenced our decision to unite them are the blunt bill, splayed medial groove, and short retroarticular processes, combined with a delicate, elongate bill.

#### *Aidemia*, new genus

*Type species:* *Aidemia lutetiae*, new species.

*Included species:* *Aidemia lutetiae*, new species; *A. chascax*, new species; *A. zanclops*, new species.

*Distribution:* Oahu, Molokai, and Maui.

*Etymology:* To Joan Aidem, resident of Molokai and pioneer collector of fossil birds in the Hawaiian Islands. The word has no relationship with the Greek root *aidemon*, meaning bashful or modest (cf. *Aidemonia*, Nectariniidae; *Aidemosyne*, Estrildidae). The unusual terminal orthography results from our inability to resist creating a palindrome. The name is to be regarded as feminine in gender.

*Diagnosis:* Drepanidine birds with sturdy, straight or decurved, very elongate bills, with extremely long retroarticular processes on the mandibles. Within drepanidines, the combination of an elongate bill and moderately to well-developed retroarticular processes also occurs in *Hemignathus*, *Loxops*, *Himatione*, *Palmeria*, *Vestiaria*, and *Drepanis*. *Aidemia* differs from these in having the bill narrower posteriorly; the maxilla is nearly uniform in breadth as opposed to being expanded posteriorly; and the dorsal nasal bar is also of uniform breadth, rather than broadening anteriorly as in the other genera. The retroarticular processes are longer and sturdier than in any of the aforementioned taxa except *Loxops sagittirostris*. *Aidemia* is further distinguished from *Hemignathus* in having a much less attenuated maxilla with a shallower medial groove. *Aidemia* differs further from *Himatione*, *Palmeria*, *Vestiaria*, and *Drepanis* in the sturdier construction of the bill, the relatively large articular end of the mandible, the fairly straight rather than abruptly deflected anterior portion of the mandibular ramus, and the less excavated ventral surface of the maxilla. *Aidemia* differs further from *Loxops* in having the anterior edge of the narial opening not defined by a clear rim. Among drepanidines, *Aidemia* is most similar in general bill morphology to *Loxops sagittirostris*, but differs in the characters mentioned above and also in the larger bill and less pronounced retroarticular notch on the mandible.

The maxilla has the ventral ridges and lateral troughs weakly developed and confined posterolaterally, with a moderately excavated medial trough occupying most of the ventral surface. These conditions are typical of long-billed drepanidines. The medial groove is shallow with some weakly defined accessory grooves radiating from it anteriorly in a configuration that resembles the distinctly splayed groove of *Vangulifer mirandus*.

*Remarks:* Pronounced retroarticular processes on the mandible occur in birds that employ forceful gaping to obtain food, including a variety of passerine species. Beecher (1951) describes the use of gaping by *Sturnus vulgaris* and various icterids to feed in such diverse substrates as flowers, fruit, grass, bark, and earth. It seems likely that *Aidemia* fed similarly.

Despite its general similarity of bill shape to *L. sagittirostris*, *Aidemia* exhibits some characters that suggest its relationships may lie elsewhere within the drepanidine radiation. For instance, the flattened dorsal nasal bar is shared with *Xestospiza fastigialis*, and the blunt bill tip and weak splaying of the medial groove of the maxilla are reminiscent of *Vangulifer*.

***Aidemia chascax*, new species**  
(Figs. 28H, I, J, 29B, 30B)

"Icterid-like gaper, Oahu" Olson and James, 1982b:41, 45; 1984:771.

*Holotype:* Mandible with slightly damaged symphysis, lacking the right articular end and part of the right ramus (middle part), BBM-X 155523 (Figs. 29B, 30B). Collected July or August 1977 by Aki Sinoto and others.

*Type locality:* Site 50-Oa-B6-100b, Barbers Point, Oahu, Hawaiian Islands.

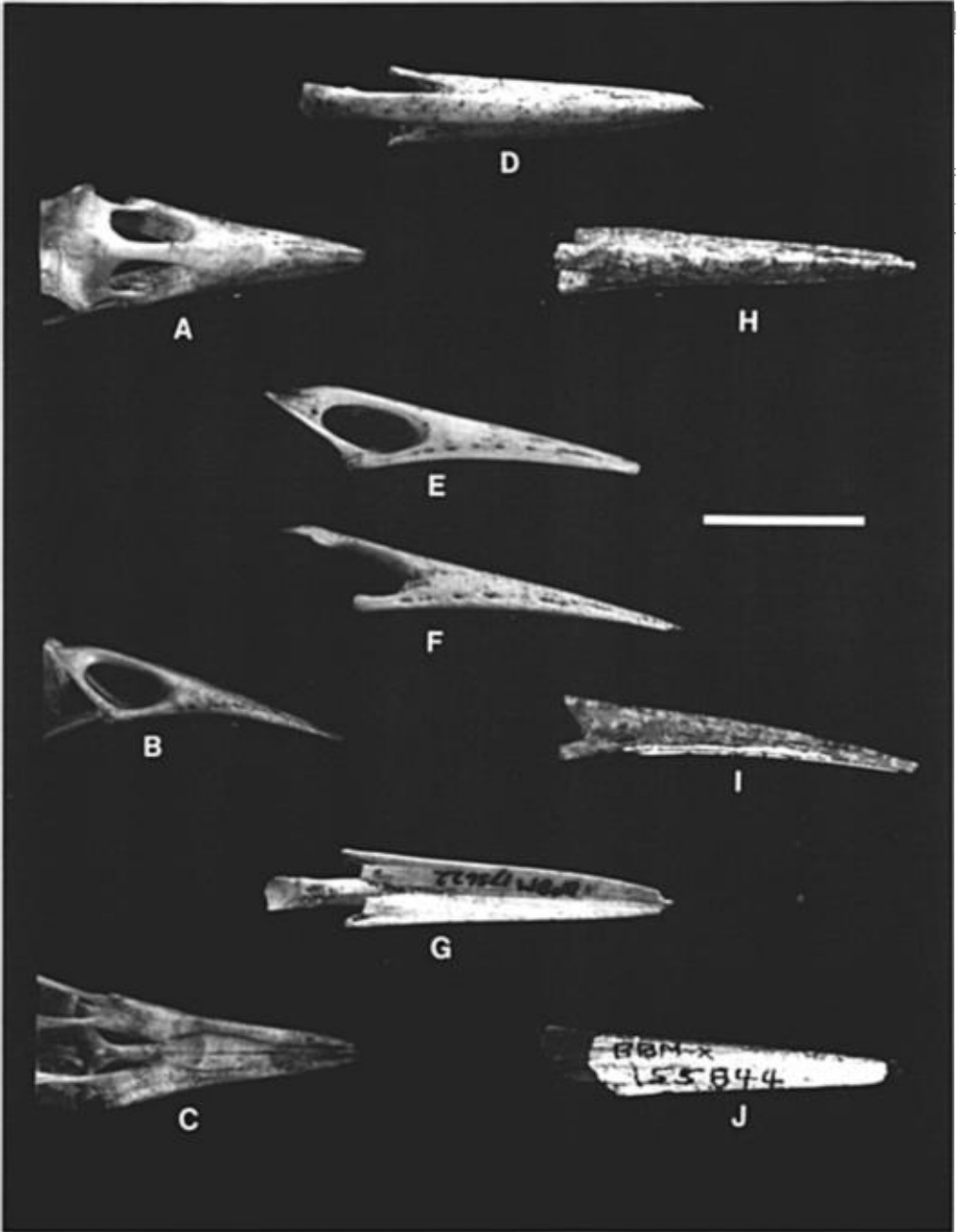

FIG. 28. Maxillae of *Aidemia*, new genus, and *Loxops sagittirostris*. *A*, dorsal, *B*, lateral and *C*, ventral views of *L. sagittirostris* (AMNH 453236); *D*, dorsal, *F*, lateral and *G*, ventral views of *A. lutetiae*, new species (BPBM 175622); *E*, lateral view of *A. lutetiae* (USNM 445816); *H*, dorsal, *I*, lateral, and *J*, ventral views of *A. chascax*, new species (BBM-X 155844). Scale = 1 cm.

TABLE 11  
MEASUREMENTS (MM) OF THE MAXILLA AND MANDIBLE IN *Aidemia* COMPARED  
TO *Loxops sagittirostris*. H = HOLOTYPE

	<i>Aidemia lutetiae</i>	<i>Aidemia chascax</i>	<i>Aidemia zanclops</i>	<i>Loxops sagittirostris</i>
<b>Maxilla:</b>				
Ventral length	17.3, 17.8, 18.2	20.0	—	12.4
Length from jugal articulation	19.8, 20.0, 21.7	—	—	15.7
Length from anterior narial opening	14.2, 16.6, 17.4	20.0	—	11.6
Minimum width of dorsal nasal bar	1.6, 1.6, 1.7, 1.7	1.6	—	1.0
<b>Mandible:</b>				
Total length	34.6, 36.4 H	43.6 H	39.8 H*	30.2
Length of tomial crest	17.1, 19.6 H	22.6 H	24.6 H	15.0
Symphysis length	13.2, 15.2 H	17.5 H	20.0 H	10.7
Greatest width of symphysis	5.5, 5.8 H	6.3 H	5.6 H	6.3
Greatest width of mandible	14.4 H	—	—	12.7
Symphysis height	2.6, 3.0 H	2.8 H	2.3 H	2.0
Length of lateral cotyla	3.9, 4.0, 4.1 H	4.6 H	4.0 H	3.2
Length of lateral cotyla with retroarticular process	7.6 H, 7.6, 7.7	8.6 H	—	6.0
Width of articular end with medial process	4.6, 5.0, 5.1 H	5.5 H	—	3.8
Height at lateral cotyla	2.4, 2.7 H, 2.9	2.5 H	2.3 H	2.0
Height at angle of mandible	3.1, 3.5 H, 3.5	3.1 H	2.7 H	2.7
Ramus length (middle part)	10.8 H, 11.7, 11.7	13.8 H	12.9 H	10.6

\* Approximately 4 mm should be added to the mandible length of *A. zanclops* to compensate for the missing retroarticular process.

*Distribution:* Oahu: Barbers Point. It is as yet uncertain whether fragmentary Pleistocene fossils assigned to *Aidemia* ("icterid-like gaper" James 1987:225) from Ulupau Head on Oahu also belong to this species.

*Etymology:* Greek, *chascax*, a gaper; from the adaptation of the bill for gaping. The name is a masculine noun in apposition.

*Measurements of holotype:* See Table 11.

*Paratypes:* Maxilla lacking posterior portion, BBM-X 155844 (Fig. 28H, I, J); two nearly intact mandibular symphyses, USNM 445814 and BBM-X 154918; fragment of left side of mandible, USNM 255564; tip of mandibular symphysis, USNM 255125.

*Measurements of paratypes:* See Table 11.

*Diagnosis:* The very straight, sturdy bill resembles that of *Aidemia lutetiae*, but is longer and has the dorsal surface of the maxilla less flattened. Also, the retroarticular process is deeper and is displaced ventrally, and the mandibular ramus (middle part) is not angled downward as strongly. The mandible is broader and less decurved than in *A. zanclops*.

*Remarks:* See the following species.

*Aidemia zanclops*, new species  
(Figs. 29C, 30A)

"Sickle-billed gaper, Oahu" Olson and James, 1982b:41.

"Sickle-billed gaper" Olson and James, 1982b:45; James, 1987:225.

*Holotype:* Mandible lacking the posterior end of the right ramus, with the medial and retroarticular processes missing from the left articular end, BBM-X 155160





FIG. 29. Mandibles of *Aidemedia*, new genus, and *Loxops sagittirostris* in lateral view. A, *A. lutetiae*, new species, holotype (BBM-X 147441); B, *A. chascax*, new species, holotype (BBM-X 155523); C, *A. zanclops*, new species, holotype (BBM-X 155160; the catalog number on the posterior part of the specimen, BBM-X 155177, is now obsolete); D, *L. sagittirostris* (ANMH 453236). Scale = 1 cm.

(Figs. 29C, 30A). Collected July or August 1977 by Aki Sinoto and others. The left posterior ramus had been separated from the rest of the bone probably while still in the fossil site, and was originally assigned catalog number BBM-X 155177 before it was recognized and re-attached. BBM-X 155160 is the correct catalog number for the entire specimen.

*Type locality:* Site 50-Oa-B6-78, Barbers Point, Oahu, Hawaiian Islands.

*Distribution:* Oahu: known so far only from the type locality, although fragmentary fossils from Ulupau Head may represent the same species (James 1987).

*Etymology:* Greek, *zanclon*, a sickle, plus *ops*, face; from the long, decurved mandible. The name is a masculine noun in apposition.

*Measurements of holotype:* See Table 11.

*Diagnosis:* The mandible differs from other species of *Aidemia* in being narrower and more gracile, and in having a decurved rather than straight symphysis, although the degree of curvature is slight compared to other sickle-billed drepanidines (*Drepanis*, *Vestiaria*, and *Hemignathus*). In its elongation the mandible resembles *A. chascax* more than *A. lutetiae*.

*Remarks:* With its narrow, decurved bill, this is certainly the most divergent of the three species of *Aidemia*, yet in being elongated the bill is rather unexpectedly more similar to the sympatric species *A. chascax* than to the evidently allopatric *A. lutetiae*. Possibly the straight-billed (*A. chascax*) and curved-billed (*A. zanclops*) forms of *Aidemia* from Oahu are males and females of a single, highly dimorphic species. Among passerines, a comparable extreme of sexual dimorphism in bill shape is reached only by the Huia, *Heteralocha acutirostris* (Callaeidae), of New Zealand, so that the possibility of this occurring in *Aidemia* must be considered slight, particularly since no such dimorphism appears to be present in *A. lutetiae* of Molokai and Maui.

***Aidemia lutetiae*, new species**  
(Figs. 28D–G, 29A, 30C)

“Icterid-like gaper, Molokai” Olson and James, 1982b:41, 45; 1984:772.

*Holotype:* Mandible with slight damage to the tip and mandibular foramina, BBM-X 147441 (Figs. 29A, 30C). Collected between September 1972 and January 1974 by Joan Aidem.

*Type locality:* Site 10, Moomomi dunes, Molokai, Hawaiian Islands.

*Distribution:* Molokai: Moomomi dunes. Maui: Puu Naio Cave, Lua Lepo, and Puu Makua Cave.

*Etymology:* Latin, of Lutetia, the ancient Gallic capital of the Parisii, in allusion to the fact that members of this species must have spent their lives in gaperly.

*Measurements of holotype:* See Table 11.

*Paratypes:* Molokai, Moomomi dunes: two maxillae, both lacking lateral nasal bars, BBM-X 152622 and BPBM 175622 (Fig. 28D, F, G); a mandible lacking the posterior half of the left ramus, USNM 445818.

Maui, Puu Naio Cave: Maxilla lacking right lateral nasal bar, USNM 445815; the posterior half of a right mandibular ramus, USNM 445817. Lua Lepo: Maxilla lacking the left lateral nasal bar, USNM 445816.

*Measurements of paratypes:* See Table 11.

*Diagnosis:* This species is distinguished from *A. chascax* and *A. zanclops* by its shorter, very straight bill and by having the dorsal maxilla flattened. The flat

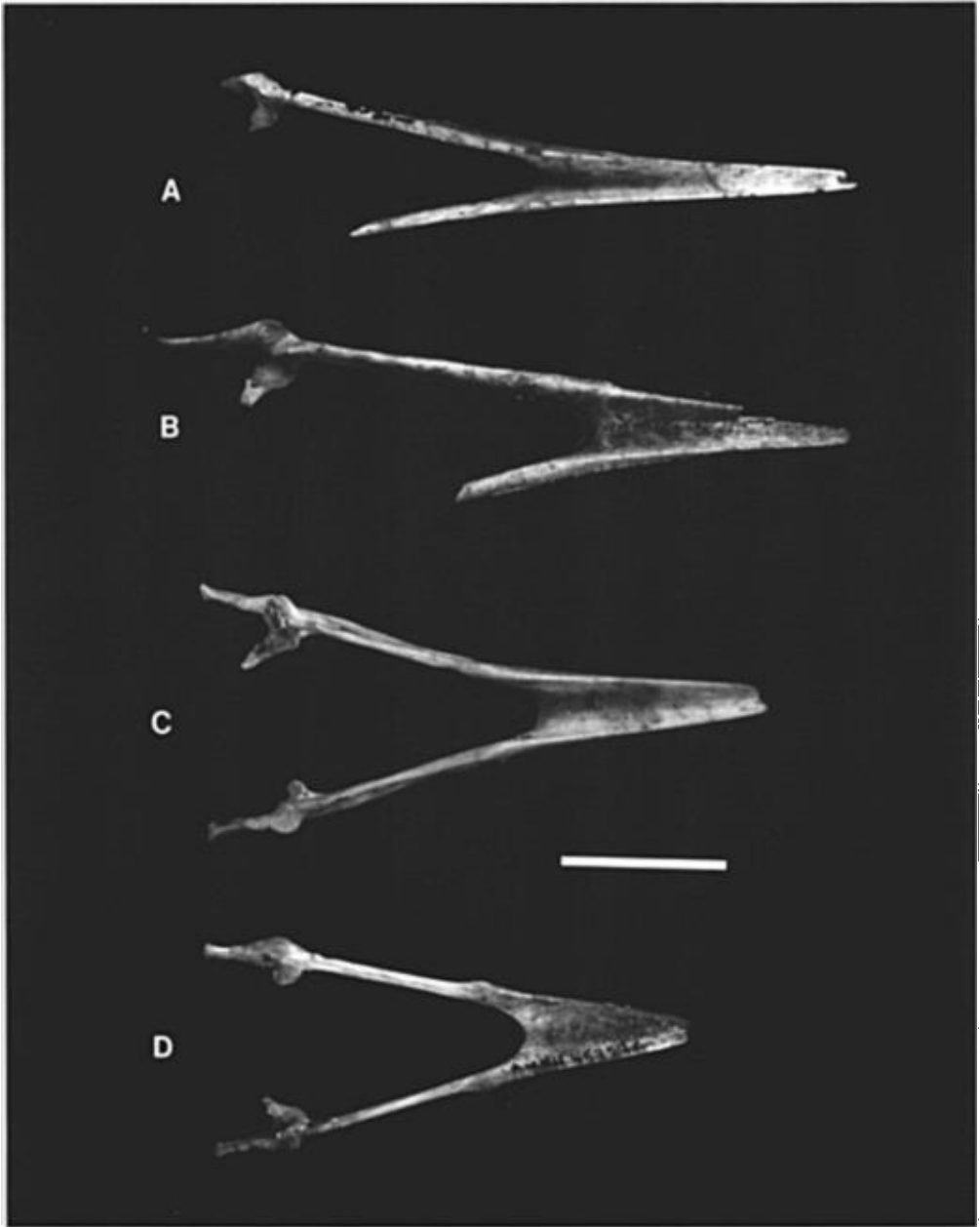

FIG. 30. Mandibles of *Aidemediina*, new genus, and *Loxops sagittirostris* in dorsal view. A, *A. zanclops*, new species, holotype (BBM-X 155160); B, *A. chascax*, new species, holotype (BBM-X 155523); C, *A. lutetiae*, new species, holotype (BBM-X 147441); D, *L. sagittirostris* (AMNH 453236). Scale = 1 cm.

surface extends anteriorly from the dorsal nasal bar until it becomes indistinct about mid-way to the tip. *A. lutetiae* is further distinguished from *A. chascax* by having the mandibular symphysis angled slightly downward relative to the middle part of the ramus.

*Remarks:* The bill of *A. lutetiae* resembles that of meadowlarks of the genus *Sturnella* (Icteridae), which also have long, straight bills with pronounced retroarticular processes on the mandible and a similarly flattened upper surface of the maxilla. We are confident that this similarity of bill shapes is correctly attributed to convergence rather than to genealogical relationship. Icterids possess a distinctive flange on the mandibular tomium that *Aidemia* lacks. Characters of *Aidemia* that occur commonly in drepanidines but not in icterids are the relatively long mandibular symphysis, the lack of a distinct intercotylar tubercle on the mandible, and the excavated ventral surface of the maxilla.

#### Genus *Ciridops* Newton, 1892

The sole previously described species in this genus, *Ciridops anna*, was known from only five museum specimens, three taken on the island of Hawaii, and two of unknown origin. None were originally preserved as skeletons, so we removed bones from a skin and a trunk preserved in alcohol (see Comparative Material Examined), from which we learned that the pelvic appendage in *Ciridops* is much stouter than in related taxa (the other members of Perkins' (1903) Division 1, i.e., *Himatione*, *Palmeria*, *Vestiaria*, and *Drepanis*). While the tarsometatarsus in some of the finch-billed drepanidines is as stout as in *Ciridops*, the tibiotarsus and femur of *Ciridops* are stouter than in any other drepanidine. Associated with the robust hindlimb of *Ciridops* are dorsally expanded iliac shields of the pelvis. Similar but more extreme modifications of the pelvis and hindlimb occur in the passerine genera *Orthonyx* (Baird 1985), *Bowdleria*, and *Mohua* (Olson 1990a, b).

The very short, superficially finch-like bill, along with a fancied resemblance in plumage to the cardueline genus *Leucosticte*, led Richards and Bock (1973: 125) to propose that *Ciridops* is a primitive drepanidine. We do not find support for this idea in osteology. The maxilla and mandible of *Ciridops* are not like cardueline finches but are shortened versions of the thin, weak structures found in the nectarivorous genera *Himatione*, *Palmeria*, *Vestiaria*, and *Drepanis*. If the evidence for a cardueline origin of drepanidines is correct, then *Ciridops* and its relatives share a highly derived rather than a primitive osteology within the radiation.

*Ciridops* and the other genera in Perkins' Division 1 are osteologically quite similar to *Loxops*, from which their bills can be distinguished by a suite of minor characters. In Division 1, the anterior edge of the narial opening is not defined by a clear rim (true also of *Loxops parvus*). Further, the ventral surface of the maxilla is more excavated, the articular end of the mandible is small and weak, and the mandibular foramen is enlarged, compared to species of *Loxops* with bills of similar size.

In addition to its stout pelvic appendage, *Ciridops* can be distinguished from *Himatione*, *Palmeria*, *Vestiaria*, and *Drepanis* by its much shorter bill, constricted dorsal nasal bar, upturned retroarticular process of the mandible, deep mandibular ramus (middle part), and enlarged mandibular foramen.

We have identified fossils of *Ciridops* from Kauai, Oahu, and Molokai. Contrary to our previous assessment (Olson and James 1982b:42), the scant fossil material found so far on Molokai may not differ from *Ciridops anna*, so it is not discussed further here.

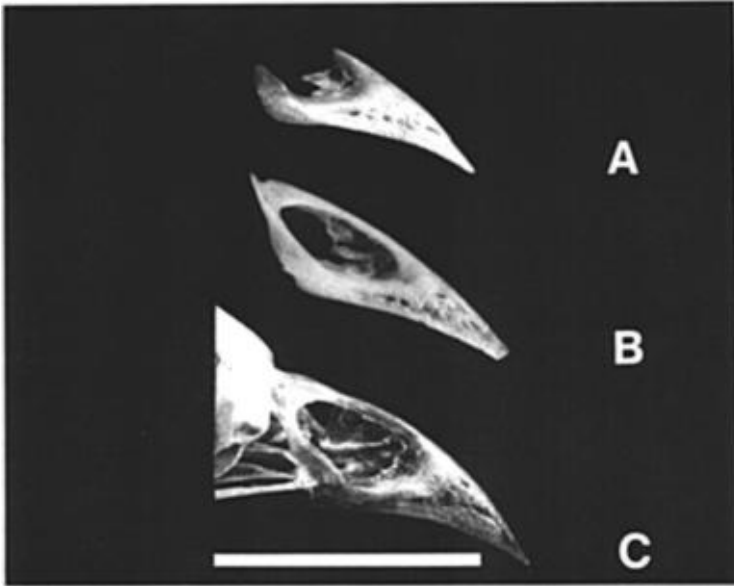

FIG. 31. Maxillae of *Ciridops* in lateral view. A, *Ciridops* sp., Oahu (BBM-X 155727); B, *C. tenax*, new species, holotype (USNM 254913); C, *C. anna* (MCZ 10995). Scale = 1 cm.

***Ciridops tenax*, new species**

(Figs. 31B, 32B, 33D, E, 34C, D, 35A–C, G–I)

“*Ciridops* sp., Kauai” Olson and James, 1982b:42, 45; 1984:771.

*Holotype*: Maxilla lacking right lateral nasal bar, USNM 254913 (Figs. 31B, 32B). Collected 17 August 1976 by Storrs L. Olson, C. J. Ralph, Carol P. Ralph, and John Luther.

*Type locality*: Site K-2, Makawehi dunes, Kauai, Hawaii.

*Distribution*: Kauai: Makawehi dunes.

*Etymology*: Latin, *tenax*, holding firmly; so named for the muscular leg and large, presumably grasping foot possessed by members of this genus.

*Measurements of holotype*: See Table 12.

*Paratypes*: Associated bones of one individual, USNM 254985, consisting of four fragments of the maxilla, the mandibular symphysis, right femur still in articulation with the acetabulum, the proximal end of the right tibiotarsus without the cnemial crest, the distal end of the right tarsometatarsus, and one pedal phalanx. The bones were cemented in a nodule of calcareous sand in the configuration of a regurgitated owl pellet (Olson and James 1982b:fig. 10). When the matrix was removed, this same pellet also yielded bones of one individual each of *Loxops stejnegeri* and *L. parvus*.

Maxilla lacking nasals, USNM 254607; three mandibular symphyses, USNM 254157 (Figs. 33E, 34D), 254158, 254159; right mandibular ramus, USNM 254969 (Figs. 33D, 34C); left articular end of the mandible lacking medial process, USNM 254971; synsacrum with the left half of the pelvis and the right iliac crest still fused, USNM 445819 (Fig. 35A); synsacrum, USNM 445820; three right femora, 254034, 254043, 254046, six left femora, USNM 254035, 254044 (Fig. 35C),

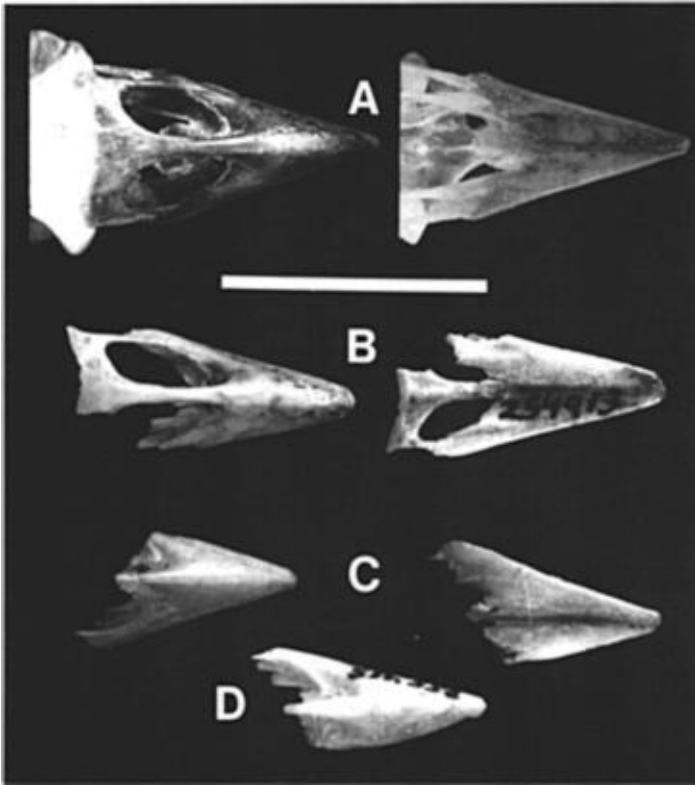

FIG. 32. Maxillae of *Ciridops* in dorsal (left) and ventral (right) views. A, *C. anna* (MCZ 10995); B, *C. tenax*, new species, holotype (USNM 254913); C, *Ciridops* sp., Oahu (BBM-X 155727); D, dorsal view of *Ciridops* sp., Oahu (USNM 255415). Scale = 1 cm.

TABLE 12  
MEASUREMENTS (MM) OF THE MAXILLA AND MANDIBLE IN *Ciridops*.  
H = HOLOTYPE

	<i>Ciridops tenax</i>	<i>Ciridops</i> sp., Oahu	<i>Ciridops anna</i>
<b>Maxilla:</b>			
Dorsal length	11.4 H	—	13.5
Length from jugal articulation	9.3 H, 9.9	8.6, 8.6, 9.2	9.4
Length from anterior narial opening	5.5 H, 6.4	5.3, 5.4, 5.4	6.1
Length of narial opening	4.5 H	—	5.0
Height of narial opening	2.3 H	—	2.6
Height through lateral nasal bar	5.2 H	—	6.0
Minimum width of dorsal nasal bar	0.6 H	0.5	0.7
<b>Mandible:</b>			
Symphysis length	5.8, 6.0, 6.2, 6.4	4.6, 4.7, 4.8, 5.1	5.9
Greatest width of symphysis	4.1	—	4.5
Symphysis height	1.5	—	1.8

TABLE 13

MEASUREMENTS (MM) OF THE POSTCRANIAL SKELETON IN *Ciridops*. MEAN, STANDARD DEVIATION, AND RANGE ARE GIVEN FOR SAMPLE SIZES GREATER THAN 4; DATA ARE LISTED INDIVIDUALLY FOR SAMPLE SIZES OF 4 OR FEWER

	<i>Ciridops tenax</i>	<i>Ciridops</i> sp., Oahu	<i>Ciridops anna</i>
Synsacrum length	10.6, 10.7	—	—
Femur length	13.4 ± 0.53 12.5–14.5 n = 10	13.5	14.8*
Femur, proximal width	3.0 ± 0.06 2.8–3.0 n = 9	3.4	3.8*
Femur, mid-shaft depth	1.1 ± 0.04 1.1–1.2 n = 10	1.3	1.3*
Femur, distal width	3.2 ± 0.11 3.0–3.3 n = 10	3.6	4.2*
Tibiotarsus length	26.2	—	29.0
Tibiotarsus, distal width	2.7	—	3.3
Tarsometatarsus length	19.9 ± 0.42 19.2–20.5 n = 8	18.5, 18.6, 19.9	21.6
Tarsometatarsus, proximal width	3.0 ± 0.13 2.8–3.2 n = 7	3.0, 3.0, 3.2	3.4
Tarsometatarsus, mid-shaft width	1.1 ± 0.07 1.0–1.3 n = 10	1.2, 1.3, 1.3	1.4
Tarsometatarsus, distal width	2.3 ± 0.08 2.1–2.4 n = 10	2.2, 2.3, 2.4	2.5

\* Femur measurements for *Ciridops anna* were taken from a fossil from Molokai.

254045 (Fig. 35B), 254240, 254047, 254965; left tibiotarsus, USNM 254062 (Fig. 35G); three right tarsometatarsi, USNM 254079, 254080, 254082; six left tarsometatarsi, USNM 254078 (Fig. 35H), 254081, 254083, 254085, 254086 (Fig. 35I), 254167.

*Measurements (mm) of paratypes:* Partial skeleton, USNM 254985: Mandible: length of tomial crest, 8.4; length of symphysis, 6.0. Femur: length, 14.5; proximal width, 3.0; mid-shaft depth, 1.2; distal width, 3.3. Tarsometatarsus: mid-shaft width, 1.1; distal width, 2.1.

For additional measurements of paratypes see Tables 12 and 13.

*Diagnosis:* The maxilla is similar to that of *Ciridops anna*, as is the mandible, with the following exceptions: the retroarticular process is longer, resembling a more upturned and somewhat shortened version of the retroarticular process in *Vestiaria coccinea*, the middle part of the ramus is not as deep, and the mandibular foramen is less enlarged. The femur, tibiotarsus, and tarsometatarsus are stouter than in *Himatione*, *Vestiaria*, *Palmeria*, or *Drepanis*, but not as stout as in *Ciridops anna*.

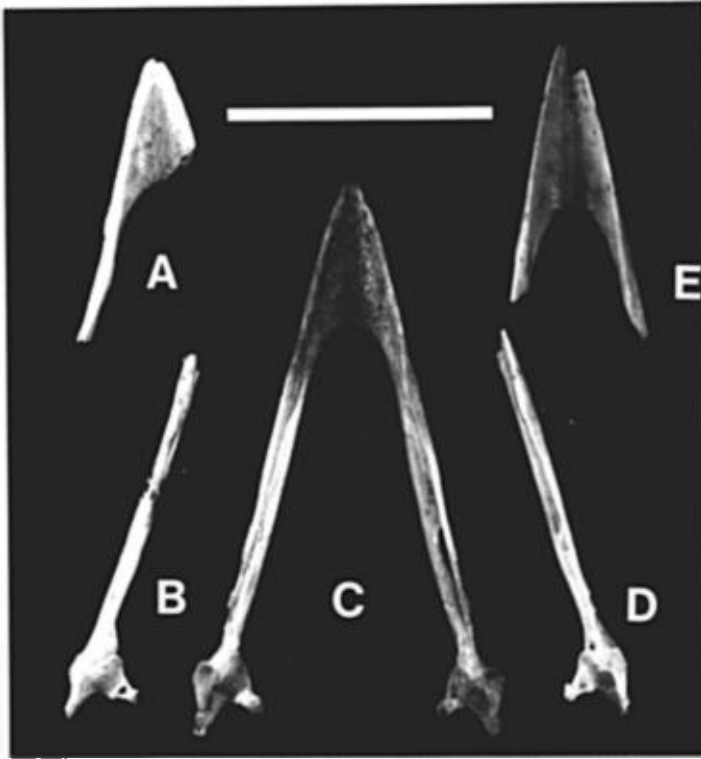

FIG. 33. Mandibles of *Ciridops* in dorsal view. *A*, *Ciridops* sp., Oahu (BBM-X 155172); *B*, *Ciridops* sp., Oahu (USNM 255292, part of retroarticular process missing); *C*, *C. anna* (MCZ 10995); *D*, *C. tenax*, new species (USNM 254969, part of retroarticular process missing); *E*, *C. tenax*, USNM 254157. Scale = 1 cm.

**Remarks:** In all of the characters mentioned in the diagnosis, *C. tenax* is intermediate between its more derived relative, *C. anna*, and the other taxa in Perkins' (1903) Division 1. Thus *C. tenax* stands out as the only new drepanidine species that we could interpret as a possible "missing link" between two distinct morphotypes.

Bones of the hindlimb of *C. tenax* are consistently smaller than in the specimens examined of *C. anna*, suggesting that *C. tenax* was a somewhat smaller bird overall (Table 13).

*Ciridops* sp., Oahu

(Figs. 31A, 32C, D, 33A, B, 34A, B, 35D, E, J, K)

"*Ciridops* sp., Oahu" Olson and James, 1982b:42, 45; 1984: 771.

"*Ciridops* sp." James, 1987:225.

**Material:** Maxilla lacking dorsal and left lateral nasal bars, BBM-X 155727 (Figs. 31A, 32C). Three damaged maxillae, USNM 255176, 255415 (Fig. 32D), 255179. Three mandibular symphyses, each with part of one ramus attached, USNM 255039, 255458, BBM-X 155172 (Fig. 33A). Two mandibular symphyses, USNM 255209, 255429. Left mandibular ramus without symphysis, USNM 255292 (Fig. 33B). Right femur, USNM 255124 (Fig. 35E). Left femur with



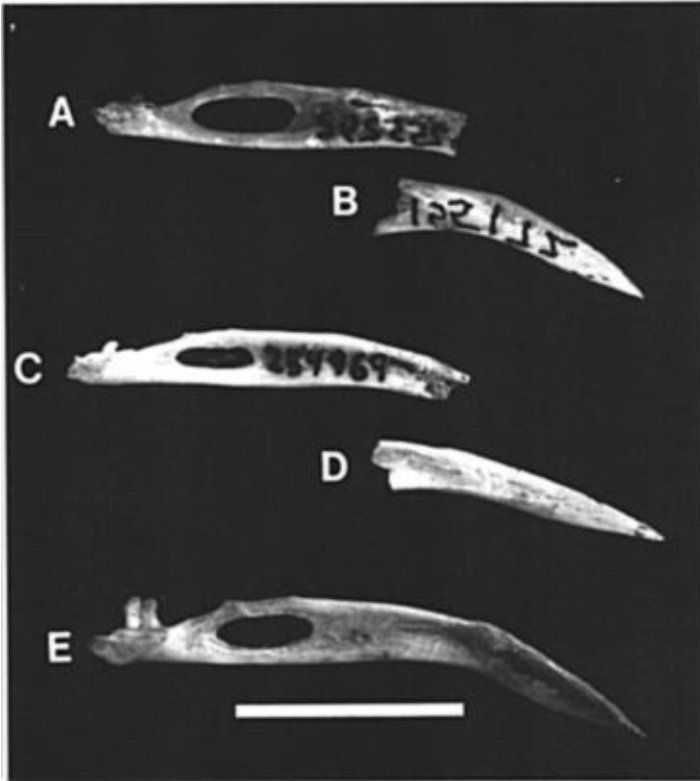

FIG. 34. Mandibles of *Ciridops* in lateral view. A, *Ciridops* sp., Oahu (USNM 255292; image is of the left side printed in reverse); B, *Ciridops* sp., Oahu (BBM-X 155172; image is of the left side printed in reverse); C, *C. tenax*, new species (USNM 254969); D, *C. tenax* (USNM 254157); E, *C. anna* (MCZ 10995). Scale = 1 cm.

damaged distal end, BBM-X 155669 (Fig. 35D). Right tarsometatarsus, USNM 255087 (Fig. 35K). Two left tarsometatarsi, USNM 255257, BBM-X 155689 (Fig. 35J).

*Distribution:* Oahu, Barbers Point.

*Measurements:* See Tables 12 and 13.

*Remarks:* Fossils of *Ciridops* from Oahu, which are encountered fairly frequently in the Barbers Point deposits, resemble *C. anna* in having the long bones of the hindlimb very stout, but differ in having the bill and the long bones slightly shorter (Tables 12 and 13, Figs. 32–34 and 35). With such meager comparative material of *C. anna* available, the importance of these differences is unclear. The Oahu bird is perhaps a distinct species, but for the present we have refrained from naming it.

## DISCUSSION

An updated conspectus of the fossil and historic distributions of resident passerine birds in the Hawaiian Islands appears in Table 14. Numerous extralimital distribution records for extant birds are not discussed in the text, including several previously unpublished records for Maui from our 1988 field season. These are



FIG. 35. Pelvic and hindlimb elements of *Ciridops*. A, pelvis of *C. tenax*, new species (USNM 445819); B, C, left femora of *C. tenax* (USNM 254045 and 254044); D, left and E, right femora of *Ciridops* sp., Oahu (BBM-X 155669 and USNM 255124); F, left tibiotarsus of *C. anna* (MCZ 10995); G, left tibiotarsus of *C. tenax* (USNM 254062); H, I, left tarsometatarsi of *C. tenax* (USNM 254078 and 254086); J, left and K, right tarsometatarsi of *Ciridops* sp., Oahu (BBM-X 155689 and USNM 255087); L, left tarsometatarsus of *C. anna* (MCZ 10995). Dorsal view of pelvis, posterior views of femora, anterior views of tibiotarsi and tarsometatarsi. Scale = 1 cm.

TABLE 14

FOSSIL AND HISTORICAL DISTRIBUTION OF ENDEMIC PASSERINE BIRDS IN THE HAWAIIAN ARCHIPELAGO. F, FOSSIL RECORD (INCLUDES ARCHAEOLOGICAL CONTEXTS). H, HISTORIC RECORD. LY, LAYSAN; N, NIHOA; K, KAUAI; O, OAHU; MO, MOLOKAI; LN, LANAI; MA, MAUI; H, HAWAII

	Ly	N	K	O	Mo	Ln	Ma	H
Family Corvidae								
<i>Corvus impluviatus</i>				F				
<i>Corvus viriosus</i>				F	F			
<i>Corvus</i> aff. <i>hawaiiensis</i>							F	F
<i>Corvus hawaiiensis</i>								H
Family Sylviidae								
<i>Acrocephalus familiaris</i>	H	H						
Family Myiagridae								
<i>Chasiempis sandwichensis</i>			FH	FH				FH
Family Muscicapidae								
<i>Myadestes palmeri</i>			FH					
<i>Myadestes myadestina</i>			FH					
<i>Myadestes lanaiensis</i>				FH	FH	H		
<i>Myadestes</i> sp., cf. <i>lanaiensis</i>							F	
<i>Myadestes obscurus</i>								FH
Family Meliphagidae								
<i>Moho braccatus</i>			FH					
<i>Moho apicalis</i>				FH				
<i>Moho bishopi</i>					FH			
<i>Moho</i> sp., Maui							F	
<i>Moho nobilis</i>								FH
<i>Chaetoptila</i> aff. <i>angustipluma</i>				F			F	
cf. <i>Chaetoptila</i> , narrow-billed sp.							F	
<i>Chaetoptila angustipluma</i>								FH
Family Fringillidae, Tribe Drepanidini								
<i>Telespiza cantans</i>	H			F	F			
<i>Telespiza ultima</i>		H			F			
<i>Telespiza persecutrix</i>			F	F				
<i>Telespiza ypsilon</i>					F		F	
<i>Telespiza</i> aff. <i>ypsilon</i> , Maui							F	
<i>Loxioides bailleui</i>				F				H
<i>Chloridops</i> sp., Kauai			F					
<i>Chloridops wahi</i>				F			F	
<i>Chloridops</i> sp., Maui							F	
<i>Chloridops kona</i>								H
<i>Chloridops regiskongi</i>				F				
<i>Rhodacanthis</i> aff. <i>flaviceps</i>				F			F	
<i>Rhodacanthis</i> aff. <i>palmeri</i>							F	
<i>Rhodacanthis flaviceps</i>								H
<i>Rhodacanthis palmeri</i>								H
<i>Orthospiza howarthi</i>							F	
<i>Xestospiza conica</i>			F					
<i>Xestospiza fastigialis</i>				F	F		F	
<i>Melamprosops phaeosoma</i>							FH	
<i>Psittirostra psittacea</i>			FH	FH	H	H	H	H
Various unidentified finches			F	F			F	
<i>Dysmorodrepanis munroi</i>						H		
<i>Pseudonestor xanthophrys</i>					F		FH	
<i>Hemignathus lucidus</i>			H	FH	F		FH	H
<i>Hemignathus wilsoni</i>								H
<i>Hemignathus stejnegeri</i>			FH					
<i>Hemignathus lichtensteini</i>				H				
<i>Hemignathus</i> sp., cf. <i>lanaiensis</i>					F		F	
<i>Hemignathus lanaiensis</i>						H		

TABLE 14  
CONTINUED

	Ly	N	K	O	Mo	Ln	Ma	H
<i>Hemignathus obscurus</i>								FH
<i>Hemignathus upuipirostris</i>			F	F				
<i>Oreomystis bairdi</i>			FH					
<i>Paroreomyza maculata</i>				FH				
<i>Paroreomyza montana</i>					FH	H	FH	
<i>Paroreomyza flammea</i>					H			
<i>Vangulifer mirandus</i>							F	
<i>Vangulifer neophasis</i>							F	
<i>Aidemia chascax</i>				F				
<i>Aidemia zanclops</i>				F				
<i>Aidemia lutetiae</i>					F		F	
<i>Loxops caeruleirostris</i>			H					
<i>Loxops coccineus</i>				H			H	H
<i>Loxops mana</i>								H
<i>Loxops parvus</i>			FH					
<i>Loxops stejnegeri</i>			FH					
<i>Loxops virens</i>				FH	H	H	H	FH
<i>Loxops sagittirostris</i>								H
<i>Vestiaria coccinea</i>			H	FH	H	H	FH	FH
<i>Drepanis funerea</i>					H		F	
<i>Drepanis pacifica</i>								H
<i>Himatione sanguinea</i>			H	FH	H	H	FH	FH
<i>Himatione sp., cf. sanguinea</i>			F		F			
<i>Palmeria dolei</i>					H		FH	
<i>Ciridops tenax</i>			F					
<i>Ciridops sp., Oahu</i>				F				
<i>Ciridops cf. anna</i>					F			
<i>Ciridops anna</i>								H

*Moho* sp. (a meliphagid), *Hemignathus* cf. *lanaiensis* (an akialoa), and *Drepanis funerea* (Black Mamo). Further documentation of these records will be published elsewhere.

All of the passerine fossils we have examined can be attributed to one of the five families that are known historically from the main islands (Corvidae, Myiagridae, Muscicapidae, Meliphagidae, and Fringillidae), thus revealing no previously unknown colonizations of the archipelago. This is in strong contrast to the non-passerine fossils, which include representatives of 8 to 10 previously unknown extinct lineages (Olson and James 1991). The colonizing species that gave rise to these lineages would have included a petrel (*Pterodroma*), an ibis (*Apteribis*), a duck or shelduck (moa-nalos), up to three geese of unknown affinities (*Geochen*, supernumerary Oahu goose, very large Hawaii goose), a large crane (*Porzana*), an eagle (*Haliaeetus*), a harrier (*Circus*), and a strigid owl (*Grallistrix*) (Olson and James 1991).

The fossil record extends the distribution of *Corvus* westward from the island of Hawaii to include Maui, Molokai, and Oahu. There is no reason to doubt that crows once occurred on all of the main islands. The two new species, *C. impluviatus* and *C. viriosus*, have been identified only from fossil sites in dry, lowland settings, whereas the fossils from higher elevation sites on Maui and Hawaii, while not positively identified, may not differ from the extant Hawaiian Crow, *Corvus hawaiiensis*.

A much more complete picture of the breadth of adaptive radiation in the Drepanidini has emerged through the fossil record. Extinction took its heaviest toll among the finch-billed taxa, which account for half of the new species described. Six other new species had diverse bill shapes that were probably mainly adapted for insectivory, including two meadowlark-like gapers, two sickle-bills, and two with broad, blunt bills. Only one of the new species belongs with the red-and-black, primarily nectarivorous species (Division 1 of Perkins [1903]), so that the predominance of nectarivory in the historically-known radiation is evidently an artifact of differential extinction.

Other extinctions were also non-random, removing all of the flightless and raptorial species everywhere except on the island of Hawaii. (We exclude *Asio flammeus*, which is not endemic and probably did not colonize the islands until after the arrival of humans [Olson and James 1982b]). Looking at passerines alone, we see that a wide distribution within the archipelago was no guarantee against extinction: 7 of the 16 new species (44%) are known from more than one island. Forest passerines that feed on nectar and insects seem to have been the best survivors.

We have examined almost all skin, skeleton, and alcoholic specimens of Hawaiian birds in Europe, North America, and Hawaii, and have not detected any overlooked specimens of the species we have described from fossils. Nevertheless, some of the extinct species described here may have survived in small numbers into the early part of the historic period (i.e., between the first western contact in 1778 and the first systematic ornithological collecting, beginning in the 1880's).

Although it may be unrealistic to expect to be able to identify specific causes of extinction for individual species (Diamond 1984), the chronological data linking rapid disappearance of a major portion of the Hawaiian avifauna with prehistoric human settlement is convincing. Factors that probably played a role in avian extinctions are habitat destruction, particularly of lowland forests, predation by humans and introduced mammals, and possibly unidentified introduced diseases (Olson and James 1982b, 1984, 1991). In considering the passerines by themselves, it seems unlikely that human predation was a primary cause of extinction for most of the small forest species, although it may have played a larger role in the disappearance of crows. Nor were the particular mammalian predators that were introduced by the Polynesians (dogs, pigs, and the Pacific rat [*Rattus exulans*]) likely to have decimated tree nesting species. It is possible that some fraction of the extinct passerine species (for instance, those in the genus *Telespiza*) were vulnerable to prehistoric mammalian predation because of nesting on or near the ground. Barring the discovery of devastating prehistoric introduction of avian disease, habitat alteration remains the leading candidate for the primary cause of extinction of so many small passerine species.

The historically known avifauna of the Hawaiian Islands consists of 40 (lumping) to 55 (splitting) endemic species (Olson and James 1991), whereas 35 fossil species have now been diagnosed. While these fossil discoveries have improved our appreciation for the diversity of the prehuman avifauna of the islands, it is worth emphasizing that many more extinct species await description. We have refrained from formally naming 8 additional fossil forms of drepanidines, many of which will doubtless also prove to be new species, and there are a number of very fragmentary fossils, including the previously cited "Additional Kauai Finch"

(Olson and James 1982b), that we have deliberately omitted from discussion. Treatment of the Hawaiian fossils of Meliphagidae, of which there appear to be at least two new species present, is also deferred pending further study. In Part I (Olson and James 1991), we mention an additional 11 fossil forms that are potentially new species (an ibis, 5 anatids, and 5 rails). We can be certain there are more extinct species of which we have not collected even the first fragment, considering that the prehuman avifaunas of the islands of Niihau, Lanai, and Kahoolawe are essentially unknown, and there are major gaps in the record from the island of Hawaii.

Although further collecting and descriptive work are still needed, the introduction of these new taxa ought to enable Hawaiian avian paleontology to emerge from what has of necessity been a purely descriptive phase. More attention can be now be given to other stimulating lines of research, such as the chronology, causes, and ecological consequences of extinction, and patterns in evolution and biogeography.

#### ACKNOWLEDGMENTS

The following acknowledgments apply to both parts of this study. We reiterate our indebtedness to the legions who have so generously assisted us with this project, both in the museum and the field, many of whom have already been mentioned in our *Prodromus* (Olson and James 1982b). We cannot let any opportunity pass to thank again those who have repeatedly provided assistance and support in the islands: Joan Aidem, Allen Allison, Carla H. Kishinami, C. J. Ralph, Carol P. Ralph, and Alan Ziegler. The great effort contributed by the Department of Zoology of the Bernice P. Bishop Museum, Honolulu, in curating and lending the fossil bird material acquired through that institution is profoundly appreciated.

The greatest advances that have been made in our knowledge of Hawaiian fossil birds since the publication of our *Prodromus* have come from Maui. We owe a special debt of gratitude to R. Michael Severns for his indefatigable efforts in locating fossil deposits on that island and for many hard days of work assisting us in collecting. For access to the majority of fossil sites on Maui, and for many other considerations that have facilitated our excavations, we are greatly indebted to Pardee Erdman, owner of Ulupalakua Ranch, and to Ed O. Rice, ranch foreman.

In 1982 we were assisted on Maui by Joan Aidem, Tonnie L. C. Casey, Laura Johnson, Angela K. Kepler, Cameron B. Kepler, Patricia Lester, Ronald Lester, Dan Saunders, and R. Michael Severns. During our excavations on Maui in 1984 we enjoyed the expertise of Paul S. Martin, Patrick C. McCoy, and David S. Steadman. At that time we were also assisted (at times overwhelmed) by a multitude of volunteers, gathered largely by Angela K. Kepler and Cameron B. Kepler. We hope that we have not overlooked any of their names: Joan Aidem, Christina Berman, Lili Berman, John Bose, Phil Bose, Janet Butzine, Colin Cameron, Doug Cameron, Mary Cooke, Sam Cooke, Carmelle Crivellone, Bill Eichenlaub, Mary Evanson, Denny Fen, Ann Fielding, Betsy H. Gagné, Bob Hobdy, Heinz Hoben, Hugo Huntzinger, Glen James, Willie Lansford, George LeBouvier, Lloyd L. Loope, Jonathan Mann, Grigoria Marrero, Nancy Mawson, Julia Murphy, Patty Nakao, Bruce Perrin, Sandy Powers, Lisa Raymond, David Salemme, Les Skillings, Mele Skillings, R. Michael Severns, Linda Stumley, Howell Thomas, Connie

Uzunboylu, Curtis Walseth, Evelyn Walseth, Callyn D. Yorke. For part of the time during our prolonged excavations on Maui in 1988 we benefitted materially from the assistance of Thomas W. Stafford, Jr., in obtaining stratigraphic and radiometric data. For additional assistance in excavating, screening, removing bags of sediment, and other favors that facilitated our 1988 field work on Maui we thank: Joan Aidem, Sheldon Berman, Fern P. Duvall, II, Babs Faye, Pauline Fiene-Severns, Renate Gassman-Duvall, Robert C. Fleischer, Lawrence Harper, Francis G. Howarth, Sabine Jessel, Mr. and Mrs. Merton Kekiwi, Carla H. Kishinami, Patty Lester, Ron Lester, Arthur C. Medeiros, Jr., Stephen Pereira, Thane Pratt, Ricky Purdy, Mike Rose, Ken Schmitt, R. Michael Severns, Katherine C. Smith, Thomas Smith, Sharon Thodt, Laura Thompson, Chuck Whiteman, Charles Wyndham, Edie Wyndham, and Clement Young.

Collection of fossils on National Park Service land in the Kipahulu Valley, Maui, was made possible by: Legario Hanky Eharis, Anne Marie LaRosa, Terrance Lind, Lloyd L. Loope, Arthur C. Medeiros, Jr., Ron Nagata, and Donald Reeser.

We are most grateful for various forms of assistance in the paleontological exploration of the following islands: Kauai: Dave S. Boynton, Pauline Fiene-Severns, Reginald Gage, Sandy Gage, Hallet H. Hammatt, Mike Kido, William K. Kikuchi, R. Michael Severns. Oahu: Diane C. Drigot, Robert J. Hommon, Carla H. Kishinami, Terry Lopez, Col. Charles Robinson, Thomas W. Stafford, Jr., Alan Ziegler. Molokai: Joan Aidem, Henry Laws, George K. Linney, Lloyd L. Loope, Earl Neller, Gary Somers. Kahoolawe: Tom Hauptman, various staff of the United States Navy. Hawaii: Newell Bohnett, William Cuccaro, John Earle, Jon G. Giffin, Francis G. Howarth, Jim Lavoie, Kathleen Lavoie, Stephen Mountainspring, Monty Richards, Nelson Santos, J. Michael Scott, Fred D. Stone.

The museum aspects of this study would not have been possible without the loan of many valuable and extremely rare specimens, including study skins of extinct species from which we removed bones using the method described by Olson et al. (1987). The curators, technicians, and others who assisted us are identified here with the museum acronyms (see Materials and Methods): Wesley E. Lanyon and Lester L. Short (AMNH); Auckland University Geology Department (AU—specimens made available through a loan to P. R. Millener); P. J. K. Burton, Graham Cowles, and Ian Galbraith (BMNH); Allen Allison, Carla H. Kishinami, Robert Pyle, and Alan Ziegler (BPBM); Canterbury Museum (CMC—specimens made available through a loan to P. R. Millener); Marion Jenkinson (KU); Raymond A. Paynter, Jr. (MCZ); Victoria M. Dziadosz, Ned K. Johnson, and Barbara Stein (MVZ—NSF Grant BMS 7200102); Herbert Schifter (NHMW); Sandy Bartle and P. R. Millener (NMNZ); Pierce Brodkorb (PB); A. Karkhu and E. N. Kurochkin (PIN); Gerlof Mees (RMNH); Molly Benson and Hilary Potter (UMZC); J. Phillip Angle (USNM); B. Stephan (ZMB).

At the Smithsonian, we thank Frederick V. Grady, who for many years has assisted us in the preparation and sorting of Hawaiian fossil material. Mark Florence has worked patiently and diligently with us to catalog our immense fossil collections. Other assistance with collection management of fossils has come from Jonathan Becker, Susan M. Folkert, and a grant from the Women's Committee of the Smithsonian Institution. Monetary support for our research in the Hawaiian Islands has otherwise come almost entirely through various funds and programs of the Smithsonian Institution, in which connection we express our great appre-

ciation to David Challinor, Robert Hoffmann, and S. Dillon Ripley. Victor E. Krantz of the Smithsonian Institution's Department of Photographic Services has spent countless hours with us over the years photographing Hawaiian and other fossils, for which are deeply appreciative. All of the photographs in the present publication are his work. The drawings in Figures 1 and 2 are by Jaquin B. Schulz.

For checking the new names and their etymologies we are most grateful to George Steyskal, Department of Entomology, National Museum of Natural History, Smithsonian Institution. For reading the manuscript and making many valuable comments we are indebted to Jonathan Becker, Ned K. Johnson, Robert J. Raikow, David W. Steadman, and Alan C. Ziegler.

### SUMMARY

Along with the non-passerine birds described in Part I (Olson and James 1991), abundant fossils of passerines were collected in the Hawaiian Islands over the past fifteen years. We describe 4 new genera and 16 new species in the families Corvidae and Fringillidae, and mention, but refrain from describing, up to 8 additional new species. We do not treat the fossil records of Hawaiian thrushes (*Myadestes*), flycatchers (*Chasiempis*), or honeyeaters (Meliphagidae) in this paper. Distributions of the fossil and historically-known passerines in the Hawaiian Archipelago are summarized in Table 14.

The major collections of passerines are from Kauai, Oahu, Molokai, and Maui, with less significant collections, mainly from archaeological contexts, available from the island of Hawaii. The other islands have no relevant fossil record as yet. The different modes of deposition of passerine and non-passerine fossils are briefly discussed. An extinct genus of ornithophagous owl, *Grallistrix*, contributed importantly to the fossil record by concentrating passerine remains at its roosts.

The passerine fossil material described here dates to the Holocene (<10,000 years ago). Fossils that date to over 120,000 years ago are known from Late Pleistocene sediments at Ulupau Head on Oahu, but we have not made use of this material in describing new taxa.

We describe two new species of crows, both larger than the extant *Corvus hawaiiensis*. *C. impuviatus*, a new species with a high, arched bill, is known only from Oahu, while *C. viriosus*, a new species with a long, straight bill, occurs on both Oahu and Molokai.

Four new genera and 14 new species of Drepanidini (Fringillidae: Carduelinae) are introduced, 8 with finch-like bills and 6 with a variety of more derived bill forms.

Fossils of *Telespiza*, a genus of finches restricted in historic times to Laysan and Nihoa, are widespread in the main islands with up to three species occurring on a single island. *Telespiza persecutrix*, new species, is from Kauai and Oahu. *T. ypsilon*, new species, is from Molokai and Maui; and a very small specimen from Maui may represent yet another new species. *T. cantans* (Laysan Finch) and *T. ultima* (Nihoa Finch) also occur as fossils in the main islands.

*Chloridops kona* (Kona Finch) from the island of Hawaii is the only historically known member its genus, but fossils reveal a greater diversity and wider distribution for *Chloridops*. *C. wahi*, new species, is a smaller form from Oahu and Maui. A second, even more diminutive, species may be indicated on Maui. *Chlor-*



*idops* sp. from Kauai resembles *C. wahi* but may prove to be a distinct species. The impressive new species *C. regiskongi*, from Oahu, is distinctive for the large size of its bill. *Orthospiza howarthi*, new genus and species, is a finch known so far only from relatively high elevations on Mt. Haleakala, Maui. Apparently a resident of wetter forests, *O. howarthi* had unusually large narial openings for such a heavy-billed finch.

The species of *Xestospiza*, new genus, had finch-like bills with a straight rather than arched profile to the maxilla. *Xestospiza conica*, new species, is known only from Kauai, whereas *X. fastigialis*, new species, has the widest distribution of any new fossil form, being known so far from Oahu, Molokai, and Maui.

We postpone describing four finch-billed drepanidines either because the fossils available would be inadequate as types or because larger series of comparative skeletons are needed to evaluate variation. These include two possible new species of *Rhodacanthis* (koa finches), and two distinctive finches of unknown generic affinities, one each from Oahu and Maui.

Among the drepanidines that were not finch-like, *Hemignathus upupirostris*, new species, from Oahu and Kauai, is a sickle-billed species with a mandibular symphysis resembling that of hoopoes (Upupidae). *Vangulifer* is an enigmatic new genus from Maui, containing the new species *V. mirandus* and *V. neophasis*. These had rather long and weak bills that were remarkably broad anteriorly. What these birds may have fed on is a mystery.

*Aidemia* is a new genus of drepanidines adapted for gaping, of which we describe three new species, *A. lutetiae* from Molokai, *A. chascax* from Oahu, and *A. zanclops*, also from Oahu. The latter had a sickle-shaped bill while the first two had straight bills like those of meadowlarks (Icteridae: *Sturnella*).

Of the 5 genera in Perkin's (1903) Division 1, only *Ciridops* has a greater diversity in the fossil record. We name *C. tenax* as a new species from Kauai, and discuss, but defer naming, a form of *Ciridops* from Oahu. Fossils of *Ciridops* from Molokai may prove to be conspecific with *C. anna*, known historically from the island of Hawaii.

The extinction of so many species of Hawaiian passerines is attributed mainly to prehistoric human-wrought changes in forest habitats.

#### LITERATURE CITED

- AMADON, D. 1950. The Hawaiian honeycreepers (Aves, Drepaniidae). Bull. Amer. Mus. Nat. Hist. 95(4):151-262.
- AMERICAN ORNITHOLOGISTS' UNION 1983. Check-list of North American Birds, 6th ed. American Ornithologists' Union [Washington, D.C.].
- BAIRD, R. F. 1985. Avian fossils from Quaternary deposits in 'Green Waterhole Cave', southeastern South Australia. Rec. Austral. Mus. 37:353-370.
- BANKS, R. C., AND R. C. LAYBOURNE. 1977. Plumage sequence and taxonomy of Laysan and Nihoa Finches. Condor 79(3):343-348.
- BAUMEL, J. J., A. M. LUCAS, J. E. BREAZILE, AND H. E. EVANS, Eds. 1979. Nomina Anatomica Avium: An Annotated Anatomical Dictionary of Birds. Academic Press, London.
- BEECHER, W. J. 1951. Adaptations for food-getting in the American blackbirds. Auk 68(4):411-440.
- BENSON, B. 1977. Harbor sites yield rare fossils. Honolulu Star Bull. & Advertiser. [Beginning p. A3.] Sunday, 24 July.
- BERGER, A. J. 1981. Hawaiian Birdlife, 2nd ed. Univ. of Hawaii Press, Honolulu.
- BLEDISOE, A. H. 1988. Nuclear DNA evolution and phylogeny of the New World Nine-primaried Oscines. Auk 105(3):504-515.

- BOCK, W. J. 1960. The palatine process of the premaxilla in the Passeres. *Bull. Mus. Comp. Zool.* 122(8):361-488.
- BOWMAN, R. I. 1961. Morphological differentiation and adaptation in the Galapagos Finches. *Univ. Calif. Publ. Zool.* No. 58:vii + 326 pp.
- BRYAN, W. A. 1917. Description of *Telespiza ultima* from Nihoa Island. *Auk* 34(1):70-72.
- CARROLL, R. L. 1987. *Vetebrate Paleontology and Evolution*. W. H. Freeman and Co., New York.
- CASEY, T. L. C., AND J. D. JACOBI. 1974. A new genus and species of bird from the island of Maui, Hawaii (Passeriformes, Drepanididae). *Occ. Pap. Bishop Mus.* 24(12):215-226.
- DIAMOND, J. M. 1984. Historic extinctions: a rosetta stone for understanding prehistoric extinctions. Pp. 824-862 in *Quaternary Extinctions: A Prehistoric Revolution* (P. S. Martin and R. G. Klein, Eds.). Univ. Ariz. Press.
- HOWARD, H. 1929. The avifauna of Emeryville shellmound. *Univ. California Publ. Zool.* 32(2):301-394. [Illustrations reprinted (1980) in *Contrib. Sci. Natur. Hist. Mus. Los Angeles County* 330: xxvii-xxxviii.]
- JAMES, H. F. 1987. A Late Pleistocene avifauna from the island of Oahu, Hawaiian Islands. *Documents des Laboratoires de Géologie de la Faculté des Sciences de Lyon* 99:221-230.
- JAMES, H. F., T. W. STAFFORD, JR., D. W. STEADMAN, S. L. OLSON, P. S. MARTIN, A. J. T. JULL, AND P. C. MCCOY. 1987. Radiocarbon dates on bones of extinct birds from Hawaii. *Proc. National Acad. Sci. USA* 84:2350-2354.
- JAMES, H. F., R. L. ZUSI, AND S. L. OLSON. 1989. *Dysmorodrepanis munroi* (Fringillidae: Drepanidini), a valid genus and species of Hawaiian Finch. *Wilson Bull.* 101(2):159-179.
- JOHNSON, N. K., J. A. MARTEN, AND C. J. RALPH. 1989. Genetic evidence for the origin and relationships of Hawaiian honeycreepers (Aves: Fringillidae). *Condor* 91:379-396.
- MAYR, E., R. J. ANDREW, AND R. A. HINDE. 1956. Die systematische Stellung der Gattung *Fringilla*. *J. für Ornithol.* 97(3):258-273.
- OLSON, S. L. 1990a. Osteology and systematics of the fernbirds (*Bowdleria*: Sylviidae). *Notornis* 37(3 & 4):161-171.
- OLSON, S. L. 1990b. Comments on the osteology and systematics of the New Zealand passerines of the genus *Mohoua*. *Notornis* 37(3 & 4):157-160.
- OLSON, S. L., J. P. ANGLE, F. V. GRADY, AND H. F. JAMES. 1987. A technique for salvaging anatomical material from study skins of rare or extinct birds. *Auk* 104(3):510-512.
- OLSON, S. L., AND H. F. JAMES. 1982a. Fossil birds from the Hawaiian Islands: evidence for wholesale extinction by man before Western contact. *Science* 217(4560):633-635.
- OLSON, S. L., AND H. F. JAMES. 1982b. Prodrum of the fossil avifauna of the Hawaiian Islands. *Smithsonian Contr. Zool.* 365:1-59.
- OLSON, S. L., AND H. F. JAMES. 1984. The role of Polynesians in the extinction of the avifauna of the Hawaiian Islands. Pp. 768-780 in *Quaternary Extinctions: A Prehistoric Revolution* (P. S. Martin and R. G. Klein, Eds.). University of Arizona Press, Tucson.
- OLSON, S. L., AND H. F. JAMES. 1986. The holotype of the Laysan Finch *Telespiza cantans* Wilson (Passeriformes: Drepanidini). *Bull. Brit. Ornithol. Club* 106(2):84-86.
- OLSON, S. L., AND H. F. JAMES. 1988. Nomenclature of the Kauai Amakihi and Kauai Akialoa. *Elepaio* 84(2):13-14.
- OLSON, S. L., AND H. F. JAMES. 1991. Descriptions of 32 new species of birds from the Hawaiian Islands: Part 1, non-Passeriformes. *Ornith. Monogr.* 45:1-88.
- PÄÄBO, S. 1989. Ancient DNA: extraction, characterization, molecular cloning, and enzymatic amplification. *Proc. Natl. Acad. Sci. USA* 86:1939-1943.
- PERKINS, R. C. L. 1903. *Vertebrata. In Fauna Hawaiiensis or the Zoology of the Sandwich (Hawaiian) Islands, Vol. 1, Part 5* (D. Sharp, Ed.). Univ. Press, Cambridge.
- PERKINS, R. C. L. 1919. On a new genus and species of bird of the family Drepanididae from the Hawaiian Islands. *Ann. Mag. Nat. Hist., series 9*, 3(13):250-252.
- PRATT, H. D. 1979. A systematic analysis of the endemic avifauna of the Hawaiian Islands. Ph.D. dissertation. Louisiana State University, Baton Rouge, Louisiana.
- PRATT, H. D., P. L. BRUNER, AND D. G. BERRETT. 1987. *The Birds of Hawaii and the Tropical Pacific*. Princeton University Press, Princeton, New Jersey.
- PREGILL, G. K. 1981. Late Pleistocene herpetofaunas from Puerto Rico. *Univ. Kansas Misc. Publ.* 71:1-72.
- RAIKOW, R. J. 1976. Pelvic appendage myology of the Hawaiian honeycreepers (Drepanididae). *Auk* 93(4):471-474.

- RAIKOW, R. J. 1977. The origin and evolution of the Hawaiian honeycreepers (Drepanididae). *Living Bird* 15:95-117.
- RICHARDS, L. P., AND W. J. BOCK. 1973. Functional anatomy and adaptive evolution of the feeding apparatus in the Hawaiian honeycreeper genus *Loxops* (Drepanididae). *Ornithol. Monogr.* 15: 1-173.
- SIBLEY, C. G., AND J. E. AHLQUIST. 1982. The relationships of the Hawaiian honeycreepers (Drepaninini) [sic] as indicated by DNA-DNA hybridization. *Auk* 99(1):130-140.
- SUSHKIN, P. P. 1924. [Resumé of the taxonomical results of morphological studies of the Fringillidae.] *Bull. Brit. Ornithol. Club* 45:36-39.
- WETMORE, A. 1924. A warbler from Nihoa. *Condor* 26(5):177-178.
- WILKINSON, L. 1988. SYGRAPH. SYSTAT, Inc., Evanston, Illinois.
- WILKINSON, L. 1989. SYSTAT: The System for Statistics. SYSTAT, Inc., Evanston, Illinois.
- WILSON, S. B., AND A. H. EVANS. 1890-1899. *Aves Hawaiienses: The Birds of the Sandwich Islands*. R. H. Porter, London. [A facsimile reprint was issued in 1974 as part of the series "Natural Sciences in America" by Arno Press, New York.]
- ZISWILER, V. 1965. Zur Kenntnis des Samenöffnens und der Struktur des hörnernten Gaumens bei körnerfressenden Oscines. *J. Ornithol.* 106(1):1-48.
- ZUSI, R. L. 1978. The interorbital septum in cardueline finches. *Bull. Brit. Ornithol. Club* 98(1): 5-10.
- ZUSI, R. L. 1987. A feeding adaptation of the jaw articulation in new world jays (Corvidae). *Auk* 104(4):665-680.

## ORNITHOLOGICAL MONOGRAPHS

- No. 1. *A Distributional Study of the Birds of British Honduras*. Stephen M. Russell. 1964. (Out of print)
- No. 2. *A Comparative Study of Some Social Communication Patterns in the Pelecaniformes*. G. F. van Tets. 1965. \$2.50.
- No. 3. *The Birds of Kentucky*. R. M. Mengel. 1965. \$10.00.
- No. 4. *Evolution of Some Arctic Gulls (Larus): an Experimental Study of Isolating Mechanisms*. Neal G. Smith. 1966. (Out of print)
- No. 5. *A Comparative Life-history Study of Four Species of Woodpeckers*. Louise de Kiriline Lawrence. 1967. (Out of print)
- No. 6. *Adaptations for Locomotion and Feeding in the Anhinga and the Double-crested Cormorant*. O. T. Owre. 1967. \$3.00.
- No. 7. *A Distributional Survey of the Birds of Honduras*. B. L. Monroe, Jr. 1968. \$7.00.
- No. 8. *An Approach to the Study of Ecological Relationships among Grassland Birds*. John A. Wiens. 1969. (Out of print)
- No. 9. *Mating Systems, Sexual Dimorphism, and the Role of Male North American Passerine Birds in the Nesting Cycle*. Jared Verner and Mary F. Willson. 1969. (Out of print)
- No. 10. *The Behavior of Spotted Antbirds*. E. O. Willis. 1972. \$4.00.
- No. 11. *Behavior, Mimetic Songs and Song Dialects, and Relationships of the Parasitic Indigobirds (Vidua) of Africa*. R. B. Payne. 1973. \$6.00.
- No. 12. *Intra-island Variation in the Mascarene White-eye Zosterops borbonica*. F. B. Gill. 1973. \$2.50.
- No. 13. *Evolutionary Trends in the Neotropical Ovenbirds and Woodhewers*. A. Feduccia. 1973. \$2.50.
- No. 14. *A Symposium on the House Sparrow (Passer domesticus) and European Tree Sparrow (P. montanus) in North America*. S. C. Kendeigh, Ed. 1973. \$3.00.
- No. 15. *Functional Anatomy and Adaptive Evolution of the Feeding Apparatus in the Hawaiian Honeycreeper Genus Loxops (Drepanididae)*. L. P. Richards and W. J. Bock. 1973. \$5.00.
- No. 16. *The Red-tailed Tropicbird on Kure Atoll*. R. R. Fleet. 1974. \$3.00.
- No. 17. *Comparative Behavior of the American Avocet and the Black-necked Stilt (Recurvirostridae)*. R. B. Hamilton. 1975. \$4.00.
- No. 18. *Breeding Biology and Behavior of the Oldsquaw (Clangula hyemalis L.)*. R. M. Alison. 1975. \$2.50.
- No. 19. *Bird Populations of Aspen Forests in Western North America*. J. A. D. Flack. 1976. \$4.00.
- No. 20. *Sexual Size Dimorphism in Hawks and Owls of North America*. N. F. R. Snyder and J. W. Wiley. 1976. \$6.00.
- No. 21. *Social Organization and Behavior of the Acorn Woodpecker in Central Coastal California*. M. H. MacRoberts and B. R. MacRoberts. 1976. \$4.00.
- No. 22. *Maintenance Behavior and Communication in the Brown Pelican*. R. W. Schreiber. 1977. \$3.50.
- No. 23. *Species Relationships in the Avian Genus Aimophila*. L. L. Wolf. 1977. \$7.00.
- No. 24. *Land Bird Communities of Grand Bahama Island: The Structure and Dynamics of an Avifauna*. J. T. Emlen. 1977. \$5.00.
- No. 25. *Systematics of Smaller Asian Night Birds Based on Voice*. J. T. Marshall. 1978. \$4.00.
- No. 26. *Ecology and Behavior of the Prairie Warbler Dendroica discolor*. V. Nolan, Jr. 1978. \$15.00.
- No. 27. *Ecology and Evolution of Lek Mating Behavior in the Long-tailed Hermit Hummingbird*. F. G. Stiles and L. L. Wolf. 1979. \$4.50.
- No. 28. *The Foraging Behavior of Mountain Bluebirds with Emphasis on Sexual Foraging Differences*. H. W. Power. 1980. \$4.50.
- No. 29. *The Molt of Scrub Jays and Blue Jays in Florida*. G. T. Bancroft and G. E. Woolfenden. 1982. \$4.00.
- No. 30. *Avian Incubation: Egg Temperature, Nest Humidity, and Behavioral Thermoregulation in a Hot Environment*. G. S. Grant. 1982. \$5.00.
- No. 31. *The Native Forest Birds of Guam*. J. M. Jenkins. 1983. \$6.00.
- No. 32. *The Marine Ecology of Birds in the Ross Sea, Antarctica*. D. G. Ainley, E. F. O'Connor, and R. J. Boekelheide. x + 97 pp. 1984. \$9.00 (\$8.00).
- No. 33. *Sexual Selection, Lek and Arena Behavior, and Sexual Size Dimorphism in Birds*. R. B. Payne. viii + 52 pp. 1984. \$8.00 (\$6.50).
- No. 34. *Pattern, Mechanism, and Adaptive Significance of Territoriality in Herring Gulls (Larus argentatus)*. J. Burger. xii + 92 pp. 1984. \$9.00 (\$7.00).
- No. 35. *Ecogeographical Variation in Size and Proportions of Song Sparrows (Melospiza melodia)*. J. W. Aldrich. x + 134 pp. 1984. \$10.50 (\$8.50).
- No. 36. *Neotropical Ornithology*. P. A. Buckley et al., Eds. xi + 1,041 pp., 8 color plates. 1985. \$70.00.
- No. 37. *Avian Monogamy*. P. A. Gowaty and D. W. Mock, Eds. vi + 121 pp. 1985. \$11.00 (\$9.00).
- No. 38. *An Analysis of Physical, Physiological, and Optical Aspects of Avian Coloration with Emphasis on Wood-Warblers*. E. H. Burt, Jr. x + 122 pp. 1986. \$15.00 (\$12.50).
- No. 39. *The Lingual Apparatus of the African Grey Parrot, Psittacus erithacus Linné (Aves: Psittacidae): Description and Theoretical Mechanical Analysis*. D. G. Homberger. xii + 236 pp. 1986. \$25.00 (\$20.00).
- No. 40. *Patterns and Evolutionary Significance of Geographic Variation in the Schistacea Group of the Fox Sparrow (Passerella iliaca)*. R. M. Zink. viii + 119 pp. 1986. \$15.00 (\$12.50).
- No. 41. *Hindlimb Myology and Evolution of the Old World Suboscine Passerine Birds (Acanthistidae, Pittidae, Philepittidae, Eurylaimidae)*. Robert J. Raikow. viii + 81 pp. 1987. \$12.50 (\$9.50).
- No. 42. *Speciation and Geographic Variation in Black-tailed Gnatcatchers*. Jonathan L. Atwood. vii + 74 pp. 1988. \$10.00 (\$8.00).
- No. 43. *A Distributional Survey of the Birds of the Mexican State of Oaxaca*. Laurence C. Binford. viii + 418 pp. 1989. \$40.00 (\$36.00).
- No. 44. *Recent Advances in the Study of Neogene Fossil Birds*. K. Jeffrey Bickart and Robert M. Chandler. vi + 161 pp. 1990. \$19.75 (\$17.75).

Order from: Max C. Thompson, Assistant to the Treasurer A.O.U., Department of Biology, Southwestern College, 100 College Street, Winfield, KS 67156. Orders must be prepaid, in U.S. dollars; add 5 percent (minimum \$2.00) handling and shipping charge. Make checks payable to American Ornithologists' Union. Prices in parentheses are for A.O.U. members.