

ADAPTATIONS FOR
LOCOMOTION AND FEEDING
IN THE ANHINGA AND THE
DOUBLE-CRESTED CORMORANT

BY
OSCAR T. OWRE

ORNITHOLOGICAL MONOGRAPHS NO. 6
PUBLISHED BY
THE AMERICAN ORNITHOLOGISTS' UNION

ORNITHOLOGICAL MONOGRAPHS

This series, published by the American Ornithologists' Union, has been established for major papers too long for inclusion in the Union's journal, *The Auk*. Publication has been made possible through the generosity of Mrs. Carll Tucker and the Marcia Brady Tucker Foundation, Inc.

Correspondence concerning manuscripts for publication in the series should be addressed to the Editor, Dr. Robert W. Storer, Museum of Zoology, The University of Michigan, Ann Arbor, Michigan 48104.

Copies of *Ornithological Monographs* may be ordered from the Treasurer of the AOU, Burt L. Monroe, Sr., Box 23447, Anchorage, Kentucky 40223. (See price list on inside back cover.)

Ornithological Monographs, No. 6, 138 pp.

Associate Editor: Richard L. Zusi

Assistant Editors: Joseph R. Jehl, Jr., and Jeanne D. Jehl

Issued October 5, 1967

Price \$3.50 prepaid (\$2.80 to AOU members)

Library of Congress Catalogue Card Number 67-30457

Printed by The Allen Press Inc., Lawrence, Kansas 66044

ADAPTATIONS FOR
LOCOMOTION AND FEEDING
IN THE ANHINGA AND THE
DOUBLE-CRESTED CORMORANT

BY
OSCAR T. OWRE

ORNITHOLOGICAL MONOGRAPHS NO. 6
PUBLISHED BY
THE AMERICAN ORNITHOLOGISTS' UNION

CONTENTS

	Page
ACKNOWLEDGMENTS	4
INTRODUCTION	5
Materials and methods	6
AERODYNAMICS AND THE WING	7
Flight characteristics	7
Weight and wing loading	7
Main elements of the wing skeleton	9
The carpometacarpus and the digits	10
The pectoral girdle	11
Pneumaticity	13
Myology of the wing	13
Discussion	38
Conclusions	46
THE TAIL	48
Size, functions, and molt	48
Osteology of the tail	51
Muscles of the tail	54
Summary and conclusions	59
THE LEG	60
Swimming	60
Osteology of the pelvis and leg	63
The pelvis	63
The femur	65
The tibiotarsus and fibula	65
The patella	66
The tarsometatarsus	68
Metatarsal I	69
The digits	69
Myology of the leg	72
Discussion and summary	99
Conclusions	104
THE HEAD	106
Method of feeding	106
The skull	107
Certain muscles of the skull and jaws	110
Discussion	121
The muscles of the neck attaching to the skull	121
Jaw action	123
Adduction of the lower jaw	123
Abduction of the lower jaw	126
Action of the upper jaw: abduction	126
Action of the upper jaw: adduction	126
Phylogenetic implications of comparisons of the skull, jaws, and associated muscles	127
FOOD	129
Summary	133
CONCLUSIONS: THE ANHINGA AND THE PHALACROCORACIDAE	134
LITERATURE CITED	136

ACKNOWLEDGMENTS

Inspiration for this investigation was derived from course work and conversation with the late Dr. Josselyn Van Tyne and Dr. Robert W. Storer. Dr. Van Tyne directed the study into its middle phases. I am greatly indebted to Dr. Storer for his counsel and direction during the remaining portion of my work.

I wish to thank Dr. Andrew J. Berger, then of the Department of Anatomy of The University of Michigan, for his helpful criticisms of the section dealing with the myology of the wing. Dr. Richard Robins and Mr. Luis R. Rivas of the University of Miami confirmed identification of certain fish. I am obliged to Mr. Dennis Paulson for the collection of an Anhinga and a cormorant. Mr. Arthur P. Kirk of Goodland, Florida, provided much useful information, gained from his long experience in the mangrove areas of the State.

I am grateful to The University of Michigan and to the University of Miami for facilities extended to me. The Florida Game and Fresh Water Fish Commission granted me special permission to collect in certain restricted areas, and Mr. Daniel S. Beard as Superintendent of the Everglades National Park offered me privileges which facilitated my observations.

Without the inspiration and assistance of Harding B. Owre this investigation might never have been brought to completion.

INTRODUCTION

Few contributions to our knowledge of the ecology of the Anhinga, *Anhinga anhinga leucogaster* (Vieillot), have been made since the observations of Audubon (1838: 136-160). The most important of these is the work of Meanley (1954). Current summarizations of life history material are drawn largely from Audubon's observations.

Certain aspects of the anatomy of *Anhinga* received considerable investigation in the years preceding 1900 and, to some extent, shortly after that. The osteology and myology of the neck were dealt with by Garrod (1876a: 334-340), Forbes (1882: 210-212), Beddard (1898: 413-415), Virchow (1917), and Boas (1929). General reviews of the osteology were made by Mivart (1879) and Shufeldt (1902). Morphology of the alimentary tract was described in Audubon (1838), by Forbes (1882: 208-210), Cazin (1884), Garrod (1876a: 341-345; 1878: 679-681), Beddard (1892: 292-295), and others. Chandler (1916: 307-311) compared features of the ptilosis in *Anhinga* and *Phalacrocorax*. With the exception of the cervical muscles, detailed considerations of the myology are lacking. Little attempt has been made to relate the morphology of the Anhinga to function and to the ecology of the species.

The Double-crested Cormorant, *Phalacrocorax auritus* (Lesson), is more widely distributed in North America than the Anhinga. Both are fish-eating birds, but perhaps because of its more extensive distribution in North America, only the cormorant has been the subject of economic consideration. Lewis (1929) and Mendall (1936) are among those who have contributed to knowledge of its natural history. The osteology and myology of *Phalacrocorax* have been investigated by Mivart (1879), Shufeldt (1902), Boas (1929), and others. Hofer (1950) described the jaw musculature of many Steganapodes, *P. carbo* in particular, and also made references to *Anhinga*.

There has been no satisfactory agreement on the taxonomic relationship between *Anhinga* and *Phalacrocorax*. Sharpe (1891: 77) considered the two genera as belonging to separate subfamilies of the Phalacrocoraces, while Peters (1931: 85, 94) and Wetmore (1951: 15) placed them in separate families. Wetmore (1951: 4) stated "they differ in such degree that they should be retained in separate family status." According to Mayr and Amadon (1951: 5-6), "*Anhinga* is so much like *Phalacrocorax* that it would seem to require no more than subfamily status." Comparisons of the anatomy of representatives of the two genera would be of value in determining the degree of their relationship.

Both the Anhinga and the southern race of the Double-crested Cormorant, *Phalacrocorax auritus floridanus* (Audubon), are permanent residents in south Florida. Their habitats are in close proximity and in some situations overlap. The cormorant is predominantly a bird of the marine littoral, but it is found in the larger and the more open bodies of fresh water as well. Although some Anhingas may nest in the mangrove swamps of the marine littoral, these birds fish to a large extent in fresh water. Anhingas are most frequently found in the small ponds of the cypress swamps and willow-heads and in the larger fresh-water bodies of the peninsula. Both species secure their food while under water. Analyses of stomach contents indicate

that, in situations where both fish the same waters, a degree of competition for the available food supply may exist. (See page 133.)

This investigation is a contribution to knowledge of the ecology and anatomy of the Anhinga and the southern race of the Double-crested Cormorant, hereinafter referred to as the "cormorant." Features of the anatomy of the two species are compared and discussed in relation to function and ecology. Differences in the two species which might be important in taxonomic consideration are discussed.

Materials and Methods.—For purposes of the investigation 17 Anhingas and 12 cormorants were collected in South Florida. All of these but one of each species were collected by me. The specimens were used for dissection, skeletal preparation, and study skins.

During the first two years of the investigation, I estimated that I spent in excess of 500 hours in actual observation of Anhingas and cormorants (chiefly the former) in the field. Considerable time has been spent in observation since then.

Procedures used in dissection, measurement, etc. are described in the sections dealing with major portions of the anatomy.

AERODYNAMICS AND THE WING

Flight Characteristics.—The Anhinga and the cormorant are readily distinguished in flight. The flight of the cormorant is marked by uninterrupted flapping, while the Anhinga “sets its wings and scales at intervals, when it suggests . . . the flight of a Cooper’s Hawk” (Bent, 1922: 234). The soaring ability of the Anhinga is well known; while circling in thermals of rising air, often in company with other species, it may rise to considerable heights. Varied aerial maneuvers may be a part of courtship. Soaring flight is apparently unusual in the cormorant. Maneuvers by cormorants on the wing are not known to take place during courtship.

The Anhinga usually becomes air-borne by diving into flight from trees, bushes, rocks, or banks. Take-off from the water is, according to my observations, an unusual occurrence. The Anhinga usually leaves the water by crawling out onto emergent growth, banks, etc.

The cormorant becomes air-borne after a long running take-off from the water’s surface or by diving into flight from exposed positions to which it has flown previously. On the ocean and on the larger bodies of fresh water, it must be materially aided in take-off by the lift it acquires when facing into the wind, which in such places is usually present.

With reference to anatomy to be discussed, comparison may be made of the habitats of the two species. The Anhinga usually dives into flight from elevated perches. However, many of the fresh-water areas it frequents in south Florida are margined by high walls of cypress trees and other growth, and, where the opening afforded by the pond is small, the bird must gain altitude rapidly in order to climb over the wall of vegetation or it must maneuver in flight through the growth. Such vegetation effectively cuts off the wind. The Cormorant apparently does not frequent waters that lack adequate space for a running take-off and that are shielded from surface winds.

Landings from flight by the Anhinga are almost invariably made on exposed, elevated perches. On several occasions, however, I also observed full-stall landings on the water’s surface. The bird appeared to drop into the water on its belly and breast; it did not continue forward momentum. Such landings were always made after a short flight from a nearby perch.

In the cormorant, the stall before landing does not seem to be as complete as that observed in the Anhinga. The cormorant slides onto the water in a relatively long, coasting belly-landing. Landings upon exposed perches are made as in the Anhinga. Again, the cormorant is probably aided in landing by the lift it receives from the winds which usually prevail in its relatively less-sheltered habitat.

A discussion of aerodynamics should include mention of the type of molt. Aningas apparently shed the remiges simultaneously and remain flightless for a period. There is no indication that this is the case with cormorants; in fact, all evidence is to the contrary (page 50). These birds, then, must compensate in flight for any pairs or groups of remiges which may be in molt.

Weight and Wing Loading.—Fresh weights of 16 Aningas and 11 Cormorants were obtained (Table 1). Birds were weighed a short time after death, in many cases within a few minutes after being retrieved.

TABLE 1
WEIGHTS (IN GRAMS) OF ANHINGAS AND CORMORANTS FROM SOUTH FLORIDA

Species	Sex	Number	Extremes	Mean
Anhinga	male	9	1,129-1,389	1,245
Anhinga	female	7	1,057-1,420	1,174
Cormorant	male	6	1,327-2,079	1,758
Cormorant	female	5	1,391-1,665	1,535

The greater weight of the cormorant is evident. In both species males are probably heavier than females. The difference in weight between sexes is, according to "t" values as they are customarily defined (Richardson, 1944: 446), possibly, but not certainly significant. Only rough estimates of variance are possible in such small samples, however.

Measurements of wing span compared with wing width are frequently regarded as indicative of aerodynamic potentiality. Wings are not of uniform width from base to tip, hence the so-called "aspect ratio" is, from certain standpoints, rather unsatisfactory. More useful here is the measurement of the total surface area of the wings, from which wing loading can be computed.

The total surface area of the wings of eight Anhingas and eight cormorants (four males and four females of each) was measured. The body and outstretched wings of freshly-killed specimens were positioned against paper and an outline of the entire bird was drawn. In a procedure similar to that described by Poole (1938: 511), a compensating polar planimeter was used to find the area of the total surface of the wings. Included in this measurement was the area between the spread ends of the slotted primaries. Surface area was measured with the bastard wing not extended. Measurements of wing loading are given in Table 2.

Sexual dimorphism in wing loading may be significant in the Anhinga, but the samples are too small to prove this. Differences in wing loading between the two species are clearly significant. The average wing loading of eight Anhingas of both sexes was found to be 0.76 grams per square centimeter of wing surface; in the cormorant it was 1.04 grams per square centimeter. No overlap was found between the species in this character. Measurement of wing loading, therefore, provides a basis for comparison between the Anhinga and the cormorant.

TABLE 2
WING AREA AND WING LOADING IN THE ANHINGA AND THE CORMORANT

Species	Sex	Number	Surface Area of Both Wings in Square Centimeters		Wing Loading in Grams Per Square Centimeter	
			Extremes	Mean	Extremes	Mean
Anhinga	male	4	1,357-1,518	1,450	0.82-0.86	0.84
Anhinga	female	4	1,342-1,753	1,579	0.67-0.83	0.74
Cormorant	male	4	1,550-1,849	1,663	0.99-1.12	1.08
Cormorant	female	4	1,379-1,694	1,500	0.97-1.07	1.00

TABLE 3
MEASUREMENTS OF WING BONES OF THE ANHINGA AND THE CORMORANT¹

	Anhinga		Cormorant	
	Extremes	Mean	Extremes	Mean
Humerus				
Length in millimeters	121.0-128.3	124.4	130.4-158.3	140.5
Length as percentage of total length of wing skeleton	37.8- 38.5	38.2	36.2- 37.0	36.5
Length divided by the cube root of body weight	11.0- 12.3	11.7	11.1- 12.5	11.8
Ulna				
Length in millimeters	109.1-116.7	111.4	136.9-166.9	147.1
Length as percentage of total length of wing skeleton	34.1- 34.4	34.2	37.8- 38.7	38.3
Length divided by the cube root of body weight	9.8- 11.2	10.5	11.7- 13.1	12.3
Carpometacarpus plus Phalanx I, digit III				
Length in millimeters	88.6- 93.9	90.5	92.1-108.4	96.4
Length as percentage of total length of wing skeleton	27.2- 27.9	27.4	24.8- 25.8	25.1
Length divided by the cube root of body weight	7.9- 9.1	8.4	7.9- 8.5	8.0

¹ Based on 3 males and 3 females of each species.

Main Elements of the Wing Skeleton.—With reference to the segments of the wing, Engels (1941: 62) stated that “a few specimens, even single specimens, will suffice to reveal strongly contrasting patterns of proportions.” Measurements of wing bones of six specimens (three males, three females) each of the Anhinga and the cormorant are summarized in Table 3. These measurements are also expressed as percentages of the total length of the wing skeleton and of the cube root of body weight. The latter value (see Amadon, 1943: 172) was selected in lieu of a satisfactory axial measurement which might be used as an index for purposes of comparison, inasmuch as skulls, cervical vertebrae, and synsacra have undergone considerable adaptive modification in both species.

It will be seen from Table 3 that in the cormorant the ulna not only comprises a larger proportion of length of the wing skeleton, but, in proportion to the cube root of body weight, it is significantly longer than is the Anhinga's. Proportions of the wing elements (Fig. 18) may be expressed in such form as Engels (1941: 65) employed.

Anhinga: humerus > ulna > carpometacarpus + phalanx 1, digit III.

Cormorant: humerus < ulna > carpometacarpus + phalanx 1, digit III.

The combined lengths of the wing bones of the two species are quite different. In three males and three females of the Anhinga, this value ranged from 321.0 to 338.9 millimeters (mean 325.7), and in the cormorant, 368.9 to 433.6 (mean 384.0). The total average length of the wing skeleton in the Anhinga was 88.5 per cent of that length in the cormorant.

The average wing span in the two species show little difference (Fig. 18), that of the Anhinga being only slightly shorter than that of the cormorant.

TABLE 4
WING LENGTH (ARC) OF ANHINGAS AND CORMORANTS (IN MILLIMETERS)

Species	Sex	Number	Extremes	Mean
Anhinga	male	10	318-351	334.5
Anhinga	female	7	292-332	319.8
Cormorant	male	5	297-317	304.2
Cormorant	female	6	282-296	291.0

TABLE 5
MEASUREMENTS (IN MILLIMETERS) OF THE LONGEST ALULA FEATHER IN TEN ANHINGAS AND TEN CORMORANTS

Species	Length		Length as percent of wing length	
	Extremes	Mean	Extremes	Mean
Anhinga	97-107	100.4	27.3-32.3	30.3
Cormorant	65-89	70.7	22.7-26.8	23.6

TABLE 6
THE LENGTHS OF THE CARPOMETACARPUS AND THE PHALANGES OF ANHINGAS AND CORMORANTS EXPRESSED AS PERCENTAGES OF LENGTH OF WING SKELETON¹

Measurement	Anhinga		Cormorant	
	Extremes	Mean	Extremes	Mean
Carpometacarpus	19.3-19.7	19.6	17.1-17.9	17.5
Digit II	6.3- 7.0	6.7	6.9- 7.2	7.0
Phalanx 1, digit III	7.9- 8.2	8.0	7.3- 7.9	7.6
Phalanx 2, digit III	6.8- 6.9	6.9	6.2- 7.1	6.9
Digit IV	4.0- 5.5	4.8	3.9- 4.6	4.2

¹ Based on three males and three females of each species.

The arc of the distance from the wrist to the tip of the longest primary averages longer in the Anhinga than in the cormorant (Table 4).

Primary feathers of both species are shown in Figure 1. Those of the Anhinga are the longer. Emargination of some primaries creates four more or less well-defined slots in the Anhinga wing and three in the cormorant wing. Slots have been shown to effect an increase in lift (important in slow flight) and to reduce vortices, which disrupt lift at the distal ends of the wings (Graham, 1932: 75).

The Carpometacarpus and the Digits.—Montagna's (1945) designation of digits is herein followed.

Relative to the length of the wing skeleton, digit II is slightly longer in the cormorant than the Anhinga (Table 6). The alula feathers, which are supported by digit II, are also long in the Anhinga: the mean length of the longest alula feather of the cormorants is only 70 per cent of that of the Anhingas. In the latter, this figure is 30.3 per cent of the mean wing length (arc of the closed wing); this value in the cormorant is only 23.6 per cent (Table 5). Graham (1932: 68) was among the first to point out

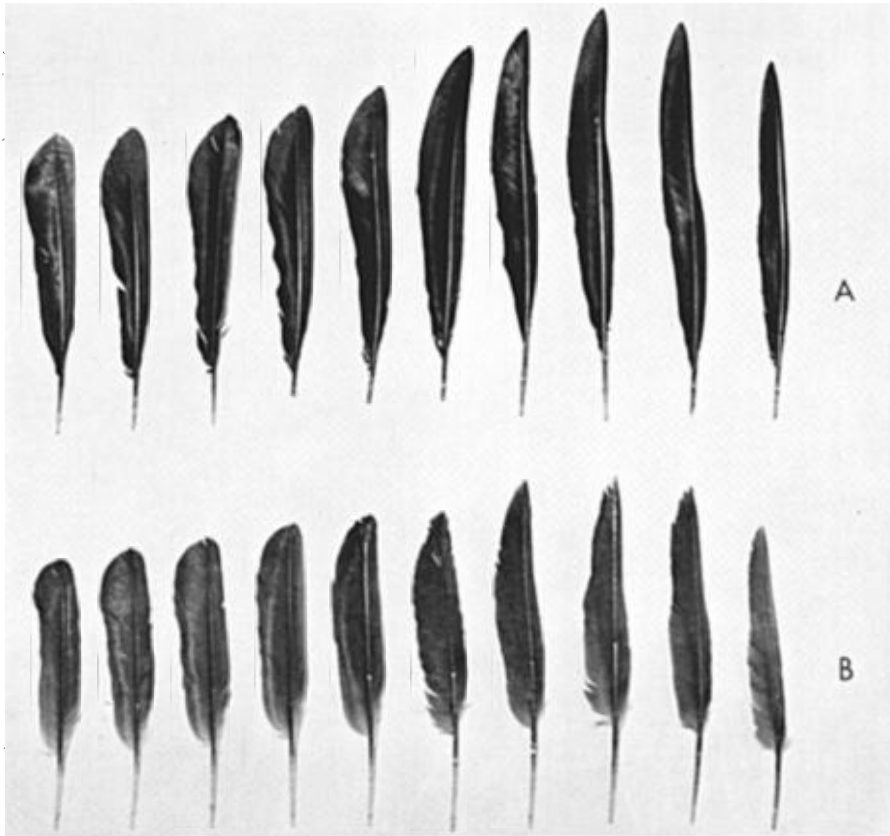

Figure 1. Primaries of the Anhinga (A) and the cormorant (B).

the importance of wing slots created by positioning of the alula feathers in preventing stalling at low flight speeds.

The carpometacarpus is slightly longer in relation to the total length of the wing skeleton and has a relatively larger extensor process in the Anhinga. Values of measurements of the carpometacarpus are given in Table 6.

The Pectoral Girdle.—Exact measurements of the scapula are difficult to obtain. The variably attenuated caudal tip is fragile and easily damaged, the bone is curved, and warping probably occurs when it is removed from the tension of attached muscles. It will be seen in Table 7 that the scapula is probably slightly longer in relation to the humeral length in the Anhinga than in the cormorant. In neither species is there a conspicuous blade or a well-defined neck. The actual area of articulation with the furculum and with the coracoid is probably broader in the cormorant. The scapula is an attachment for muscles important in humeral action and in anchoring the shoulder to the axial skeleton. Fisher (1946: 557) suggests that there

TABLE 7
MEASUREMENTS OF ELEMENTS OF THE PECTORAL GIRDLE OF THE
ANHINGA AND THE CORMORANT¹

	Anhinga		Cormorant	
	Extremes	Mean	Extremes	Mean
Scapula				
Length in millimeters	65.2 - 73.7	69.7	72.1 - 85.3	77.3
Length as percentage of total length of wing skeleton	50.3 - 60.0	56.0	53.2 - 58.8	55.0
Coracoid				
Length in millimeters	55.1 - 58.9	56.0	61.8 - 75.7	69.2
Length as percentage of total length of wing skeleton	17.1 - 17.8	17.5	16.7 - 21.3	17.9
Greatest diameter of proximal end as a percentage of length	31.6 - 42.7	37.1	35.5 - 40.0	38.6
Carina				
Length in millimeters	52.2 - 65.7	61.1	58.0 - 64.0	61.0
Area of both lateral surfaces in square centimeters	11.0 - 17.5	13.2	13.3 - 19.4	16.3
Per cent of lateral surface anterior to sternum	15.5 - 27.0	23.0	32.8 - 40.7	35.4
Square root of the area of the lateral surfaces divided by the cube root of body weight	.31- .40	.34	.29- .36	.32
Sternum				
Length from tip of lateral xiphoid process to anterior end of carina in millimeters	80.2 - 89.5	84.8	93.8 - 110.6	102.5
Length as percentage of total length of wing skeleton	24.8 - 27.5	26.7	23.7 - 29.2	26.0

¹Based on 3 males and 3 females of each species.

is a correlation between extensive articulation of shoulder elements and flapping flight.

Measurements of the coracoid (Table 7) indicate little difference between the species. Coracoidal length in relation to width and to the length of the wing skeleton is essentially the same in both. A greater degree of lateral movement of the coracoid is possible in the Anhinga since that portion of the bone articulating within the sulcus of the sternum is less curved than that of the cormorant. The surfaces of articulation with the furculum and the scapula are proportionally greater in the cormorant.

The furcula of the two species are essentially similar. The coracoidal articulations are well-developed. The furcular processes are elongated in both, but those of the Anhinga are the more attenuated. The area of contact with the scapula is slightly greater in the cormorant. The sterna of the Anhinga and the cormorant appear to exhibit greater comparative differences than do the other elements of the pectoral girdle and wing skeleton.

The difference in the position of the carina is considerable. In the Anhinga the carina rises from the sternal surface at the base of the median xiphoidal process, but its elevation is not pronounced along the caudal one-third of the sternal plate. In the cormorant the carina rises from the sternal

surface slightly caudal to the mid-point of the sternum. Approximately 35 per cent of the lateral surface of the carina lies anterior to the sternal plate in the cormorant, whereas only 23 per cent of this surface lies anterior to the plate in the Anhinga. It has been generally observed that the carina is situated farther forward in birds with a more flapping flight and farther back in birds with a more soaring flight.

The area of the lateral surface of the carina was obtained by measurement with a polar planimeter. While this measurement is not precise, since the exact point of elevation of the carina is difficult to determine, the estimates obtained are useful for comparison. Values obtained by dividing the square root of the area of the lateral surfaces of each carina by the cube root of body weight are not significantly different in the two species (Table 7). Thus, the differences in position of the carina seem of particular interest.

Fisher (1946: 561) attempted an evaluation of the depth of the dorsal trough of the sternum. Using a similar measuring procedure and the same standards of proportion (the width of the sternum between the intercostal spaces and the sternal length), I found the trough slightly shallower in the Anhinga than in the cormorant. Fisher (1946: 561) stated that greater depth of the sternal trough is correlated with a more flapping flight.

A single median xiphoid process and a pair of lateral xiphoid processes are present in both species. In the Anhinga the median process is wider and the lateral processes are relatively longer than in the cormorant. Four costal facets were found on all Anhinga sterna examined; four or five were found on the sterna of the cormorant. The sterno-coracoidal processes are wider in the cormorant than in the Anhinga. A ventral manubrial spine is present in both, but it is somewhat better developed in the cormorant. The dorsal lip of the coracoidal sulcus does not project as far forward as the ventral lip in the Anhinga. In the Anhinga the sulcus itself is noticeably less curved along its lateral axis than it is in the cormorant; a cross section of the sulcus in the Anhinga shows that the sides of the sulcus diverge cranially. Thus, a greater degree of lateral as well as ventral movement of the coracoid is indicated in the Anhinga as contrasted with the cormorant.

Pneumaticity.—Pneumaticity is often associated with soaring flight and large flying birds. Fisher (1946: 568) stated that the cathartids which flap the least and have the greatest soaring ability possess greatest pneumaticity. The cormorant has considerable pneumaticity. The humerus (Fig. 8), ulna, and, to some extent, the radius are bones with wide central cavities, and the sternum is perforated with numerous fossae along the anterior portion of its dorsal surface. Shufeldt (1902: 161) and others have commented upon the lack of pneumaticity in the Anhinga in which the wing elements are heavy, the central cavity of the humerus (Fig. 8) being of very small caliber; the sternum is non-pneumatic. Functional significance of the Anhinga's lack of pneumaticity is discussed later (page 107).

Myology of the Wing.—The following descriptions of wing muscles are based upon dissections of four specimens (two adult males and two adult females) each of the Anhinga and the cormorant. (Prior to this investigation a specimen of the nominate race of the cormorant was dissected.) The specimens were preserved in ten per cent formalin.

Muscles were dissected and removed for measurement of volume. Volumes were determined by measuring the displacement of water in calibrated vessels. Small-sample *t*-tests (Bailey, 1959) were used in comparing muscle volumes.

Except as otherwise noted, muscle terminology is that of Fisher and Goodman (1955).

The drawings represent, as nearly as possible, average proportions and usual muscle and bone orientation.

Muscle descriptions are for the Anhinga; if the muscle differs in the cormorant, this is discussed in the section entitled "Comparison" given for each muscle.

M. TENSOR PATAGII LONGUS

General.—I have followed Berger's (1956a: 282-283) interpretation of this muscle. It has a common belly with *M. tensor patagii brevis* (Fig. 2). It is a wide, thin, superficial muscle of the dorsal surface of the shoulder (see *M. tensor patagii brevis*). The tendon of insertion has a complicated origin from the combined bellies and from the tendon of *M. pectoralis superficialis, pars proapatagialis*.

Origin.—See *M. tensor patagii brevis*.

Insertion.—The tendons of *Mm. tensor patagii longus* and *tensor patagii brevis* arise separately from the common belly of these muscles (Fig. 2). The tendon of *M. tensor patagii longus* crosses that of *M. tensor patagii brevis* immediately distal to its origin and the two tendons fuse. The combined tendons receive a stout tendinous contribution from *M. pectoralis superficialis, pars proapatagialis*, and immediately distal to this, bifurcation of the tensor tendons occurs. The tendon widens and becomes elastic at the elbow; proximal to this the "biceps slip" of *M. biceps* inserts upon it. The tendon narrows to its former caliber along the antebrachium after making stout connections to the proximal portion of *M. extensor metacarpi radialis, pars anconeus*. Along the anteropalmal aspect of the wrist the tendon again widens; here it is applied to a small, semicartilaginous, oval mass, and to the fascia of the wrist and metacarpus. Insertion is upon the extensor process of metacarpal II (Fig. 17) and the proximal portion of the phalanx of digit II.

Action.—Weak extension of the carpometacarpus, digit II, and the manus in general; flexion of the antebrachium upon the brachium.

Comparison.—The volume of the belly of this muscle combined with that of *M. tensor patagii brevis* constitutes a somewhat greater percentage of the wing muscles in the Anhinga (Table 8), which is possibly but not clearly significant. In the cormorant, the fusion of the tendon with that of *M. tensor patagii brevis* continues for a greater distance distal to the origin of these. The "biceps slip" was found in only two of four cormorants dissected. The thickened portion of the tendon at the level of the elbow becomes largely fleshy in the cormorant; it was found to be elastic in the Anhinga.

M. TENSOR PATAGII BREVIS

General.—This wide, thin, superficial muscle of the dorsal surface of the shoulder (Fig. 2) has a common belly with that of *M. tensor patagii longus*. The caudal border of the belly is superficial to *M. deltoideus major*; its cranial half lies superficial to *Mm. deltoideus minor* and *coracobrachialis anterior*, and to a portion of *M. pectoralis superficialis*.

Origin.—Fleshy from the dorsodistal end and from the scapular tuberosity of the furculum (Fig. 11) and from the cranial end of the scapula (Fig. 10).

Insertion.—The wide, thin tendon rises from the length of the anterior border of the belly. At its proximal end this tendon has connections with those of *Mm. tensor patagii longus* and *pectoralis superficialis, pars proapatagialis*. The tendon is closely applied to the dermis of the proapatagium. The main insertion is upon the anconal surface of the proximal end of the ulna. This portion of the tendon gives off branches to the belly of *M. extensor metacarpi radialis, pars palmaris*. Proximal to the elbow a bifurcation from the main tendon joins a wide tendon branching from that of *M. tensor patagii longus*; the combined tendons insert upon the tendon of origin and the belly of *M. extensor metacarpi radialis, pars anconeus*.

Action.—Powerful extension of the antebrachium; insertions upon *M. extensor meta-*

carpi radialis contribute to extension of the carpometacarpus. Attachments to the remiges move these mesiad.

Comparison.—In the Anhinga the tendon receives a stronger contribution from *M. pectoralis superficialis*, *pars propatagialis* and is more closely attached to the dermis than in the cormorant. In the latter tendinous attachment from the deltoid crest is made to the tendon of the muscle and not to the belly of the muscle as in the Anhinga.

Discussion.—This is probably an important muscle in holding the wings slightly flexed during the spread-wing attitude the Anhinga assumes after emerging from the water; it may also be important in positioning of the wings as well as certain feathers during swimming.

M. PECTORALIS SUPERFICIALIS

General.—There are three well-defined divisions of this muscle in the Anhinga: *pars propatagialis*, a superficial layer, and a deep layer.

PARS PROPATAGIALIS

This is a fleshy, triangular, thin slip from the antero-lateral portion of the most dorsal part of the superficial layer (Figs. 2, 4). Its terminal aponeurosis attaches to the origin of the tendons of insertion of *Mm. tensor patagii longus* and *tensor patagii brevis*. There are no conspicuous differences of this division of the muscle in the two species.

SUPERFICIAL LAYER

This covers the greater portion of the sternum and occupies the sterno-humeral-furcular area (Fig. 3). Fleshy origin is taken from the caudal half of the ventral surface of the sternum, from the length of the ventrolateral surface of the carina (Fig. 12), and from the furculum (Fig. 11). Insertions are made upon the palmar surfaces of the deltoid and bicipital crests. That to the former crest is aponeurotic, that to the latter is mixed (Fig. 13).

DEEP LAYER

Garrod (1876a 340) called attention to the presence of this layer in the Anhinga. Volumetric comparison of the two layers shows that the superficial one comprises more than 80 per cent of the total volume of the muscle. The belly of the deep layer lies superficial to *M. supracoracoideus* (Fig. 5). The origin is fleshy from the carina, deep to that of the superficial layer (Fig. 11), and from the dorsolateral and mesial surfaces of the furculum (Fig. 12). The stout tendon of insertion, which lies superficial to the tendon of origin of *M. biceps*, attaches to a protuberance of the palmar surface of the distal end of the deltoid crest (Fig. 13). There are considerable aponeurotic attachments made upon the tendon of insertion (Fig. 5).

Action.—The superficial and deep layers are considered important in moving (and holding) the humerus in a downward (and forward) position and in depressing the leading edge of the wing.

Comparison.—A separate deep layer is not clearly delimited in the cormorant; no insertion corresponding to that of this layer in the Anhinga is present. The entire muscle constitutes a slightly greater percentage of the muscle volume of the wing in the Anhinga (Table 8).

Discussion.—This muscle is instrumental in bringing about the stroke of the wing that produces lift during flapping flight. It is significant that the muscle appears to comprise a slightly greater percentage of the total muscle volume of the wing in the Anhinga. If the combined volumes of both sides of the muscle are expressed as a percentage of the weight of the bird, the average (of four specimens of each species with the sexes equally represented) is found to be 12.1 per cent (range: 11.5 to 12.3 per cent) in the Anhinga and 9.1 per cent (range: 7.1 to 9.7 per cent) in the cormorant. The great climbing power of the Anhinga and its ability to flap briefly and then glide can be explained, I believe, to some extent on the larger size of this muscle.

It is difficult to determine the significance of the development of the deep layer in the Anhinga. In the cormorant a greater carinal area of origin lies cranial to the sternum than it does in the Anhinga. This must result in a greater force being exerted on the humerus from anteriorward than in the Anhinga. This may be compensated for, however, by the development of the deep layer in the latter and its rather distal insertion on the humerus. In this connection it should be noted that the deltoid crest extends distad to a greater extent in the Anhinga than in the cormorant.

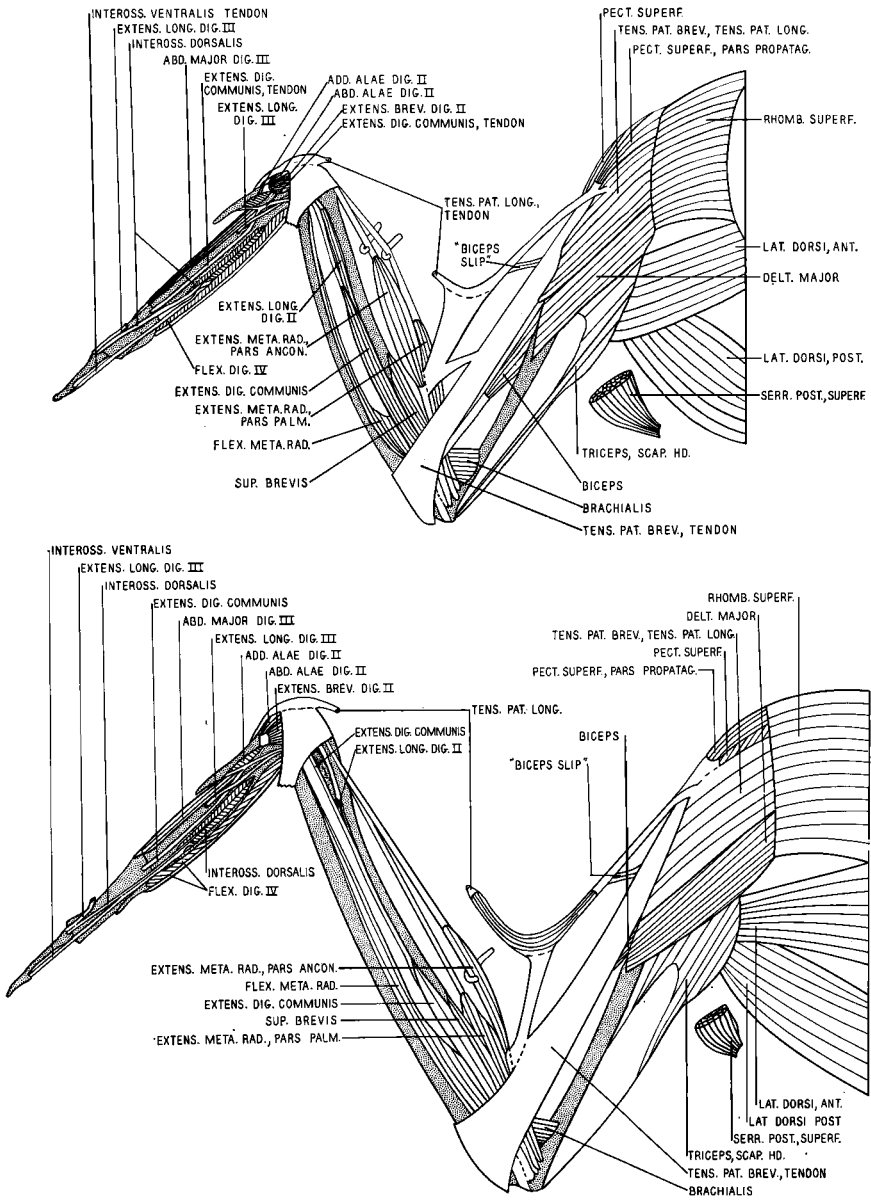

Figure 2. Dorsal view of the superficial muscles of the left wing of the Anhinga (*top*) and the cormorant.

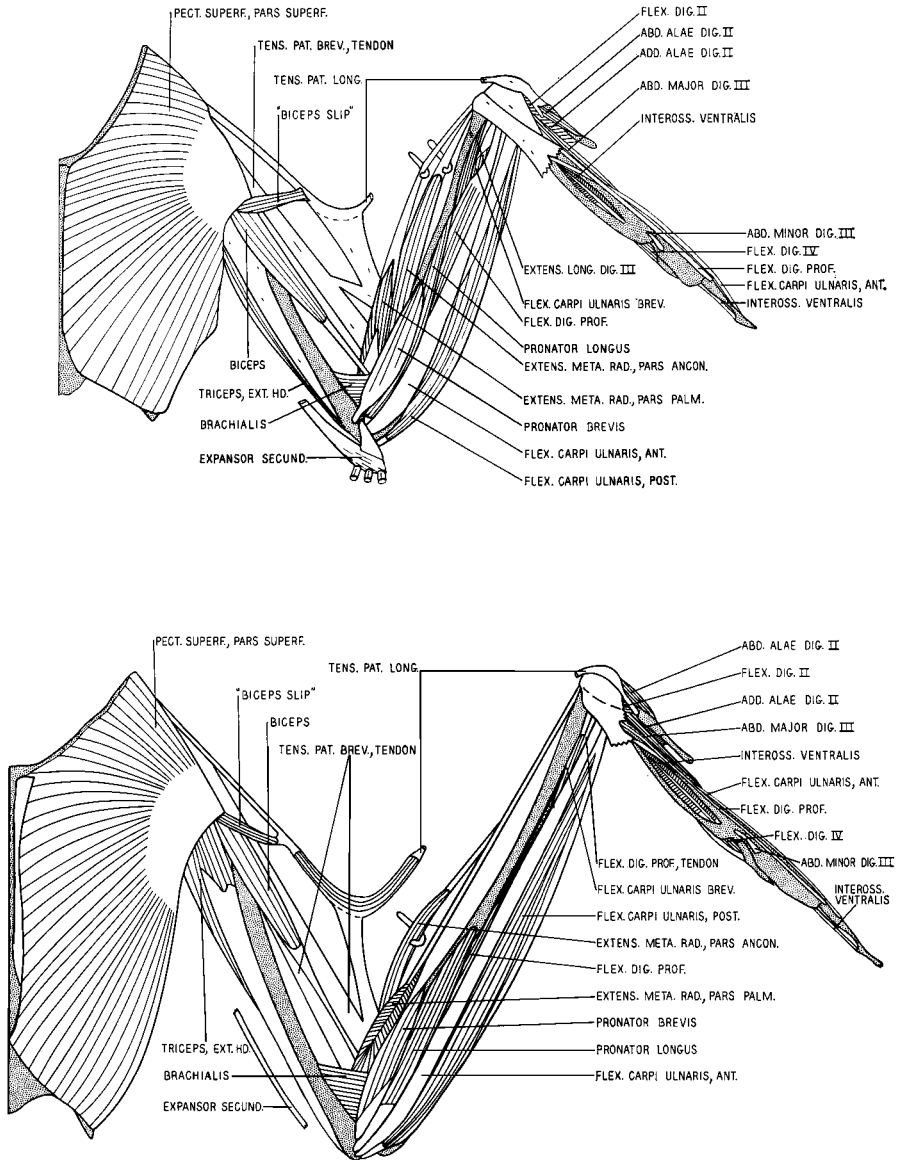

Figure 3. Ventral view of the superficial muscles of the left wing of the Anhinga (*top*) and the cormorant.

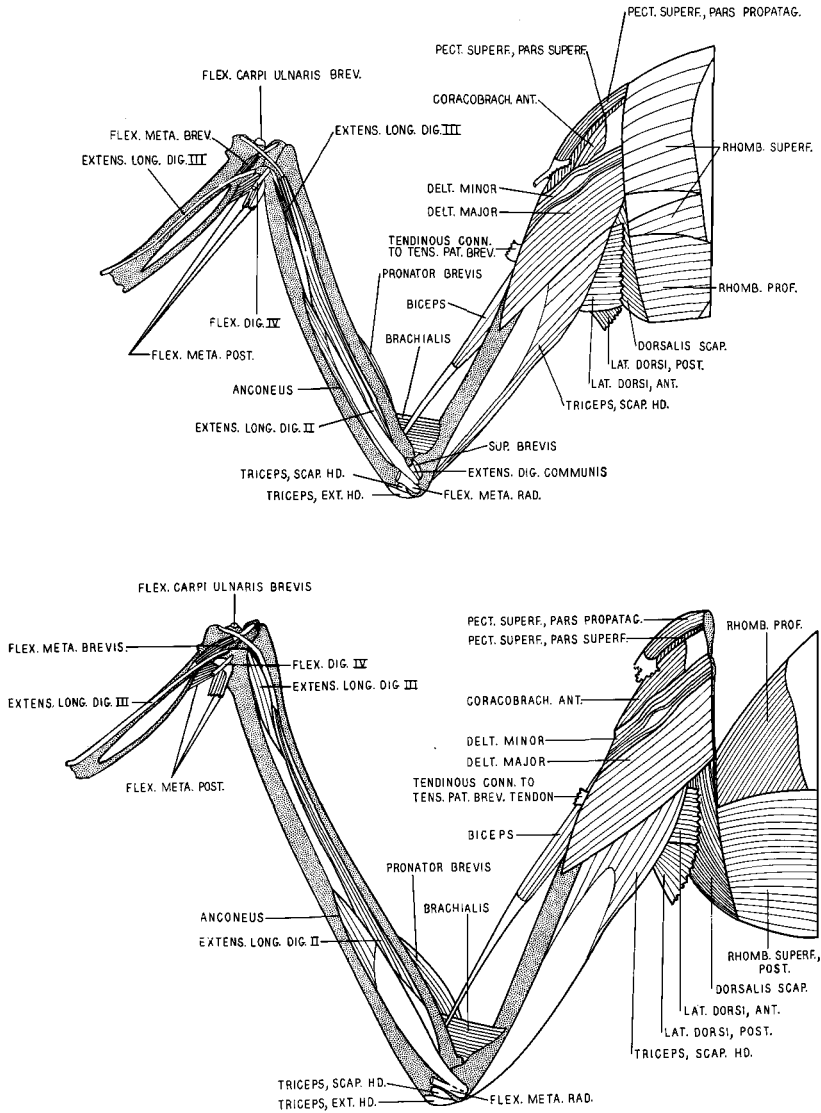

Figure 4. Dorsal view of a second layer of muscles of the left wing of the Anhinga (*top*) and the cormorant.

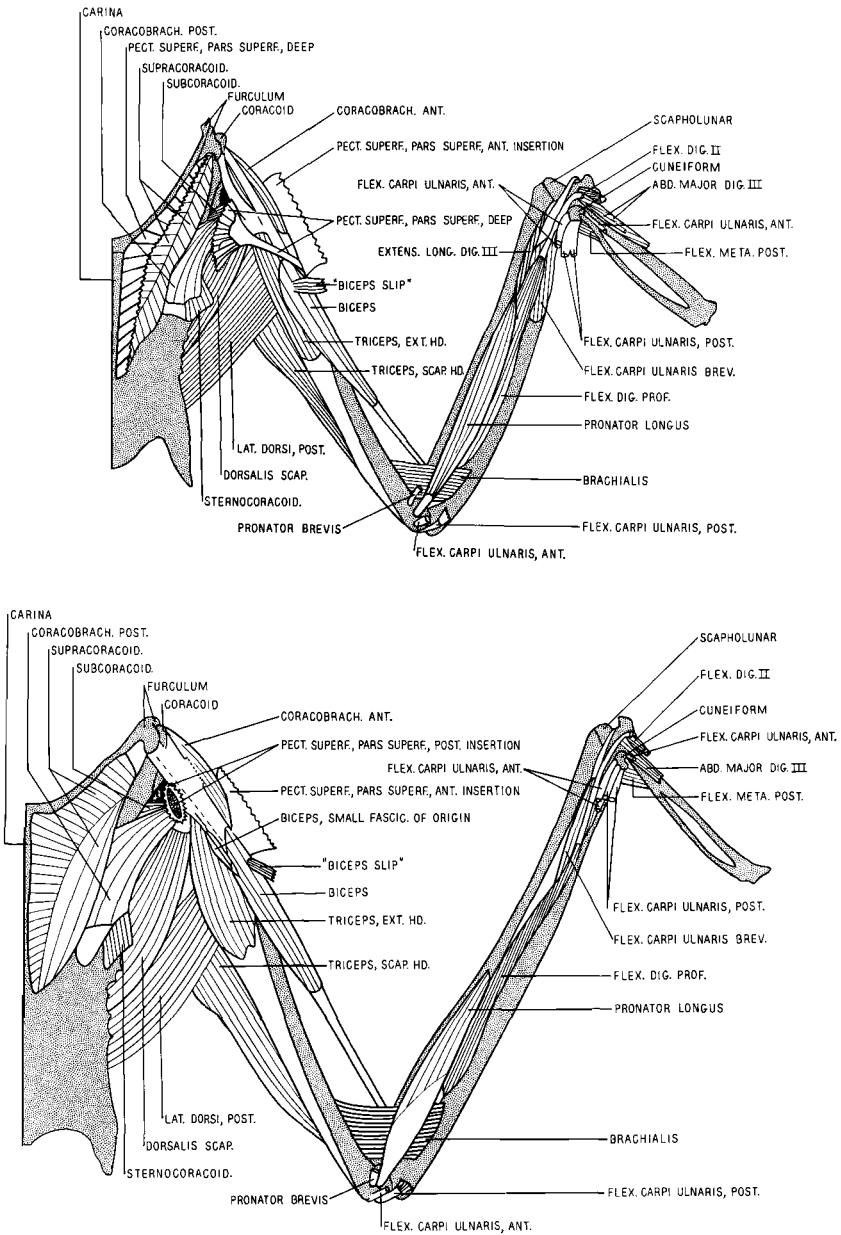

Figure 5. Ventral view of a second layer of muscles of the left wing of the Anhinga (top) and the cormorant.

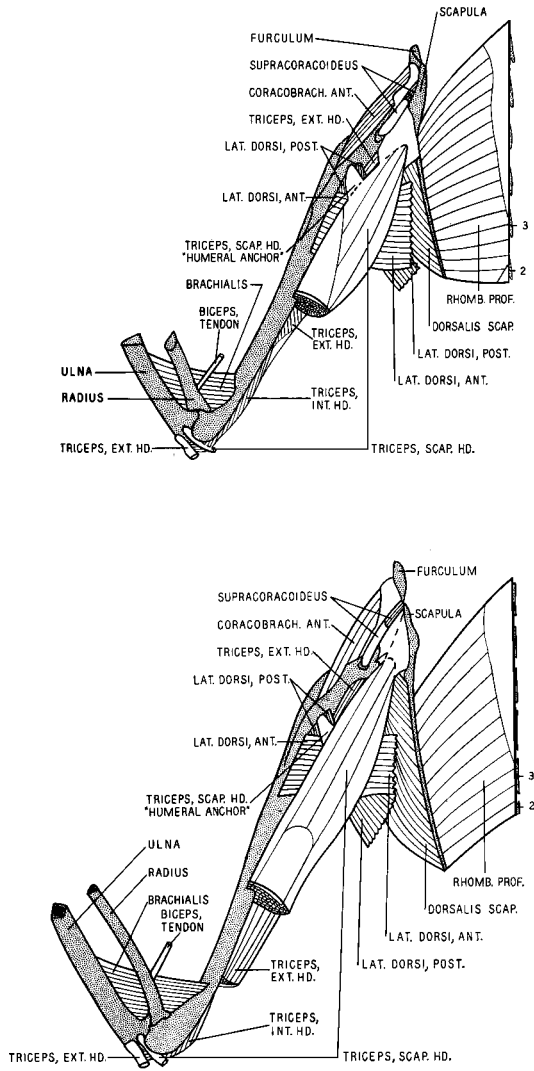

Figure 6. Dorsal view of a third layer of muscles of the left wing of the Anhinga (*top*) and the cormorant.

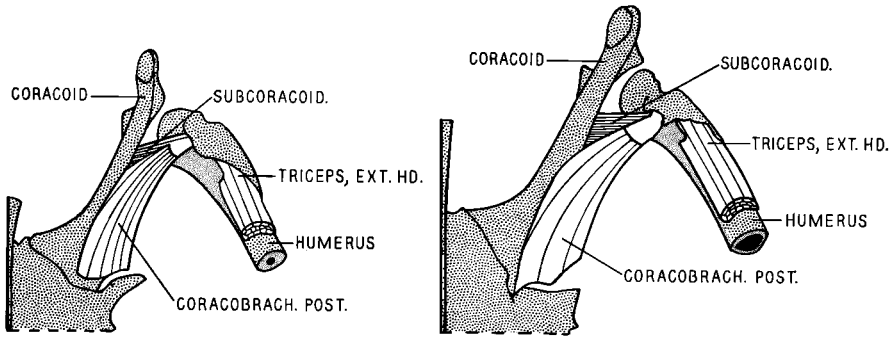

Figure 7. Ventral view of some deep muscles of the shoulder of the Anhinga (left) and the cormorant.

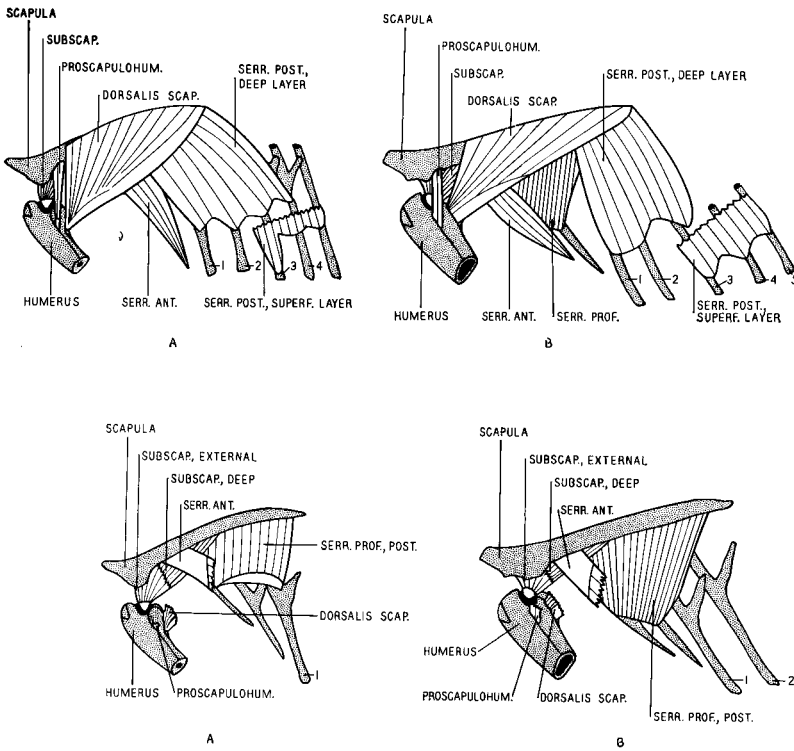

Figure 8. (Top) Lateral view of some muscles of the shoulder of the Anhinga (A) and the cormorant (B). (Bottom) Lateral view of a second layer of deep muscles of the shoulder of the Anhinga (A) and the cormorant.

The deep layer may have yet another significance. The Anhinga swims slowly while under water with its wings very slightly extended (page 61). The force of the deep layer, acting through its long, distally inserted tendon, may act to oppose the force of the water against the wing; it is not impossible that while underwater the wings may function to break forward momentum as well as act as stabilizers.

M. SUPRACORACOIDEUS

General.—This muscle lies along the ventral surface of the sternum and the mesioventral surface of the coracoid (Fig. 5). The belly is divided into lateral and mesial portions, which are closely applied to each other and which fuse distally. The lateral margin of the belly lies parallel to *M. coracobrachialis posterior*. The fibers of both halves of the muscle pass anterodorsally, converging along the mesial surface of the distal portion of the coracoid. The stout tendon of insertion is accompanied by a fleshy fasciculus as it passes through the triosseous canal.

Origin.—Fleshy from a large portion of the ventral surface of the sternum, the lateral surface of the carina (Fig. 12) and the anterior carinal margin, the lateral surface of the carinal-furcular articulation and from the furculum (Fig. 11), the anterior portion of the furcular origin being tendinous; fleshy from dorsal and ventral surfaces of the coracoid (Fig. 12). Origin is also taken from the caudal three-fourths of the sterno-coracoclavicular membrane.

Insertion.—By a stout tendon and a small fleshy fasciculus upon the external tuberosity of the humerus (Figs. 6, 13).

Action.—Principally, elevation of the humerus.

Comparison.—The volumes of this muscle constitute nearly the same percentage of total wing muscle volume in both species (Table 8). In the Anhinga, however, the origin of the muscle is made along a greater length of the furculum. The origin from the dorsal surface of the coracoid was not found to be as extensive in the cormorant as in the Anhinga.

Discussion.—It might be expected that this muscle would have greater development in the cormorant with its flapping flight than in a flapping-gliding, soaring bird. The rapid climbing flight of the Anhinga in still air is, in considerable part, probably made possible by this muscle, as is the Anhinga's greater dexterity in flight.

M. CORACOBRACHIALIS POSTERIOR

General.—*M. subcoracoideus* was found variably fused to the belly and insertion of this muscle (Figs. 5, 7).

Origin.—Fleshy from the laterodorsal and lateroventral surfaces of the coracoid (Fig. 12).

Insertion.—By a short, stout tendon upon the internal tuberosity of the humerus (Fig. 13). To this insertion may be fused that of *M. subcoracoideus*.

Action.—Rotates the humerus, increasing the angle of attack of the wing's leading edge. Slight flexion of the humerus and depression of the shoulder are also caused by its action.

M. LATISSIMUS DORSI

General.—This wide, thin, superficial muscle of the shoulder is divided into anterior and posterior fleshy portions, which are connected proximally by a stout aponeurosis (Fig. 2). The two parts converge distally, the belly of the posterior part lying deep to that of the anterior one as they pass between the bellies of the scapular and external heads of *M. triceps* to insert upon the humerus. Stout aponeurotic attachments are made by the bellies of both parts to the dermis of the scapular, humeral, and axillary regions; the posterior part has a stout fascial attachment to the superficial layer of *M. serratus posterior*.

Origin.—Both parts have a continuous origin from neural spines (and their interconnecting fascia and ossified ligaments) of the first five free vertebrae anterior to the synsacrum and from the anterior five millimeters or so of the neural ridge of the synsacrum. Origin was found to be aponeurotic from the fifth free vertebra anterior to the synsacrum, largely fleshy from the fourth such vertebra, mixed from the third, and fleshy from the second and first vertebrae, and the synsacrum.

Insertion.—The anterior part inserts fleshy upon the anconal surface of the humerus posterior to the insertion of *M. deltoideus major* (Fig. 13). The posterior part has a shorter insertion proximal to that of the anterior part (Fig. 13). The tendinous "humeral anchor" of the scapular head of *M. triceps* crosses the belly of the posterior part and inserts immediately anterior to it; a strong connection may exist between them.

Action.—Raises and adducts the humerus. The latter may also be rotated increasing the angle of attack of the leading edge of the wing. The dermal attachments are important in positioning feathers during both flight and swimming.

Comparison.—Volumetric measurements indicate that the muscle is very nearly the same relative size in the two species (Table 8). There are marked differences in the insertion of the muscle. In the cormorant considerable attachment is made by the posterior part to that of the anterior; in two cormorants dissected the insertions were common. The length of insertion of both parts upon the humerus extends for a considerably greater percentage of the humeral length in the Anhinga. Connections between the proximal portions of the anterior and posterior parts of the belly are by a stout aponeurosis in the Anhinga; these connections are relatively weak in the cormorant.

Discussion.—More powerful action of this muscle seems indicated in the Anhinga, in which the muscle may be of importance in adjustment of the leading edge of the wing during soaring flight; it may also function during underwater swimming when the brachium is held in a semi-flexed position.

M. RHOMBOIDEUS SUPERFICIALIS

General.—This muscle is more or less divided into anterior and posterior parts; in two specimens dissected the belly was found to be continuous and relatively limited in caudal extent. Where the belly of the muscle is divided, the divisions are connected by stout fascia. The posterior part lies deep to the anterior division of *M. latissimus dorsi*; the anterior part is in superficial view on the shoulder. Dorsal views of the muscle are shown in Figures 2 and 4.

Origin.—From neural spines and their interconnecting fascia. The origin extends from the third free vertebra anterior to the synsacrum, cranial to include the ninth vertebra. Caudal to the sixth free vertebra, the origin is more or less fleshy, while cranial to this, *Mm. rhomboideus superficialis* and *profundus* arise from a common aponeurosis which becomes more or less continuous across the dorsomedian line with the aponeurosis of the opposite side.

Insertion.—Fleshy upon the dorsal edge and the dorso-mesial surface of the scapula (Fig. 10) and upon the scapular end and scapular process of the furculum (Fig. 11).

Action.—Draws the scapula and furculum upwards and inwards and probably slightly posteriorly; acts as an anchor for the scapula.

Comparison.—This muscle is significantly larger in the cormorant (Table 8). The insertion extends for a greater length along the scapula, and the origin of the cranial portion of the muscle from a common aponeurosis with *M. rhomboideus profundus* is not apparent in the cormorant. The insertion upon the furculum is more extensive in the Anhinga.

Discussion.—Since the muscle acts as anchorage for the scapula, its greater size and longer area of insertion in the cormorant may be viewed as correlated with the flapping mode of flight of this bird. During soaring by the Anhinga, the muscle may function to raise the shoulder and the wing and thus lower the center of gravity. In correlation with this, the cranial portion is better developed and the insertion upon the furculum is more extensive than in the cormorant; the relatively greater insertion upon the furculum is important in lifting the latter and the heavy musculature attached to it. By lowering the center of gravity, added stability, important in soaring flight, is attained.

M. RHOMBOIDEUS PROFUNDUS

General.—The cranial two-thirds of this muscle lie deep to *M. rhomboideus superficialis*; the caudal portion lies deep to the posterior division of *M. latissimus dorsi* (Figs. 4, 6).

Origin.—From the neural spines, and fascia connecting these, of free vertebrae anterior to the synsacrum. The origin is largely by an aponeurosis from the third vertebra (in two of four specimens, it also arose from the second vertebra) cranially through the fifth vertebra. At the level of the sixth and seventh free vertebrae the aponeurosis widens and becomes a common one with that of *M. rhomboideus superficialis*.

Insertion.—Fleshy upon the dorsomesial surface of the scapula (Fig. 10).

Action.—Moves the scapula cranially, dorsally, and mesially; serves as anchorage for the scapula. The fibers of the muscle are oriented in a more cranial direction than are those of *M. rhomboideus superficialis*; it is probably of considerable importance in drawing the shoulder forward.

M. CORACOBRACHIALIS ANTERIOR (Figures 4-6)

Origin.—Fleshy from the lateral surface of the distal head of the coracoid (Fig. 12), and from the lateral surface of the coraco-humeral ligament.

Insertion.—Fleshy within the bicipital furrow of the humerus (Fig. 13).

Action.—Draws the humerus forward and probably rotates it slightly, thus depressing the leading edge of the wing.

Comparison.—The muscle tends to be of slightly greater relative volume in the cormorant (Table 8).

Discussion.—Fisher (1946: 583) believes that greater size of this muscle is an adaptation for soaring flight. This being the case, it would be expected to be larger in the Anhinga, which it is not. The deep layer of *M. pectoralis superficialis* may complement the action of this muscle, however.

M. DELTOIDEUS MINOR

General.—This small muscle (Fig. 4) lies deep to the common belly of *Mm. tensor patagii longus* and *tensor patagii brevis*. Deep to the central portion of its belly lies the insertion of *M. supracoracoideus* upon the external tuberosity of the humerus; when in certain positions this tuberosity creates a bulge in the belly of the muscle which may part the fibers to either side of it (Fig. 4). The caudal margin of the belly parallels *M. deltoideus major* and along the deep, distal portion of the belly fleshy fusion of variable extent may be made with that muscle.

Origin.—Fleshy from the lateral surfaces of the scapular tuberosity of the furculum (Fig. 11) and the furcular process of the scapula (Fig. 10). In one specimen the origin was restricted to the scapula.

Insertion.—Fleshy upon the anconal surface of the humerus extending from the external tuberosity to the mid-point of the deltoid crest (Fig. 13).

Action.—Raises, rotates, and extends the humerus.

M. SUBSCAPULARIS

General.—I have followed Berger (1956a: 285) in referring to this muscle as *M. subscapularis* rather than *M. proscapulohumeralis* and *M. subscapularis* as Fisher and Goodman (1955: 52) have called it. The muscle is stout and fan-shaped; it is divided into external and internal heads, which are separated by the tendon of insertion of *M. serratus anterior* (Fig. 8). The anterior portion of the belly lies contiguous to, or its external layer is crossed by *M. proscapulohumeralis*. The posterior three-fourths of the muscle lies deep to *M. dorsalis scapulae*. The posterior portion of *M. serratus profundus* passes deep to the mesial surface of the internal layer.

Origin.—Fleshy from the cranial two-thirds of the mesial surface and from the lateroventral edge of the cranial two-fifths of the scapular blade (Fig. 10).

Insertion.—External and internal layers have a largely tendinous, stout insertion within the capital groove of the humerus (Fig. 8); the insertion may be fleshy to a considerable degree, however, and it may extend onto the internal tuberosity. In one specimen dissected, the cranial portion of the mesial surface of the muscle made a fleshy insertion upon the laterodorsal surface of the cranial end of the coracoid; a similar, but weak, insertion was present in a second specimen.

Action.—Draws the entire humerus posteriorly and its posterior side up, rotating the leading edge of the wing downward. That portion of the muscle which may insert upon the coracoid would elevate that bone.

Comparison.—Insertion upon the coracoid was not noted in the cormorant.

M. DORSALIS SCAPULAE

General.—This is a stout muscle lying deep to the divisions of *M. latissimus dorsi* (Figs. 4-6, 8). Its cranial portion crosses the posterosuperficial surface of *M. subscapularis*. The muscle fibers pass in a ventrocranial direction, converging rapidly from a relatively wide origin to a narrow insertion on the humerus.

Origin.—Fleshy, from the caudal five-sixths of the lateral surface, and from the caudal two-thirds of the ventral edge of the scapular blade (Fig. 10).

Insertion.—Largely fleshy upon the crest bordering the pneumatic fossa (Fig. 13); the insertion may extend forward to meet the insertion of *M. coracobrachialis* upon the internal tuberosity.

Action.—Elevates the humerus and rotates it, depressing the leading edge of the wing. As with *M. subscapularis*, this muscle is important in the rapid changes of the angle of attack of the leading edge of the wing, which are pronounced in soaring and gliding flight.

M. SERRATUS POSTERIOR

General.—This muscle is divided into two well-defined parts (Fig. 8): a superficial or dermal layer, which is probably *M. serratus superficialis metapatagialis* of Berger (1956a: 287), and a deep layer passing to the scapula.

Origin.—The superficial layer takes fleshy origin from the lateral surfaces, ventral to the uncinat processes, of true ribs 3 and 4 and the false rib posterior to these; there may be fascial attachments to true rib 2. The deep layer takes fleshy origin from the lateral surfaces, ventral to the uncinat processes, of true ribs 1 through 4; in one specimen the origin did not extend to rib 4, in another it also rose from the uncinat process of cervical rib 2.

Insertion.—The superficial layer inserts fleshy upon the dermis underlying the scapular feather tract; widespread, tough fascia ramifies out under the dermis from this insertion. The deep layer inserts upon the caudal 25 millimeters or so of the ventral and ventromedial surfaces of the scapula (Fig. 10). The most caudal portion of the insertion meets, and fuses with, that of *M. rhomboideus profundus*. The cranial portion of the insertion, which crosses *M. subscapularis*, is aponeurotic.

Action.—The superficial layer depresses the feathers of the scapular tract. The deep layer draws the scapula downward and backward.

Comparison.—Comparisons of origins are difficult because the number of true ribs is variable in the cormorant. In the cormorants dissected the superficial layer originated from true ribs 3 through 5, and the deep layer from true ribs 1 through 3, and in some specimens from true rib 4.

Discussion.—It would be expected that the superficial layer which inserts upon the dermis would be better developed in the Anhinga, which has more elongate scapulars.

M. STERNOCORACOIDEUS

General.—This is a small, deep muscle of the ventro-cranial surface of the sternum (Fig. 5).

Origin.—Fleshy from the ventral surface and anterior edge of the sterno-coracoidal process (Fig. 12). The muscle may arise from the lateral surfaces of the two anterior costal facets. Origin also is taken from the lateral one-half of the dorsal lip of the coracoidal sulcus.

Insertion.—Fleshy within the sterno-coracoidal impression of the dorsal surface of the coracoid and upon the lateral edge of the sterno-coracoidal process of that bone (Fig. 12).

Action.—Elevates the coracoid and draws it laterally.

Comparison.—The volume of this muscle, in relation to the total volume of the wing musculature, is almost twice as large in the cormorant as in the Anhinga (Table 8). This development is perhaps correlated with force necessary to hold the coracoid in position during flapping flight. It should be noted that inspection of the coracoid in the Anhinga indicates that the bone is capable of being moved laterally and ventrally to a greater degree than in the cormorant.

M. SUBCORACOIDEUS

General.—This is a small, weak, variable muscle originating from the dorsal surface of the coracoid (Fig. 7).

Origin.—From the coracoid (Fig. 12) or from the membrane passing along its dorsal surface.

Insertion.—Upon the internal tuberosity of the humerus (Fig. 7) where, fleshy or tendinous, it may be surrounded by the insertion of *M. coracobrachialis posterior* or it may fuse entirely, or in part, with the insertion of the latter muscle. It may also fuse in insertion with *M. subscapularis*, or it may fuse with that portion of *M. subscapularis* which inserts upon the coracoid.

Action.—Any action of this muscle would appear negligible.

Comparison.—Variability in both species makes comparison impossible. Estimates of volumes were not obtained.

M. PROSCAPULOHUMERALIS

General.—According to Berger (1956a: 286) *M. proscapulohumeralis* is the correct name for the muscle called *M. proscapulohumeralis brevis* by Fisher and Goodman (1955: 53). It is a very small, short muscle passing from the scapula to the humerus (Fig. 8). The distal portion of the muscle may pass superficial to the external layer of *M. subscapularis*.

Origin.—Fleshy from the centrocaudal edge of the lateral surface of the scapula's coracoidal extension (Fig. 10).

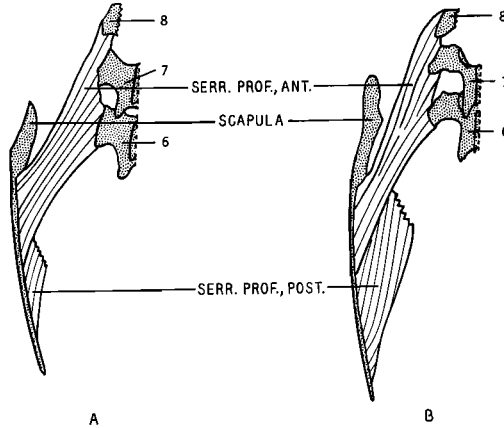

Figure 9. Dorsal view of *M. serratus profundus* of the Anhinga (A) and the cormorant (B).

Insertion.—Variably fleshy or tendinous upon the proximal end of the pneumatic fossa; the origin of the external head of *M. triceps* partially surrounds the insertion of *M. proscapulohumeralis* (Fig. 13). The insertion may extend to the base of the internal tuberosity.

Action.—Weak elevation, adduction, and probably rotation of the humerus; the latter action depresses the leading edge of the wing.

Comparison.—In the cormorant more extensive insertion was found outside of the pneumatic fossa than in the Anhinga .

M. SERRATUS PROFUNDUS

General.—This is a large muscle with a posterior division originating from the ribs (Fig. 8), and an anterior division originating from the vertebrae (Fig. 9).

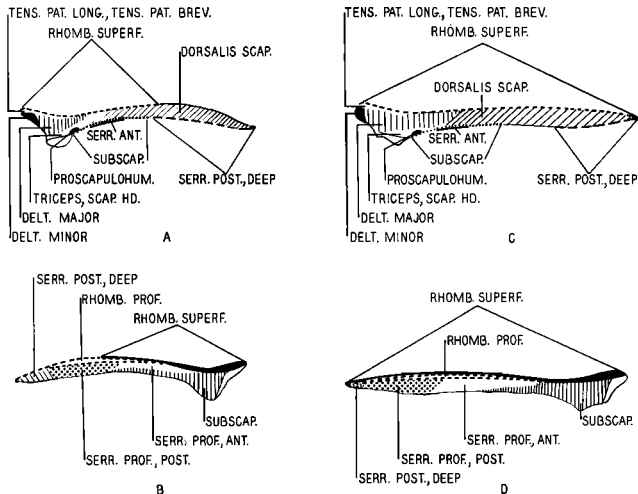

Figure 10. Lateral (A and C) and mesial (B and D) views of muscle origins and insertions upon the left scapula of the Anhinga (A and B) and the cormorant (C and D).

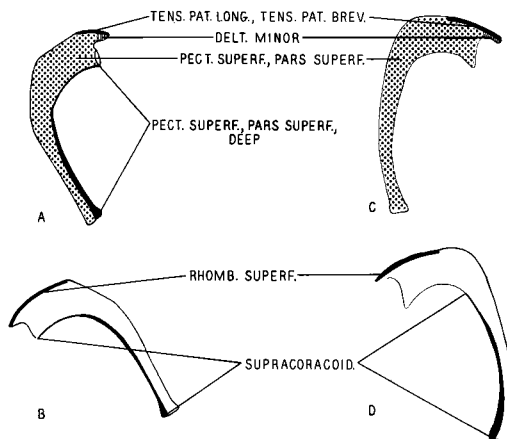

Figure 11. Lateral (A and C) and mesial (B and D) views of muscle origins and insertions on the furculum of the Anhinga (A and B) and the cormorant (C and D).

Origin.—Fasciculi of the anterior division have a mixed origin from the transverse processes of the sixth, seventh, and eighth free vertebrae anterior to the synsacrum. The origin may be restricted to vertebrae 6 and 7 or 7 and 8. In one Anhinga these fasciculi were joined by a short fasciculus arising from the dorsolateral surface of true rib 1.

The posterior division takes fleshy origin from the laterodorsal surface of true rib 1 and from the corresponding surface and uncinat process of cervical rib 2, and from the lateroposterior surface of cervical rib 1. In one Anhinga the origin was also from true rib 2.

Insertion.—Both divisions insert upon the mesial surface of the scapula (Fig. 10).

Action.—The anterior division elevates the scapula and draws it and the shoulder anteriorly, mesially, and, under certain conditions, laterally.

Comparison.—The posterior division appears larger in the cormorant and has more extensive origin, arising from true rib 2 and from a greater area of cervical ribs 1 and 2. There is little difference in the comparative volumes of the combined divisions (Table 8). In the cormorant the area of insertion of the posterior layer upon the scapula is more extensive. Both divisions of the muscle are apparently more variable in the cormorant, however, and comparisons are difficult to make.

M. SERRATUS ANTERIOR

General.—This small, flat muscle passes dorsocranially from the ribs to the scapula (Fig. 8). Along its deep surface it is closely applied to an aponeurosis to which is applied the deep layer of *M. serratus posterior*.

Origin.—Fleshy from the lateral surfaces of both cervical ribs; in one specimen origin was also from true rib 1.

Insertion.—By a wide, flat tendon upon the ventral edge of the scapula (Fig. 10). The tendon forms ventral to *M. subscapularis* and passes between the external and internal layers of this muscle.

Action.—Draws the scapula and shoulder down and posteriorly. According to Fisher (1946: 588) the ribs (of vultures) may be drawn laterally and dorsally.

Comparison.—In three of four cormorants dissected, the origin was restricted to the anterior cervical rib. The muscle is variable in volume (Table 8) and in origin; comparisons are without significance.

M. BICEPS

General.—The belly of this muscle, its tendon of origin, and its tendon of insertion are all three of approximately equal length (Figs. 3, 5). A small fasciculus, the "biceps slip," (Fig. 2) originates from the ventral surface of the proximal portion of the belly and inserts upon the tendon of *M. tensor patagii longus*.

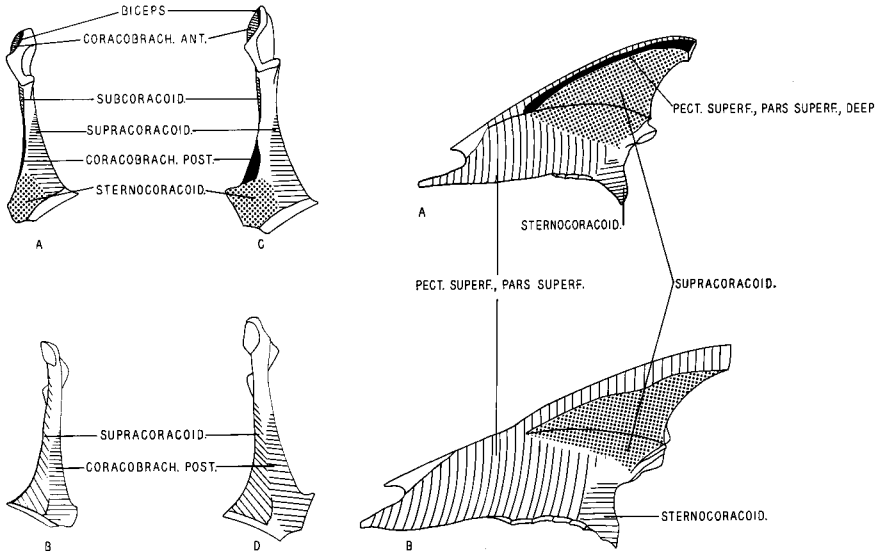

Figure 12. (Left) Dorsal (A and C) and ventral (B and D) views of muscle origins and insertions upon the coracoid of the Anhinga (A and B) and the cormorant (C and D). (Right) Lateral view of muscle origins from the sternum of the Anhinga (A) and the cormorant (B).

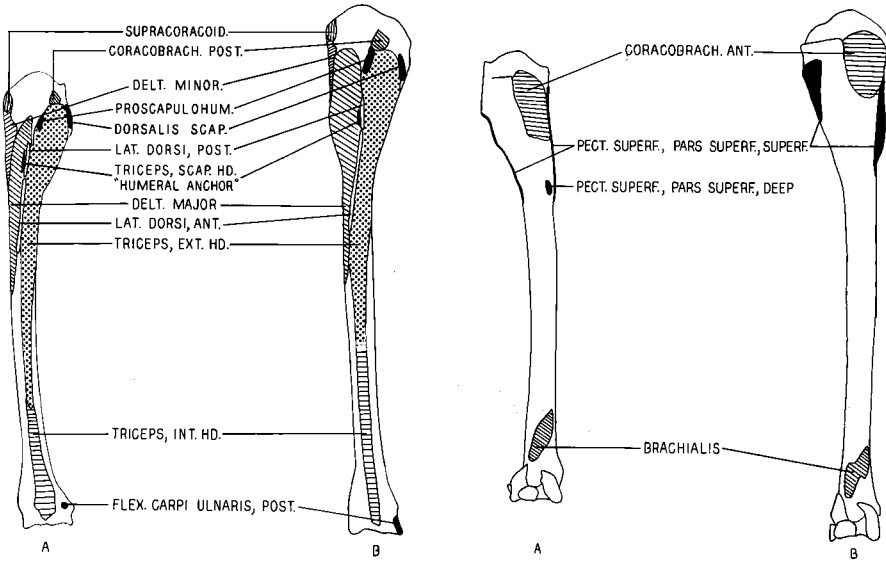

Figure 13. Muscle origins and insertions upon the anconal (left) and palmar (right) surfaces of the left humerus of the Anhinga (A) and the cormorant (B).

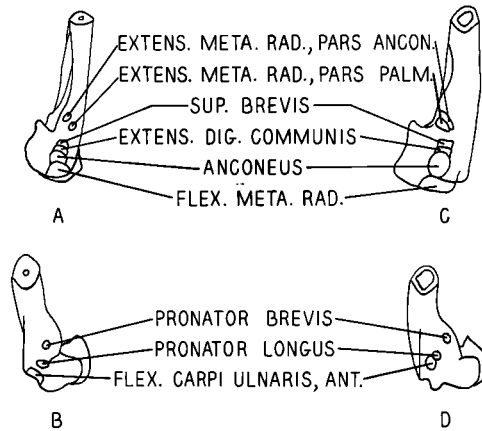

Figure 14. Muscle origins and insertions upon the distal end of the left humerus of the Anhinga (A and B) and the cormorant (C and D).

Origin.—By a long, flat tendon from the coracoid along the dorsoanteroventral border of the origin of *M. coracobrachialis anterior* (Fig. 12). This tendon is attached to: the surface of the latter muscle by stout fascia, the bicipital surface of the humerus by stout fascia, tendinous material passing from *M. pectoralis superficialis* to the bicipital crest, the tendon passing from the coracoidal head (and furcular articulation) to the deep layer of *M. pectoralis superficialis*.

Insertion.—The tendon passes to the elbow dorsal to *M. brachialis*. It inserts upon the proximoposterior surface of the radius (Fig. 16). A tendon, which in some specimens has direct connections to the radial insertion, passes to the distal end of the brachial impression of the ulna (Fig. 15); this tendon was not present in one specimen.

Action.—Flexion of the antebrachium; rotation of the latter to depress the wing's leading edge. Action of the "biceps slip" is probably that of contributing to tension upon the propatagium; any action upon the carpometacarpus through the tendon of *M. tensor patagii longus* must be very weak.

Comparison.—This muscle is significantly larger in the cormorant (Table 8). In this species a small, fleshy fasciculus, the "short head," inserts upon the fascia of the postero-palmar surface of the belly (Fig. 5); this originates from the tendinous attachments of *M. pectoralis superficialis* upon the bicipital surface. In the Anhinga the insertion on the radius is more distal than in the cormorant.

Discussion.—The greater volume and stronger humeral attachments and differences in points of insertion indicate somewhat different muscle action in the two species. The more distal insertion in the Anhinga, however, may compensate, in some measure, for the smaller muscle in that species. A more distal insertion indicates greater power of action with less speed. Holding the outstretched wing down during soaring or gliding flight may be an important function of the muscle in the Anhinga, whereas it may be of importance in antebrachial flexion during the cormorant's flight.

M. DELTOIDEUS MAJOR

General.—The posterior portion of this stout muscle is in superficial view (Fig. 2); the anterior portion of the belly parallels *M. deltoideus minor* and lies deep to the combined bellies of *Mm. tensor patagii brevis* and *tensor patagii longus* (Fig. 4). Its superficial surface has stout fascial connections to the dermis underlying the scapular feather tract.

Origin.—Fleshy from the lateral surface of the scapula (Fig. 10). A stout fascial connection exists between the deep surface of the muscle and the attachments of the scapular head of *M. triceps* to the bicipital area.

Insertion.—Fleshy upon the anconal surface of the humerus from the level of the internal tuberosity to a point distal to the deltoid crest (Fig. 13). The insertion, distal to that

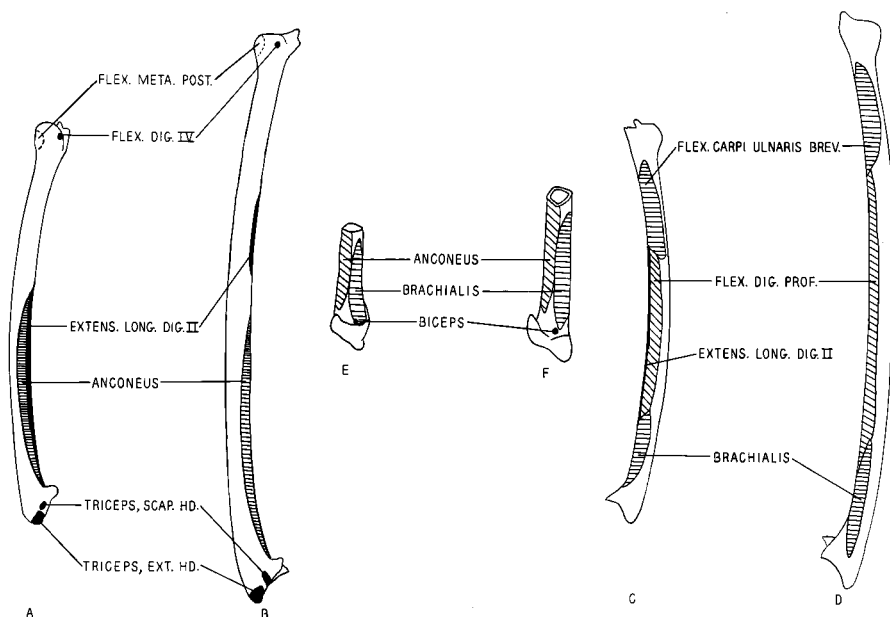

Figure 15. Muscle origins and insertions upon the left ulna of the Anhinga (A, C and E) and the cormorant (B, D and F). Anconal views (A and B), palmar views (C and D), and anterior views (E and F).

of *M. deltoideus minor*, is upon the deltoid crest; the distal portion of the insertion upon the humeral shaft becomes tendinous.

Action.—Flexes and elevates the brachium; rotates the leading edge of the wing increasing the angle of attack.

Discussion.—Although the volume of the muscle is smaller in the Anhinga, its comparative effectiveness in the latter would seem to be increased because it inserts along approximately 39 per cent of the length of the humerus, whereas in the cormorant the insertion is along approximately 22 per cent of the humeral length.

M. TRICEPS

SCAPULAR HEAD

General.—The belly is in superficial view along the distal two-thirds of the anconal surface of the brachium; proximally the belly lies deep to *M. deltoideus major* (Figs. 2, 4, 5, 6).

Origin.—By a wide aponeurosis from the lateral surface of the scapula (Fig. 10); from the anconal surface of the humerus adjacent to the base of the internal tuberosity; by a tendon, known as the "humeral anchor," which rises from the humeral shaft contiguous to the juncture of the insertions of the anterior and posterior portions of *M. latissimus dorsi* (Fig. 13). From the insertion arising from the area of the internal tuberosity, variable connections may be made to the belly of *M. deltoideus major*.

Insertion.—The large tendon, which forms along the distal one-fifth of the humerus, passes through the external tricipital groove and inserts upon the ulna between the olecranon process and the external cotyla (Fig. 15).

EXTERNAL HEAD

General.—The belly which is, in part, superficial upon the palmar surface of the brachium (Figs. 3, 5, 6, 7), lies ventral to the belly of the scapular head. The tendon of origin and the proximal portion of the belly of *M. biceps* cross its ventroanterior surface.

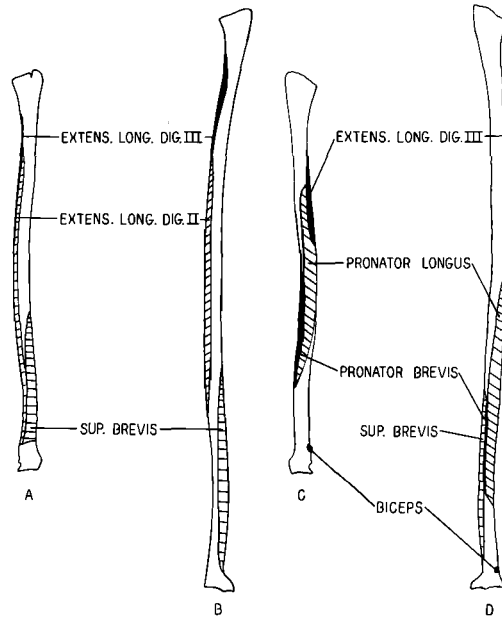

Figure 16. Muscle origins and insertions upon the left radius of the Anhinga (A and C) and the cormorant (B and D). Anconal views (A and B), palmar views (C and D).

Origin.—Largely fleshy from the pneumatic fossa, the adjacent surface of the bicipital crest, and the proximal three-fourths or so of the palmar surface of the humeral shaft (Fig. 13).

Insertion.—The stout tendon forms along the distal fifth of the humerus; it passes through the internal tricipital groove and inserts upon the apical three-fourths of the olecranon process (Figs. 4, 15).

INTERNAL HEAD

General.—This is small and more or less distinct. It lies along the posterodistal third of the humerus, taking weak origin from (thus being connected with) both the scapular and external heads (Fig. 6).

Origin.—Fleshy, from the distal third of the posterior surface of the humerus (Fig. 13) and from the scapular and external heads of *M. triceps*.

Insertion.—The fleshy belly crosses the elbow between the tendons of the scapular and external heads; in some specimens it was found to have a fleshy insertion upon the olecranon process. Such insertion is variable, however, and may be relatively strong or very weak. Strong fascial connection is made to the external tricipital groove and weaker fascial connection to the inserting tendons of the scapular and external heads.

Action.—*M. triceps* is the powerful extensor of the antebrachium. Action of the scapular head also elevates the brachium and antebrachium; the external head depresses the antebrachium. Action of the internal head must be chiefly that of abduction of the antebrachium and of containing the tendons of the other two heads.

Comparison.—Table 8 indicates little difference in the total volume of this muscle between the species. Volumetric comparison of the individual heads, however, indicates that the development of these is not the same in the two birds. The scapular head is large in the Anhinga and comparatively small in the cormorant, whereas the external head is comparatively small in the former and large in the latter.

Discussion.—According to Fisher (1946: 591) the scapular head is of importance in holding the wing in a semi-flexed position during flex-gliding. Its comparatively greater size in the Anhinga, then, may be correlated with the flight habits of this species. It

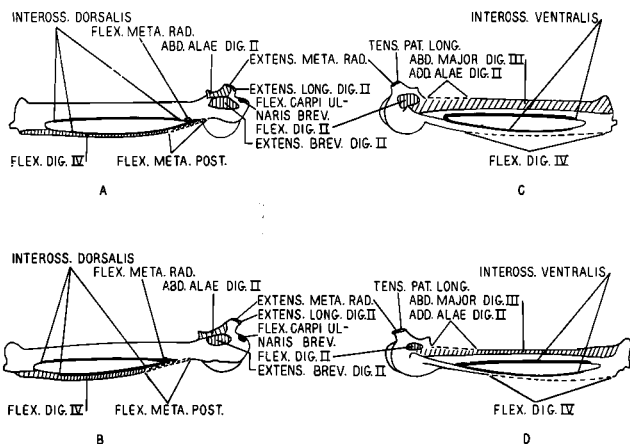

Figure 17. Muscle origins and insertions upon the carpometacarpus of the Anhinga (A and C) and the cormorant (B and D). Anconal (A and B) and palmar (C and D) views.

may also be an important muscle during underwater swimming by the Anhinga when the wing is held in a semi-flexed position.

M. BRACHIALIS

General.—See Figures 2-6.

Origin.—See Figure 13.

Insertion.—See Figure 15.

Comparison.—Insertion upon the ulna extends for a greater percentage of the length of that bone in the Anhinga.

Discussion.—The muscle is probably of comparable effectiveness in the two species.

M. EXPANSOR SECUNDARIORUM

General.—According to Garrod (1876b: 199) this muscle is absent in the Pelecaniformes. I found rudiments of the tendon of the muscle in all four of the Anhingas dissected and in one of the cormorants (Fig. 3). Muscle and tendinous material passing from the elbow to the remiges were found fairly well developed in only one Anhinga and in none of the cormorants.

Origin.—The slim tendon, which is intimately attached to the dermis of the parapatagium, could not be followed to its origin. In one Anhinga there were indications that a very small branch of it penetrated the lateroventral portion of *M. dorsalis scapulae*.

Insertion.—Fleshy upon the mesial three remiges with aponeurotic connections to the humerus (in one specimen).

Discussion.—Additional dissections with material specially preserved to remove the blood and fluids which usually congeal in this area will probably indicate that the muscle is present in most specimens of both species, but is variable, and probably to be considered rudimentary.

M. EXTENSOR METACARPI RADIALIS

General.—The two bellies of this muscle extend along the leading edge of the antebrachium (Figs. 2, 3). The belly of *pars anconalis* is approximately half as long as the antebrachium and is centrally located along it. The belly of *pars palmaris* extends along the proximal third of the forearm. The tendon of insertion of *M. tensor patagii brevis* crosses the dorsoproximal surface of the belly of *pars palmaris* and attaches to it as well as to the tendon of origin of *pars anconalis*. A branch from the thickened, elastic portion of the tendon of *M. tensor patagii longus* also attaches to the belly of *pars anconalis*.

Origin.—*Pars anconalis* originates by a tendon, approximately 25 millimeters long, from the distal end of the humerus proximal to the ectepicondylar process (Fig. 14). *Pars palmaris* originates by a short tendon, approximately five millimeters long, which rises immediately proximal to the origin of the tendon of *pars anconalis* (Fig. 14).

Insertion.—The two tendons pass through the ligament furrow of the distal head of the radius, that of *pars anconalis* being deep; they are contained within the furrow by tough fascia. Fusion of the tendons apparently occurs five to ten millimeters proximal to their common insertion upon the crest of the extensor process of metacarpal II (Fig. 17).

Action.—Powerful extension of the carpometacarpus and the manus. In a fresh specimen, the action can also be seen to depress the leading edge of the wing.

Comparison.—The tendons of insertion apparently unite at a more distal point in the Anhinga than in the cormorant. In the latter, fusion may occur proximal to the distal end of the radius.

The muscles are of approximately the same relative volume in both species (Table 8).

M. EXTENSOR DIGITORUM COMMUNIS

General.—This muscle lies along the proximoposterior portion of the anconal surface of the radius (Fig. 2). Anterior and posterior to it are, respectively, *M. supinator brevis* and *M. flexor metacarpi radialis*.

Origin.—Tendinous from a depression of the distal humeral head lying between the ectepicondyle and the ectepicondylar prominence (Fig. 14). *M. supinator brevis* takes origin from the anteroproximal part of the depression and *M. anconeus* arises from the distal portion.

Insertion.—The tendon forms midway along the radius and passes along the belly of *M. extensor longus digiti II*. It crosses the wrist upon the mesial surface of the external condyle of the ulna and continues along the anconal surface of metacarpal III. At the level of metacarpal II, the tendon bifurcates. A short branch passes obliquely anterodistally to insertion upon the anconal surface of digit II, approximately four millimeters distal to the proximal end of the phalanx. The larger branch of the tendon passes deep to the tendon of *M. extensor longus digiti III* and inserts upon the proximoanteroanconal surface of phalanx I of digit III. See Fig. 2.

Action.—Flexes digit II and, in so doing, obliterates the slot formed by the extension of the digit. Its action also extends digit III and elevates the manus.

Comparison.—The muscle appears to be essentially similar in both species.

M. SUPINATOR BREVIS

General.—The belly of this short, superficial muscle of the anconal surface of the antebrachium lies between the bellies of *Mm. extensor metacarpi radialis, pars palmaris* and *extensor digitorum communis* (Fig. 2).

Origin.—Tendinous from the distal end of the humerus immediately distal to the tendon of origin of *M. extensor metacarpi radialis, pars anconalis* (Fig. 14). Both the tendon of origin and the proximal surface of the belly are joined by heavy fascia which attaches to the external condyle of the humerus and to the capital tuberosity of the radius.

Insertion.—Fleshy, upon the proximal third of the anteroanconal and anterior surface of the radius (Fig. 16).

Action.—Elevates the forearm and rotates the leading edge of the wing upward. The latter action must be pronounced because the insertion along the anterior face of the radius continues to a more distal point than it does along the more anconal aspect.

M. FLEXOR METACARPI RADIALIS

General.—This is a superficial muscle which extends the length of the anteroanconal surface of the ulna (Fig. 2). *M. extensor digitorum communis* lies anterior to its proximal portion. A considerable portion of the anteroanconal surface of the belly is tendinous.

Origin.—Tendinous, in common with *M. anconeus*, from the ectepicondyle and from the tendinal pit between the ectepicondyle and the ectepicondylar prominence (Fig. 14). The tendon bifurcates from that of *M. anconeus* at the proximal end of the ulna. Distal to bifurcation the tendon is joined by considerable tendinous attachment from the proximo-posterior surface of the ulna.

Insertion.—The tendon of insertion crosses the anconal surface of the external condyle within a semicartilagenous loop and passes to its insertion upon the flexor attachment of the posteroproximal surface of metacarpal III (Fig. 17).

Action.—Flexion of the carpometacarpus and of the antebrachium; the carpometacarpus is probably elevated.

Comparison.—Volumes of the muscle are similar in the two species (Table 8). In the cormorant, the deep surface of the belly is fused, to some extent, with that of *M. anconeus*. Such fusion is very weak or is lacking in the Anhinga. This fusion may result in slightly more powerful flexion of the antebrachium in the cormorant.

M. PRONATOR BREVIS

General.—This is a superficial muscle of the proximopalmar surface of the radius (Fig. 3). *M. pronator longus* lies deep to its posterior border.

Origin.—Tendinous from the palmar surface of the distal head of the humerus anterior and proximal to the ectepicondylar prominence (Fig. 14).

Insertion.—Fleshy upon the anteropalmal surface of the radius (Fig. 16). In two specimens of the Anhinga and the cormorant the insertion of the muscle continued along 52 and 42 per cent, respectively, of the length of the radius distal to its proximal end.

Action.—Flexes and depresses the antebrachium; depresses the leading edge of the wing.

Comparison.—The development of this muscle is essentially similar in the Anhinga and the cormorant, although the volume is significantly greater and the insertion continues farther distad in the Anhinga.

Discussion.—This muscle is probably important in soaring flight, when constant changes in the position of the leading edge of the wing must be made. Slightly larger size and more distal insertion in the Anhinga can probably be correlated with the soaring and gliding flight of this species.

M. PRONATOR LONGUS

General.—The proximoanterior margin of this stout muscle lies deep to *M. pronator brevis*, the proximoposterior border lies deep to the anterior portion of *M. flexor carpi ulnaris* (Figs. 3, 5).

Origin.—Tendinous from the palmar surface of the distal head of the humerus (Fig. 14); the tendon arises distal to that of *M. pronator brevis*.

Insertion.—Fleshy upon the palmar surface of the radius (Fig. 16); in one specimen weak insertion was also made to the ulna.

Action.—Flexion and depression of the antebrachium; slight rotation of it may also be effected.

Comparison.—Relative volumes (Table 8) are almost identical. The most distal point of insertion was fifteen per cent farther along the radius in the Anhinga than in the cormorant.

Discussion.—This is a more powerful muscle in the Anhinga because of its more distal insertion. This can probably be correlated with the importance of forearm muscles in changing the position of the antebrachium when the wing is outstretched during soaring flight.

M. EXTENSOR LONGUS DIGITI II

General.—This is a deep muscle of the length of the radio-ulnar space (Fig. 4). Its proximal portion lies deep to *M. anconeus*; anterior to the belly of *M. extensor digitorum communis*, the distal portion of the belly is in dorsal, superficial view (Fig. 2).

Origin.—Fleshy from the posteroproximal seven-eighths of the radius (Fig. 16) and from the anteropalmal surface of the ulna (Fig. 15).

Insertion.—The tendon crosses the dorsal surface of the wrist and parallels, posteriorly, the tendon of *M. extensor metacarpi radialis*. It may fuse with this tendon or make independent, or semi-independent, insertion upon the extensor process of metacarpal II (Fig. 17).

Action.—Extension of the carpometacarpus.

Comparison.—The ulnar origin is variable in the cormorant; it was entirely lacking in two of these and weak in a third.

Discussion.—Muscles of the antebrachium are important in changing the position of the wing distal to the wrist while the wing is in an extended position during flight. It would be expected that the muscle would be well developed in a bird with soaring flight.

M. ANCONEUS

General.—This muscle lies along the proximoanterior surface of the ulna deep to *M. flexor metacarpi radialis* (Fig. 4). *M. extensor longus digiti II* lies along its anterior border.

Origin.—By a common tendon with *M. flexor metacarpi radialis* from the tendinal pit lying between the ectepicondylar prominence and the ectepicondyle; origin of the tendon is also taken from the ectepicondyle (Fig. 14).

Insertion.—Fleshy upon the proximoanterior surface of the ulna for approximately 55 millimeters (Fig. 15).

Action.—Flexion and elevation of the antebrachium.

Comparison.—This is a significantly larger muscle in the cormorant (Table 8). Its distal point of insertion in the cormorant is approximately 52, and in the Anhinga, approximately 62 per cent of the length of the ulna distal to the proximal end of this bone.

Discussion.—This is an important muscle in the movement of the wing during flapping. Its greater size and more proximal insertion in the cormorant can probably be correlated with the mode of flight. The longer insertion along the ulna in the Anhinga may compensate to some extent for the smaller volume; slower, more powerful action is indicated in the latter.

M. EXTENSOR LONGUS DIGITI III

General.—This muscle lies along the distal portion of the posteropalmar surface of the radius (Fig. 4). The extreme distal end of the belly can be seen in superficial view of the dorsal surface.

Origin.—Fleshy for approximately 30 millimeters from the distal end of the posteropalmar and posterior surfaces of the radius (Fig. 16).

Insertion.—The tendon forms opposite the distal head of the radius. It crosses the head of the ulna within the tendinal groove between the external and internal condyles and then passes along the posterior portion of the anconal surface of metacarpal III. One-third of the length along the latter it is joined by the tendon of *M. flexor metacarpi brevis*. Insertion is upon the anterior surface of the proximal end of the terminal phalanx of digit III (Fig. 2).

Action.—Extends the terminal phalanx as well as the digit and the manus.

Comparison.—This and other muscles inserting upon the digits tend to be of greater volume in the Anhinga (Table 8), emphasizing the greater degree of motion of the digits concomitant with soaring and gliding.

M. FLEXOR DIGITORUM PROFUNDUS

General.—The small, thin belly of this muscle lies deep to the anterior division of *M. flexor carpi ulnaris* (Fig. 5); the distal portion of the belly lies superficial to *M. flexor carpi ulnaris brevis*.

Origin.—Fleshy from the anteropalmal surface of the ulna for more than 60 millimeters, the insertion beginning approximately 20 millimeters distal to the proximal end of that bone (Fig. 15).

Insertion.—The tendon forms along the distal one-fifth of the antebrachium. It passes anterior to the scapholunar, anterior to the pisiform process, and along the anteropalmal surface of metacarpal III (Fig. 3). Insertion is upon the anteropalmal surface of phalanx 2, digit III.

Action.—Extends and depresses the terminal phalanx as well as the entire digit.

Comparison.—Possibly very slightly larger in the Anhinga (Table 8).

M. FLEXOR CARPI ULNARIS

General.—This is a complex muscle of two main divisions each of which may be divided into two parts. Both divisions are superficial upon the posteropalmar surface of the antebrachium (Fig. 3). The anterior division, which Berger (1956a: 291) regards as *M. flexor digitorum sublimis*, has a superficial layer, which is tendinous, and a small deep layer, which has a fleshy origin from the superficial one.

Origin.—The superficial layer of the anterior division has a tendinous origin from the lateral surface of the ectepicondylar process (Fig. 14). The posterior division originates by a stout tendon from the mesial surface of the latter process.

Insertion.—The superficial layer of the anterior division inserts tendinously upon the proximopalmar surface of the cuneiform (Fig. 5); the tendon of the deep layer of the anterior division passes through the concavity of the cuneiform, along the palmar surface of the metacarpus, and inserts upon the anterodistal surface of phalanx 2 of digit III (Fig. 3). The posterior division inserts upon the cuneiform by two tendons which may, in part, fuse proximal to insertion (Fig. 5).

Action.—The superficial layer of the anterior division probably serves in maintaining an extended position of the antebrachium; it may, as the humerus is rotated, move the wrist. The deep layer of the anterior division extends digit III as well as the entire carpometacarpus. The posterior division flexes the forearm and carpometacarpus and depresses the leading edge of the latter.

Comparison.—In the Anhinga the posterior division is approximately four times larger than the anterior division; in the cormorant it is approximately twice the size of the anterior division. The posterior division of the Anhinga is larger than that of the cormorant, the anterior division of the latter is larger than that of the Anhinga.

Discussion.—Flexion of the antebrachium and the wing elements distal to it must be considerably facilitated by the greater development of the posterior division in the Anhinga. This action is an important one in soaring and gliding flight. The superficial tendon of the anterior division is considerably more developed in the Anhinga; since this apparently functions to hold the wing in an extended position, correlation of its development with flight habit seems evident.

M. FLEXOR CARPI ULNARIS BREVIS

General.—This short muscle is applied to the palmar and anterior surfaces of the distal end of the ulna (Fig. 5).

Origin.—Fleshy from the palmar and anterior surfaces of the ulna (Fig. 15). The origin may continue onto the proximomesial surfaces of the internal condyle.

Insertion.—The stout tendon passes beneath the fascia of the wrist, crosses the palmar condyle of the carpometacarpus and inserts upon the anteroproximal surface of the external condyle (Figs. 4, 17).

Action.—Flexes the manus and rotates it to decrease the angle of attack of its leading edge.

Comparison.—This muscle is of significantly greater size in the Anhinga (Table 8).

Discussion.—The muscle is important in the positioning of the distal end of the wing. Although Fisher (1946: 599) felt that no correlation can be made between the development of the muscle and the type of flight, its larger size in the Anhinga might well indicate a comparatively greater importance in a soaring, flap-gliding type of flight.

M. ABDUCTOR ALAE DIGITI II

General.—This is a well-developed muscle which passes from the palmar surface of the carpometacarpus to digit II (Fig. 3). The surface of the belly is crossed by the tendon of *M. tensor patagii longus*, which passes to insert upon digit II. The anterior portion of the muscle is in superficial view on the anconal surface of the wing.

Origin.—Fleshy and tendinous, from the anconal surface as well as the distal edge of metacarpal II (Fig. 17) and from the palmar surfaces of the inserting tendons of *M. extensor metacarpi radialis* and *M. extensor longus digiti II*.

Insertion.—Fleshy upon the proximal four-fifths of the anterior and anteropalmar surface of the phalanx of digit II. In two specimens, the insertion was tendinous and upon the distal end of the phalanx.

Action.—Abducts and depresses digit II.

Comparison.—In the Anhinga insertion is along the proximal four-fifths of the phalanx, while in the cormorant the insertion is upon the proximal third, or so, of that bone.

Discussion.—The alula is of greater functional importance in the Anhinga (page 10). This muscle, which abducts and depresses the phalanx upon which the bastard wing is supported, has a more extensive insertion upon this phalanx of the Anhinga than upon that of the cormorant.

M. ADDUCTOR ALAE DIGITI II

General.—See Figures 2 and 3.

Origin.—Fleshy from the anteropalmar surface of metacarpal III (Fig. 17).

Insertion.—Fleshy upon the proximal three-fourths of the posterior and posteroanconal surface of the phalanx of digit II (Fig. 3).

Action.—Flexes digit II and, since the origin is more palmar than the insertion, depresses the digit.

Comparison.—This tends to be a somewhat larger muscle in the Anhinga (Table 8), and the insertion continues to a more distal point upon the phalanx in this species.

M. FLEXOR DIGITI IV AND M. FLEXOR BREVIS DIGITI IV

General.—These form a single muscle that passes along the posterior surface of the carpometacarpus (Figs. 2 through 4).

Origin.—A long tendon, closely applied to the belly, arises from the palmar surface of the distal head of the ulna (Fig. 15), where it is closely connected to the wrist fascia. The belly has fleshy origin from the distal three-fourths, or so, of the posterior surface of metacarpal IV (Fig. 17). Fleshy fibers of *M. flexor metacarpi posterior* attach to its proximal portion.

Insertion.—Fleshy and tendinous upon the proximoposterior surface of the phalanx of digit IV.

Action.—Flexes digits IV and III as well as the entire carpometacarpus and manus.

Comparison.—Volumetric comparison of the muscle (Table 8) is probably inexact, inasmuch as this is a difficult muscle to dissect out intact. No differences were noted in the major features of the muscle in the two species.

M. ABDUCTOR MINOR DIGITI III

General.—This is entirely ligamentous, passing from the mid-point of the distopalmar surface of metacarpal III to phalanx 1 of that metacarpal (Fig. 3). Insertion appears to be somewhat more distal in the cormorant.

M. FLEXOR METACARPI BREVIS

General.—Hudson and Lanzillotti (1955: 35) regarded this small muscle as a distal head of *M. extensor longus digiti III*, upon which it inserts (Fig. 4).

Origin.—Usually tendinous from the fascia covering the scapholunar or distal to this, from the wrist fascia.

Insertion.—The belly passes deep to the tendon of *M. extensor longus digiti III* fleshy inserting upon it; distal to this the tendon itself inserts upon that of the latter muscle.

Action.—Any force exerted must be slight; it would tend to hold the tendon of *M. extensor longus digiti III* in place and probably reinforce its action.

Comparison.—This is a considerably larger muscle in the cormorant (Table 8), in which fusion of the belly of the muscle to the tendon of *M. extensor longus digiti III* is more extensive.

Discussion.—See *M. extensor longus digiti III*.

M. INTEROSSEUS DORSALIS

General.—This is a bipennate muscle (Fig. 2).

Origin.—Fleshy from surfaces of metacarpals III and IV bordering the interosseus space (Fig. 17). In one specimen the origin extended to the distal end of the external condyle.

Insertion.—The tendon forms along the proximal one-third of the belly. Insertion is upon the anteroanconal surface of the proximal end of phalanx 2 of digit III (Fig. 2).

Action.—Extends and elevates the distal phalanx of digit III as well as the digit itself.

M. INTEROSSEUS VENTRALIS

General.—See Figure 3.

Origin.—Surfaces of metacarpals III and IV bordering the interosseus space (Fig. 17).

Insertion.—The tendon passes anconally from the distal end of the interosseus space and along the anteroanconal surface of phalanx 1, digit III; insertion is upon the posterior surface of the distal phalanx of that digit (Figs. 2, 3).

Action.—Flexes and elevates digit III, particularly the distal phalanx of this digit.

M. EXTENSOR BREVIS DIGITI II

General.—This small muscle, which lies upon the dorsal surface of metacarpal II (Fig. 2), is contiguous along a portion of its anterior margin with *M. abductor alae digiti II*.

Origin.—Fleshy from the dorsal surface of metacarpal II and from a small adjacent area of metacarpal III (Fig. 17).

Insertion.—Largely tendinous upon the proximoanconal surface of the phalanx of digit II (Fig. 2).

Action.—Raises and extends digit II.

Comparison.—The considerably greater development of this muscle in the Anhinga (Table 8) is probably correlated with the larger alula in this species and the greater functional importance of this.

M. ABDUCTOR MAJOR DIGITI III

General.—This is a relatively stout muscle lying along the anterior surface of metacarpal III (Figs. 2, 3, 5). A tendon, originating from the pisiform process, is applied along the length of the belly.

Origin.—Largely fleshy from the anterior and distal surfaces of the pisiform process and, distal to this, fleshy from the length of the anterior and anteropalmar surfaces of metacarpal III (Fig. 17).

Insertion.—Largely fleshy upon the proximoanterior surfaces of phalanx 1, digit III.

Action.—Extends and depresses digit III.

Comparison.—In the cormorant the tendon passing from the pisiform process along the belly of the muscle is larger than that in the Anhinga. The origin of the belly of the muscle extends farther onto the palmar surface of the metacarpus in the Anhinga.

M. FLEXOR DIGITI II

General.—This is a small muscle of the palmar surface of the proximoposterior portion of the metacarpus (Figs. 3, 5).

Origin.—Fleshy from the depression of the carpometacarpus lying anterior to the pisiform process (Fig. 17).

Insertion.—Tendinous upon the proximopalmarposterior surface of the phalanx of digit II (Fig. 5).

Action.—Flexes and depresses digit II.

M. FLEXOR METACARPI POSTERIOR

General.—This is a complex muscle of rather extensive, poorly defined divisions. Fisher (1946: 605) considered the muscle tripartite in the New World vultures. Probably homologous but less well-defined divisions occur in the Anhinga and the cormorant. Only one of the divisions, that corresponding to the anterior anconal division described by Fisher (*loc. cit.*), could be accurately delimited and measured.

Origin.—The anterior anconal division takes tendinous and broad ligamentous origin from the anconal surface of the ulna (Fig. 15).

Insertion.—To the proximoposterior surface of metacarpal IV for approximately 12 millimeters and to quills of primary feathers. The insertion lies dorsal to the belly of *M. flexor digiti IV*; fleshy connection may exist between the two.

Action.—Flexes the carpometacarpus and the manus.

Comparison.—This is a comparatively larger muscle in the Anhinga (Table 8).

DISCUSSION

There are basic differences in the proportions of the lengths of the wing elements in the Anhinga and the cormorant. The forearm constitutes a greater proportion of the length of the wing skeleton in the cormorant than it does in the Anhinga; when the length of the wing is divided by the cube root of body weight, the difference in ulnar proportions is statistically significant. In the Anhinga, the humerus and the carpometacarpus plus digit III constitute a somewhat greater percentage of the length of the wing skeleton, although these differences do not appear to be significant. On the basis of this information, however, only limited correlations with function can be made. As Engels (1944: 66) pointed out, “. . . numerous factors other than wing-skeletal proportions are operative in determining flight type.”

The total length of the wing skeleton in the Anhinga is considerably less than in the cormorant wing. The primaries of the Anhinga are much longer than those of the cormorant, however, and despite the considerable difference in the length of the wing skeleton, the wing span is only slightly shorter in the Anhinga. Wing loading is significantly greater in the cormorant.

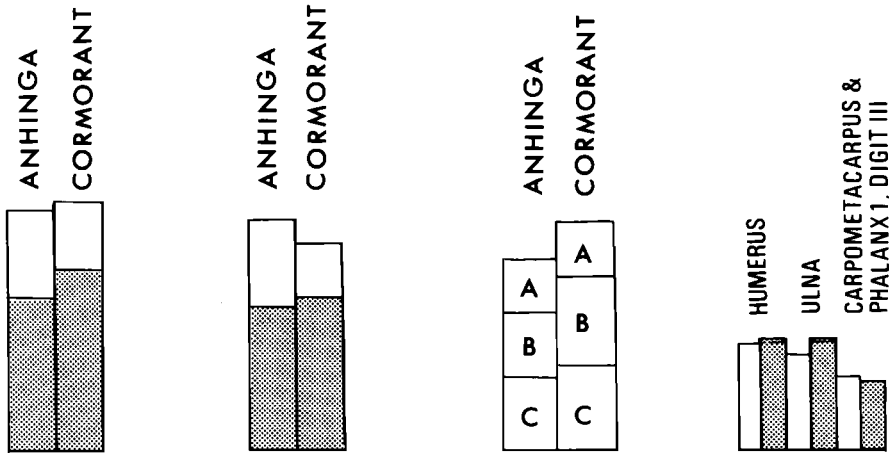

Figure 18. (From left to right) Length of the wing skeleton (stippled) as percent of the wing span. The same parameters adjusted to the cube root of body weight. The percentage of the length of the wing skeleton represented by the lengths of its individual units (A = carpometacarpus-phalanx I, digit III, B = ulna, C = humerus). Lengths of wing elements adjusted to the cube root of body weight (values for the cormorant are stippled).

A basis is now established upon which observed differences in flight may be explained. The heavy cormorant apparently must flap rather uninterruptedly to develop sufficient thrust along its short primaries. This thrust, in turn, draws the bird forward and creates lift along the elongated forearm. The comparatively light Anhinga develops sufficient thrust during slow, powerful, deep wing beats to enable it to glide for brief periods upon the lift derived. In thermals, obstruction currents, etc. the Anhinga with its lighter wing loading is well-adapted for soaring flight.

The Anhinga habitually climbs up into trees and bushes and then dives into flight. Observed efforts to take off from the water are ineffective. Wind is usually moving over the open water which the cormorant frequents, and much lift can be gained from this wind; necessary additional lift is gained by running across the water.

Modifications which facilitate slow climbing flight and landing are found in the Anhinga. Vanes of the distal primaries are emarginated or slotted to a greater extent than in the cormorant, and the alula is better developed. These are features which develop greater lift at low speeds. Emargination of the primaries is also an adaptation for soaring flight and for maneuvering in an arboreal habitat.

Comparison of the total volume of the wing muscles in the Anhinga and the cormorant is interesting. Average weight of the four Anhingas used in determinations of muscle volumes was 78 per cent that of the cormorants used. The wing-span of these Anhingas was 95 per cent that of the cormorants'. The average total volume of the muscles of the wing in these Anhingas was 99 per cent that of the average total volume of the wing muscles in the cormorants. Dividing the wing muscle volume by the cube root of body weight gives a value of 11.24 (extremes, 10.53 and 11.57) in

TABLE 8
VOLUME OF THE WING MUSCLES EXPRESSED AS PERCENTAGES OF THE TOTAL VOLUME OF
THE MUSCLES OF THE WING¹

Muscle	Anhinga		Cormorant	
	Extremes	Mean	Extremes	Mean
tensor patagii longus and tensor patagii brevis**	1.41- 1.63	1.52	0.87- 1.35	1.13
pectoralis superficialis	59.20-61.05	60.20	56.46-60.35	58.41
supracoaracoideus	5.70- 7.01	6.53	6.10- 7.37	6.72
coracobrachialis posterior and subcoracoideus	0.91- 1.02	0.96	0.83- 1.04	0.94
latissimus dorsi	2.35- 2.91	2.57	1.58- 3.44	2.60
rhomboideus superficialis***	1.06- 1.41	1.18	1.69- 2.21	1.88
rhomboideus profundus	1.05- 1.50	1.25	1.09- 1.82	1.44
coracobrachialis anterior	0.41- 0.67	0.58	0.61- 0.88	0.79
deltoideus minor	0.32- 0.46	0.38	0.23- 0.33	0.28
subscapularis	1.16- 1.46	1.33	1.48- 2.05	1.61
dorsalis scapulae	3.14- 3.42	3.31	2.68- 3.16	2.92
serratus posterior, superficial	1.18- 1.33	1.23	0.75- 1.18	1.06
serratus posterior, deep	0.74- 0.89	0.83	1.11- 1.50	1.27
sternocoracoideus**	0.41- 0.63	0.48	0.75- 1.05	0.95
proscapulohumeralis	0.06- 0.08	0.07	0.05- 0.08	0.06
serratus profundus	0.97- 1.38	1.15	0.75- 1.50	1.10
serratus anterior	0.20- 0.45	0.36	0.29- 0.61	0.46
biceps**	0.77- 0.91	0.82	1.17- 1.36	1.30
deltoideus major	1.82- 1.96	1.90	1.73- 2.54	2.32
triceps, scapular head*	2.93- 3.28	3.07	2.37- 2.78	2.59
triceps, external and internal heads**	2.51- 2.81	2.69	2.84- 4.00	3.20
brachialis	0.23- 0.40	0.30	0.42- 0.45	0.43
extensor metacarpi radialis	0.75- 1.00	0.92	0.83- 1.06	0.93
extensor digitorum communis	0.24- 0.33	0.29	0.23- 0.48	0.30
supinator brevis	0.11- 0.16	0.14	0.10- 0.22	0.15
flexor metacarpi radialis	0.47- 0.53	0.50	0.40- 0.51	0.46
pronator brevis**	0.63- 0.76	0.69	0.42- 0.55	0.48
pronator longus	0.86- 1.07	0.99	0.94- 1.03	1.00
extensor longus digiti II	0.31- 0.37	0.34	0.06- 0.36	0.18
anconeus**	0.40- 0.53	0.46	0.55- 0.65	0.63
extensor longus digiti III	0.15- 0.18	0.16	0.11- 0.15	0.13
flexor digitorum profundus	0.27- 0.35	0.31	0.23- 0.30	0.27
flexor carpi ulnaris	1.06- 1.31	1.19	1.13- 1.26	1.16
flexor carpi ulnaris brevis**	0.23- 0.29	0.26	0.16- 0.19	0.17
abductor alae digiti II	0.04- 0.08	0.06	0.04- 0.09	0.06
adductor alae digiti II	0.02- 0.12	0.06	0.03- 0.04	0.04
flexor digiti IV	0.05- 0.17	0.12	0.13- 0.22	0.16
flexor metacarpi brevis	0.01- 0.01	0.01	0.02- 0.03	0.02
interosseus dorsalis	0.05- 0.12	0.10	0.07- 0.12	0.09
interosseus ventralis	0.06- 0.08	0.07	0.03- 0.09	0.06
extensor brevis digiti II**	0.06- 0.10	0.07	0.01- 0.04	0.02
abductor major digiti III	0.11- 0.20	0.14	0.12- 0.13	0.12
flexor digiti II	0.04- 0.06	0.04	0.05- 0.08	0.06
flexor metacarpi posterior**	0.15- 0.38	0.25	0.06- 0.11	0.08

¹ Based on two males and two females each of the Anhinga and the cormorant.

** denotes a possibly statistically significant difference in volumes between the two species, *t* value expressing a probability between two and five per cent.

*** denotes statistically significant difference in volumes between the two species, *t* value expressing a probability of less than two per cent.

the Anhinga and in the cormorant 10.24 (extremes, 8.72 and 10.92). Thus, the Anhinga, a lighter bird with significantly less wing-loading, but with a nearly equal wing-span, has, in general, a greater volume of wing muscles relative to body weight than the cormorant. There being basic differences in the flight characteristics of the two species, it is obvious that the development of the wing musculature must be considerably different. (In this connection it may be noted that of 44 muscles or muscle divisions measured, eight, or 18 per cent, were found to have significantly different volumes in the two species.)

The data which follow are drawn from averages of volumetric determinations of the wing muscles in four specimens each of the Anhinga and the cormorant, the sexes equally represented. Differences in volume may not necessarily indicate greater ability or force of movement of skeletal elements, of course, since synergistic action, muscle shape and location, differences in origins and insertions, etc. modify function. It is believed, however, that cautious analysis of the data in Table 8 can be used in arriving at certain generalized comparisons between the species.

Muscles functioning in the movement of the scapula are: *Mm. rhomboideus superficialis*, *rhomboideus profundus*, *serratus anterior*, *serratus profundus*, and *serratus posterior, deep division*. These comprise 6.15 per cent of the total volume of the wing musculature in the cormorant and 4.77 per cent in the Anhinga. These muscles provide anchorage and foundation for the shoulder. That their greater development may be correlated with a greater degree of flapping flight is indicated by a comparison of the above values with those of Fisher (1946: 607), who found that these muscles constitute 3.12 per cent of the total wing musculature in *Cathartes* and 3.54 per cent in *Coragyps*. It is interesting that these birds can be listed in order of increasing degree of utilization of flapping flight as follows: *Cathartes* (3.12 per cent), *Coragyps* (3.54 per cent), *A. a. leucogaster* (4.77 per cent) and *P. auritus floridanus* (6.15 per cent). In the Anhinga and the cormorant these muscles may have the additional function of affording anchorage for the wing components during underwater progression.

Muscles contributing to movement of the humerus are *Mm. pectoralis superficialis*, *supracoracoideus*, *latissimus dorsi*, *deltoideus major*, *deltoideus minor*, *dorsalis scapulae*, *subscapularis*, *proscapulohumeralis*, *coracobrachialis anterior*, *coracobrachialis posterior*, and *M. triceps, scapular head*. The total volume of these muscles is 80.90 per cent of the total volume of the wing muscles in the Anhinga and 79.24 per cent in the cormorant. It should be noted that there is very little difference in the length of the humerus proportionate to the total length of the wing skeleton: 35.5 per cent in the Anhinga and 34.1 per cent in the cormorant. We may conclude that there is very little difference in the total bulk of the muscles contributing to movement of the humeri of the two species. (These values cannot be examined entirely from the aerodynamic standpoint, since the wing must be held in position during swimming, during sunning, during balancing, etc.) Groups of muscles contributing to directional movement of the humerus may be examined.

M. pectoralis superficialis is the principal muscle contributing to the movement of, and the force exerted upon, the humerus. This muscle com-

prised 60.2 per cent of the total volume of the wing muscles in the Anhinga and 58.4 per cent of this in the cormorant (Table 8). It was shown that the average volume of this muscle was equal to 12.1 per cent of the weight of the Anhingas it represented and 9.1 per cent of the weight of the cormorants. The faster climbing ability of the Anhinga, its ability to flap and then glide, and the constant flapping flight of the cormorant may possibly be correlated in considerable part with the comparative development of this muscle.

A larger proportion of the carina is anterior to the sternum in the cormorant than in the Anhinga. The forward pull exerted upon the humerus as a result of this extended area of origin of *M. pectoralis superficialis* is important in the power stroke of the wing. Origin from the anterior end of the furculum is more extensive in the Anhinga than in the cormorant. Thus it would seem that the angle from which the forward pull upon the humerus can be effected is as great in the Anhinga as in the cormorant, although the origins of *M. pectoralis superficialis* anterior to the sternum itself are not as massive. Again this is perhaps a correlation with modes of flight of the two species.

The area of origin of *M. pectoralis superficialis* from the caudal portion of the sternum is more extensive in the Anhinga. In addition, the carina extends farther caudad on the sternum and the xiphoidal processes are relatively longer in the Anhinga and origin of the muscle is from these latter surfaces as well. The more extensive development of the caudal area of origin in the Anhinga may be correlated with its gliding and soaring mode of flight. Downward pull upon the humerus is instrumental in holding the wings in outstretched position. Caudal (and cranial) extensions of the origin of *M. pectoralis superficialis* extend the arc through which this force is exerted.

The development of the deep layer of *M. pectoralis superficialis* with its narrow tendon inserted at the distal end of the deltoid crest results in a positive degree of downward force upon the humerus not found in the cormorant.

Other muscles exerting a downward pull upon the humerus are *Mm. coracobrachialis anterior*, *coracobrachialis posterior*, and *subcoracoideus*. The last is rudimentary. In the Anhinga these comprise 1.54 per cent of the total volume of the wing musculature and in the cormorant 1.73 per cent. The additional downward pull superimposed upon that of *M. pectoralis superficialis* by these muscles is slight. They are of importance in other action, as discussed subsequently.

Muscles which function in elevating the humerus are: *Mm. supracoracoideus*, *latissimus dorsi*, *deltoideus minor*, *deltoideus major*, *subscapularis*, *proscapulohumeralis*, *dorsalis scapulae*, and the scapular head of *M. triceps*. Although greater development of these would be expected to occur in a bird with a flapping type of flight, in both species they comprise almost exactly the same per cent of the total volume of the wing musculature.

Muscles which function in drawing the humerus posteriorly are: *Mm. latissimus dorsi*, *subscapularis*, *dorsalis scapulae*, *proscapulohumeralis*, *deltoideus major*, *deltoideus minor*, and the scapular head of *M. triceps*. These comprise slightly more than 12 per cent of the total volume of wing musculature in both species. The more pronounced effect of the action of

TABLE 9
 VOLUMES OF GROUPS OF MUSCLES WHICH CHANGE THE POSITION OF THE LEADING AND
 TRAILING EDGES OF THE BRACHIUM

Effect upon Brachium	Per cent of Total Volume of Wing Musculature	
	Anhinga	Cormorant
Muscles raising leading edge	5.81	6.14
Muscles depressing trailing edge and thus raising leading edge	0.96	0.94
Muscles depressing leading edge (excluding <i>M. pectoralis superficialis</i>)	0.58	0.79
Muscles raising trailing edge and thus depressing leading edge	4.64	4.53

M. latissimus dorsi, pars posterior, as a result of a more independent insertion in the Anhinga, has already been pointed out, as has been that of *M. pectoralis superficialis*, which exerts a more pronounced posterior force upon the humerus in that bird, although probably only when the wings are outstretched. It would be expected that greater development of muscles drawing the humerus posteriorly would be found in the cormorant because of its flapping flight. However, changes in the location of the center of gravity, important in soaring flight, are effected by anterior and posterior positioning of the wings as well as the shoulder.

Volumes of groups of muscles elevating or depressing the leading edge of the upper arm (*M. pectoralis superficialis* is the main depressor of the leading edge of the brachium) and elevating or depressing the trailing edge of the brachium are listed in Table 9. Those muscles which elevate the leading edge are *Mm. coracobrachialis posterior, latissimus dorsi, deltoideus major*, and *deltoideus minor*. *M. coracobrachialis posterior* depresses the trailing edge of the brachium and thus elevates the leading edge. *M. coracobrachialis anterior*, in addition to *M. pectoralis superficialis*, tends to depress the leading edge. *Mm. dorsalis scapulae* and *subscapularis* raise the trailing edge and depress the leading edge.

In the Anhinga and the cormorant, then, the volumes of the muscles contributing to movements of the humerus are essentially similar, but the angles from which force may be applied differ.

Flexors of the forearm are: *Mm. tensor patagii brevis, tensor patagii longus, biceps, brachialis, extensor metacarpi radialis, extensor digitorum communis, supinator brevis, pronator longus, pronator brevis, anconeus* and *flexor carpi ulnaris*. *Pars propatagialis* of *M. pectoralis superficialis* probably contributes to this action too, but it cannot be dissected from the rest of *M. pectoralis superficialis* for separate measurement. These muscles comprise 7.32 and 7.87 per cent of the total volume of the wing musculature of the Anhinga and the cormorant, respectively. The degree of development of the flexors of the forearm is supposedly correlated with the ability to flap. Hence the cormorant would be expected to have greater development of these muscles than the Anhinga; volumetric comparison does not indicate this.

The flexor muscles may be compared with respect to their insertions. Of those contributing to flexion of the forearm, *Mm. brachialis, supinator*

TABLE 10
 VOLUMES OF GROUPS OF MUSCLES ACTING UPON DIGIT II, EXPRESSED AS PERCENTAGES OF THE
 TOTAL VOLUME OF WING MUSCLES

Action	Anhinga	Cormorant
Extension	0.13	0.08
Flexion	0.39	0.40
Depression	0.16	0.16
Elevation	0.07	0.02

brevis, *pronator longus*, *pronator brevis*, and *anconeus* originate upon the humerus and insert upon either the ulna or the radius. Total volumes of these muscles represent 2.58 and 2.63 per cent of the total wing musculature in the Anhinga and the cormorant, respectively. Although differences in total volume are not significant, the insertions of these muscles are comparatively more distal upon the forearm in the Anhinga than in the cormorant. Thus it would seem that greater speed of flexion is possible in the cormorant, and greater power but probably a slower rate of flexion is indicated in the Anhinga, this seemingly correlating in both cases with the modes of flight of these birds.

M. triceps functions, in large part, to extend the antebrachium. It is of approximately equal size in the two species. The scapular head is larger in the Anhinga than is the external head; this situation is reversed in the cormorant. The external head functions in extension of the forearm; the scapular head flexes and elevates the humerus and extends the forearm. Elevation of the leading edge of the forearm is effected by *Mm. brachialis* and *supinator brevis*. Volumes of these are similar in the two species; however, their more distal insertions in the Anhinga indicate more powerful, probably slower action than in the cormorant. *Mm. pronator longus*, *pronator brevis*, and *anconeus*, which function to depress the leading edge of the forearm, have similar volumes in both birds. Again their insertions are more distal in the Anhinga. Thus, the Anhinga probably has greater power in raising and depressing the leading edge of the forearm. Correlation here is probably with respect to the necessity of changing the angle of attack of the wing during soaring and gliding flight; the fact that, when underwater, the wings are held slightly extended, might indicate importance of these muscles in this respect too. Additional muscles function in depressing and elevating the forearm during the extension of the wing, but it is difficult to analyze their action.

Flexion of the carpometacarpus is brought about by *Mm. flexor metacarpi radialis*, *flexor digitorum profundus*, *flexor metacarpi brevis*, *flexor metacarpi posterior*, and the posterior part of *M. flexor carpi ulnaris*. In the Anhinga these muscles comprise 2.26 per cent of the total volume of the wing muscles and in the cormorant 1.99 per cent of this value.

Extension of the carpometacarpus is effected by *Mm. tensor patagii longus*, *tensor patagii brevis*, *extensor metacarpi radialis*, *extensor digitorum communis*, *extensor longus digiti II*, *extensor longus digiti III*, and the anterior part of *M. flexor carpi ulnaris*. These comprise 4.42 per cent of the total wing muscle volume in the Anhinga and 3.83 per cent of this in

TABLE 11
 VOLUMES OF GROUPS OF MUSCLES WHICH CHANGE THE POSITION OF DIGITS III AND IV,
 EXPRESSED AS PERCENTAGE OF THE TOTAL VOLUME OF WING MUSCULATURE

Action	Anhinga	Cormorant
Extension	1.00	0.81
Flexion	0.19	0.22
Depression	0.45	0.39
Elevation	0.18	0.17

the cormorant. Both the muscles flexing and extending the carpometacarpus are somewhat larger in the Anhinga than in the cormorant.

It is difficult to calculate the comparative effects of muscles which rotate, depress, and elevate the carpometacarpus. It may be pointed out, however, that one of the most important of these, *M. flexor carpi ulnaris brevis* is significantly larger in the Anhinga.

Inserting upon digit II are *Mm. Abductor alae digiti II, adductor alae digiti II, flexor digiti II, extensor digitorum communis, extensor brevis digiti II, and tensor patagii longus*. These constitute 2.40 per cent of the total wing volume in the Anhinga and only 1.61 per cent of this value in the cormorant. If the volume of *M. tensor patagii longus* is excluded, these values are 0.88 per cent and 0.48 per cent in the Anhinga and cormorant respectively. Volumes of muscle groups moving digit II are given in Table 10. Excluded from this are volumes of *M. tensor patagii longus* since the effects of this are believed to be weak and indirect and the belly is a common one with another muscle. Muscles inserting upon digit II are grouped as follows: extensors—*Mm. abductor alae digiti II* and *extensor brevis digiti II*; flexors—*Mm. extensor digitorum communis, adductor alae digiti II, and flexor digiti II*; depressors—*Mm. abductor alae digiti II, adductor alae digiti II, and flexor digiti II*; elevator—*extensor brevis digiti II*.

Volumes of extensor and elevator muscles of digit II, then, are comparatively greater in the Anhinga. This may be correlated with the greater length of the alula and the greater functional significance of it in this species. The slot created by elevation and extension of digit II, which supports the bastard wing, increases the flow of air across the wing surface producing added lift necessary in slower flight. This is important to the Anhinga during its steep, climbing flight necessary in leaving growth-surrounded, small bodies of water, and in general maneuvering through an arboreal habitat. Use of the alula while submerged, as reported by Brooks (1945) in certain diving ducks, may be suspected for either species. (Critical observation of the wing while birds are underwater is much to be desired.)

Volumes of the muscles of digits III and IV are given in Table 11. (Digit IV, of course, is fused to digit III and is not capable of independent motion.) Extensors of these digits are: *Mm. extensor digitorum communis, extensor longus digiti III, flexor digitorum profundus, interosseus dorsalis* and *abductor major digiti III*. Flexion is accomplished by *Mm. flexor digiti III* and *interosseus ventralis*.

According to Fisher (1946: 623) greater development of the extensors, depressors, and flexors of these digits can be correlated with ability to soar.

Differences in the tendons and points of insertion of the muscles make comparisons difficult. On the basis of comparative muscle volume alone, however, this correlation is supported by the development of the extensors and depressors in the Anhinga. But there is slight difference in the comparative volumes of flexors and elevators.

CONCLUSIONS

The Anhinga has a shorter wing skeleton than the cormorant. In the former the functional length of the manus is increased by comparatively longer primaries. As a result of the longer remiges, the Anhinga has longer wings, somewhat wider wings, and less wing loading than the cormorant. It also has a greater mass of wing muscles in proportion to body weight than has the cormorant and is capable of soaring flight under favorable aerodynamic conditions. It is also capable of powerful wing action but probably slower strokes than the cormorant. This facilitates flight in an arboreal habitat and also allows flap-gliding flight similar to that of the accipitrines.

The general myology of the wing supports the above considerations. There has been considerable development of muscles adapted for soaring flight in the Anhinga; however, those muscles contributing to flapping flight are as well developed, generally, in the Anhinga as in the cormorant. The myology of the Anhinga wing, then, is one adapted for soaring, flap-gliding, and powerful flapping flight.

One might expect that specialization of muscles for certain types of flight would be accompanied by a relative reduction in those muscles facilitating other types of flight. This seems not to have occurred in the Anhinga.

The cormorant wing is not modified for soaring or for flap-gliding. That portion of the wing distal to the wrist being shorter moves through a smaller arc during flapping, and continuous flapping is thus necessary to produce the required thrust to keep the relatively heavier bird airborne.

The alula is comparatively longer in the Anhinga and the primaries are more extensively slotted. These are adaptations for slow flight and for soaring flight.

Although both species are essentially aquatic, they are none the less adapted for very different habitats. The cormorant seems adapted for exposed situations with long, unobstructed approaches to and from points of landing; in such situations there is usually wind, which facilitates landing and take-off. These conditions are typical of the marine littoral areas and of the larger bodies of fresh water. The Anhinga is apparently adapted for small, sheltered arboreal situations and for the aerodynamic conditions which develop over rapidly warming land masses and give rise to thermal currents which facilitate soaring flight once the bird is above the trees.

It is difficult to point out differences in the wing muscles to be considered useful in diagnosis of taxonomic relationships of the two species. *M. pectoralis superficialis* is conspicuously different in the two species in the development of the deep layer of this muscle in the Anhinga. Fisher and Goodman (1955: 43) found the two layers well defined in *Grus americana*, yet Berger (1956a: 284) found the muscle undivided in *Grus canadensis*. Since these must be closely related species, such differences in myology

must be regarded as *essentially adaptive*. However, differences exhibited in the myology of the wing of the Anhinga and the cormorant must indicate, at least, considerable divergence of these birds from any common ancestry.

It has been shown that there are basic differences in the proportions of the skeletal elements of the wing in the two species. In consideration of this it may be pointed out that Engels (1941: 66) indicated that hawks could be grouped according to these proportions and that these groupings correlated with the broader taxonomic groupings of the birds.

THE TAIL

Size, Functions, and Molt.—The long tail of the Anhinga is one of its most conspicuous characteristics. In twelve specimens (six males, six females) average length was 24.4 centimeters (extremes: 21.5 and 26.0 centimeters). In nine cormorants (five males, four females) tail length was 14.2 centimeters (extremes: 13.0 and 16.0 centimeters). Tail length represented 28.7 per cent of the total lengths of the Anhingas and 18.9 per cent of the total lengths of the cormorants.

The surface area of the tail was measured from an outline drawn with the rectrices spread to the extent that the widest point on each mesial vane touched the rachis of the next mesial rectrix; this resulted in a spread of the most lateral rectrices to an angle of 35 to 45 degrees from the longitudinal axis. Measurements of surface area were made as described for the wing (page 8). The average surface area of the tails of eight specimens of each species (sexes equally represented) was 138.9 square centimeters in the Anhinga and 54.1 square centimeters in the cormorant. The total surface area of the tail of the Anhinga, then, is approximately two and one-half times that of the cormorant (Fig. 19).

The large tail surface of the Anhinga must be important in supplying lift in addition to that supplied by the wings. Besides supplying lift, the tail is important as an elevator, rudder, and brake. One can easily observe the constant changes in position and spread of the tail of the Anhinga during soaring and during its accipitrine-like maneuvering flight among trees. Tail movements are not as readily observed during the flapping flight of the cormorant. Braking action by the tail is important in both species. Both fan the tail out prior to landing. The cormorant uses the tail as an air-brake immediately before a water-landing. It also uses it as a water-brake, dragging it in the water often immediately before, as well as after the rest of the body touches the surface. The Anhinga does not ordinarily make water-landings. On one which was observed, however, the tail was held at a slight angle below the horizontal, and it touched the water slightly before the belly of the bird did; this was almost a full-stall landing, however, and the tail was not dragged in the water for some distance as in the cormorant landings. Motions of the tail made while the Anhinga is standing on, and moving along its perches, suggest the tail's importance as a balancing organ. The tail may also be spread against the foliage in a manner which suggests its use as a support.

Stolpe (1932: 222) described the use of the tail in swimming by *Phalacrocorax*. I do not believe that the Anhinga makes similar use of its tail. Observations of swimming birds indicated that the tail, slightly fanned, follows loosely behind the body and is not moved in a manner suggestive of steering. In discussing this difference in use of the tail, two factors should be considered. The rectrices of the cormorant are short and have narrow vanes, and the rachises are of considerable caliber. They seem well adapted for use as control surfaces under water. The rectrices of the Anhinga are much longer, the vanes are comparatively wide and flexible, and the rachises have a much smaller diameter than those of the cormorant. The structure of the rectrices of the Anhinga does not suggest their use as steering surfaces in swimming. In addition it should be noted that

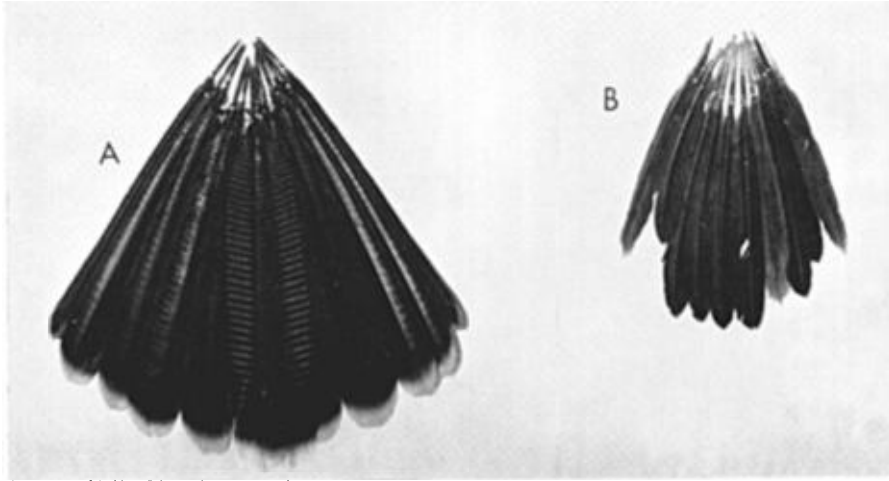

Figure 19. Dorsal view of the tail of the Anhinga (A) and the cormorant (B). The fifth pair of rectrices of the cormorant is not fully grown.

the cormorant molts its rectrices in alternation. In the Anhinga the rectrices are molted practically at the same time; this would leave the individual handicapped if it were dependent upon its tail in underwater progression.

The outer webs of the central pair of rectrices are transversely grooved in the Anhinga. These rectrices have been variously described as being "corrugated," "fluted," "ribbed," and "crimped." Similar corrugations are found on the longest pair of scapulars. Surprisingly little is to be found in the literature concerning the possible functional significance of these. At certain angles, sunlight is reflected from the corrugations, and they become conspicuous against the dark background of the rest of the tail. These corrugations may well be a part of the striking adornments of the Anhinga which function as visual releasing mechanisms during courtship. A second hypothesis of the significance of these corrugations may be introduced. Anhingas flying low over the nesting areas may be observed, with some regularity, to give their tails a characteristic and to my observations stereotyped wriggling or shaking. That there may be production of sound during this tail motion is a possibility that needs careful investigation. Regardless of the manner in which these corrugations may function, they have a definite correlation with courtship and breeding periods. The grooves are not prominent in juvenal rectrices. They are most prominent in the rectrices gained at the prenuptial molt. As these rectrices age, the corrugations flatten until they become rather indistinct, particularly along the distal half of the vanes.

Freshly-molted rectrices have a white terminal border and a brown sub-terminal one. The white and part of the brown band become lost through wear. This emphasizes the fact that length and area of the tail are seasonally variable. The extent to which a feather is worn cannot be determined from the amount of the brown band which is present, because the rectrices fade

with age and the brown area becomes more extensive proximally than in the fresh feather. Because of this wear of the rectrices and because molting may take place in any of several months in south Florida, sexual dimorphism in tail length is difficult to determine.

Simultaneous molt of remiges and rectrices does not take place in *Phalacrocorax* (Heinroth, 1898: 106, 116). Lewis (1929: 58) wrote of irregular replacement of remiges in the cormorant, differences in the replacement of remiges of the two wings being evident. Specimens I have examined show that irregular, often unilateral molt of both remiges and rectrices occurs.

It is a curious fact, despite certain references to the contrary, that ornithologists were generally unaware until rather recently that simultaneous molt of the remiges (often at the same time as that of the rectrices) occurs in the genus *Anhinga*. I can find no mention of molt in, for example, Audubon (1838), Newton and Gadow (1893-1896), Beddard (1898), Sharp and Ogilvie-Grant (1898), and Coues (1927). More recently, such authorities as Chapman (1930) and Howell (1932) failed to mention such molt. Indeed, Bent (1922: 33) stated that although he had observed anhingas with fresh remiges he had never seen them in molt.

However, Chapin (1932: 410) mentioned observations of simultaneous molt in anhingas in zoos, and he described a specimen of the Old World species, collected in the wild, which lacked remiges. Friedmann (1930: 16) described a specimen collected in Ethiopia that lacked remiges, and he quoted E. A. Mearns to the effect that such molt must be characteristic of *Anhinga*. Blake (1956: 31) quoted Heinroth (1898) as authority for stating that such molt occurs in the genus.

I can find no references to observations of flightless anhingas in their natural habitats. It has been my experience that birds about to molt and those already flightless become exceedingly retiring and alert. Such birds do not usually climb high above the water and when they are alerted they usually slip quietly into the water instead of diving from a height. This behavior, coupled with the fact that molt takes place on the wintering grounds, accounts in large part for the general lack of information regarding the flightless condition.

Birds approaching this molt can often be recognized by the ragged, frayed condition of the remiges and rectrices (Fig. 20) and by the brownish color which these feathers acquire. In my observation it appears that the rectrices are replaced simultaneously, or very nearly so, and that this replacement may take place at approximately the same time as the molt of the remiges. But one observes individuals in which the central pair of rectrices has been replaced at an obviously later time than the others. A bird I collected in August (Fig. 20), which has unworn and thus newly replaced remiges, is in this condition. The central pair of remiges, although somewhat worn, is obviously of much more recent acquisition than the remaining ones. It would seem that in this specimen rectrices 2 through 6 are probably juvenal ones, the central pair having been replaced at a prenuptial molt. Wear of the central pair suggests the interesting possibility that the bird may have bred, or have been a potentially breeding bird the season past.

Anhingas characteristically spread their wings and tails and remain in this attitude for considerable lengths of time after emergence from the water. Molting Anhingas, with the remiges barely or not at all visible,

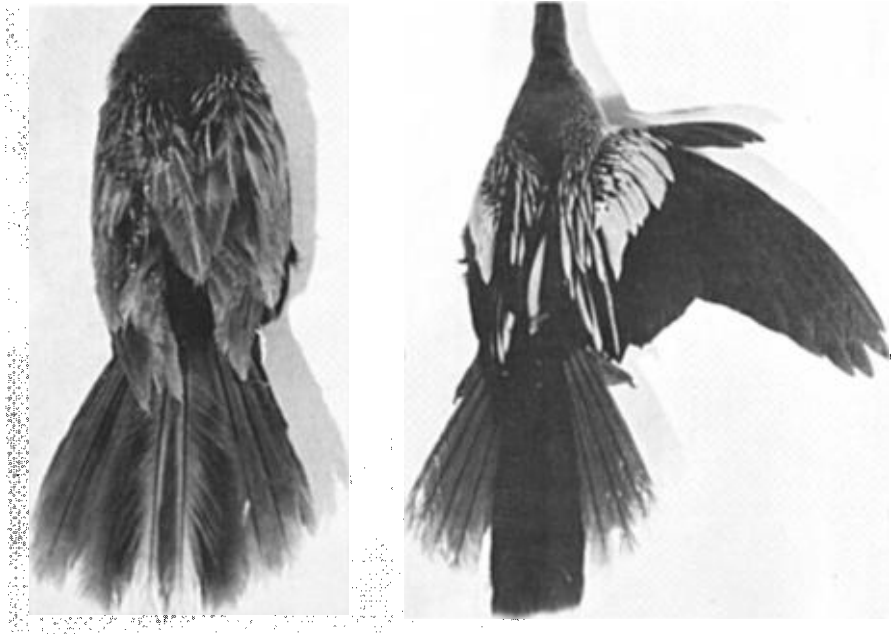

Figure 20. Study skins of the Anhinga showing (*left*) the frayed, faded condition of the remiges and rectrices prior to molt and (*right*) remiges which have been newly acquired and rectrices which were about to be molted. In the specimen at the right, the central pair of rectrices is worn but has been replaced more recently than the remaining ones.

spread their stubs of wings after emergence and remain in such poses, moving about in the sun as do adults in full-feather.

Osteology of the Tail.—In both species the maximum number of free caudal vertebrae, exclusive of the pygostyle, was found to be seven. Seven specimens of each species were examined. In four cormorants and in one Anhinga the centrum of the first free caudal vertebrae was fused in whole, or in part, to the centrum of the most posterior synsacral vertebra. In two cormorants, the tips of the transverse processes of the first free caudal vertebra were fused with the ilio-caudal processes. In two of the Anhingas, the last caudal vertebra was fused to the pygostyle.

There are differences in size and modification of the free caudal vertebrae in the two species. In the Anhinga, the transverse processes of the first free caudal vertebra usually abut the ilio-caudal process; in the cormorant the transverse processes of the two anterior free caudal vertebrae abut this process. In the cormorant, the distal one-half, or so, of the transverse processes of the third and fourth free caudal vertebrae are turned downward. In the Anhinga, the extreme distal ends of the transverse processes of the second, third, and fourth free caudal vertebrae are turned slightly downward. In both species, the transverse processes are largest on the fifth vertebra; the processes of the sixth vertebra are only slightly less extended but are considerably reduced in diameter. Only vestiges of trans-

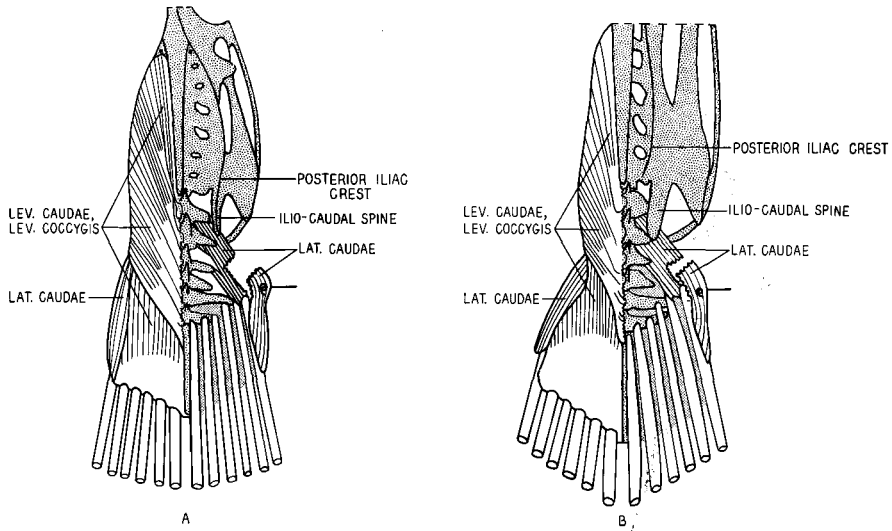

Figure 21. Dorsal view of a superficial (*left*) and a deep (*right*) layer of muscles of the tail of the Anhinga (A) and the cormorant (B).

verse processes are found on the seventh vertebra. In both species indications of haemal spines are found on the second and third vertebrae; these are well-developed on the fourth, fifth, and sixth vertebrae and are longest on the seventh vertebra. The caudal vertebrae of the cormorant are more robust than those of the Anhinga.

The length of each free caudal vertebra was measured through its centrum. In four specimens (two males, two females) of each species, the average of the sum of the lengths of the free caudal vertebrae, exclusive of the pygostyle, was 42.1 millimeters (extremes: 34.3 and 48.5 millimeters) in the cormorant and 43.2 millimeters (extremes: 39.2 and 47.6) in the Anhinga. Considerable variation is also characteristic of the length of the pygostyle. Measured from the distal tip of its blade to the articular surface for the last free caudal vertebra, the length averaged 18.9 millimeters in the Anhinga (extremes: 16.5 and 22.4) and 24.0 millimeters (extremes: 22.7 and 25.2) in the cormorant. The combined length of the free caudal vertebrae is thus very nearly the same in the two species, but the pygostyle is apparently longer in the cormorant. In proportion to body weight, the length of the free caudal vertebrae is greater in the Anhinga, that of the pygostyle in the cormorant, while the combined lengths of the two measurements are very nearly the same in the two species.

Important muscles originate from the depressions upon each side of the synsacral crista. The lateral margins of the depression are formed by the posterior iliac crests (Fig. 21). These are considerably more elevated and divergent in the Anhinga. At the widest point of divergence, the average distance between the crests was 24.1 millimeters in 11 Anhingas (six males, five females) and 16.7 millimeters in six cormorants (four males, two females). The transverse processes of the synsacral vertebrae

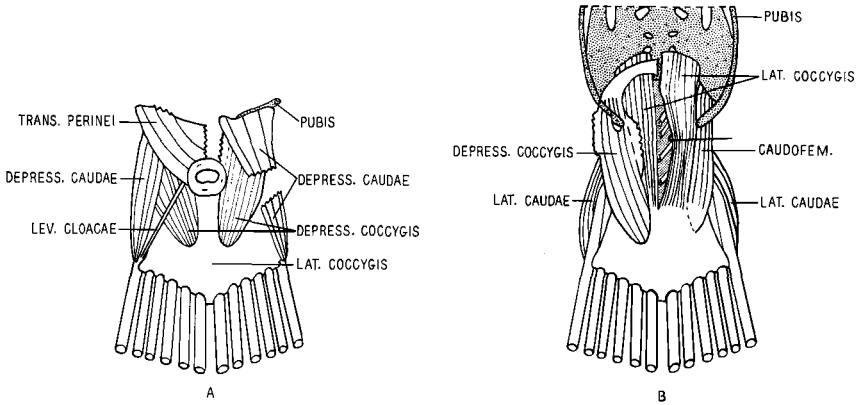

Figure 22. Ventral view of a superficial (*left, A*) and second layer (*right, A*) and a third (*left, B*) and fourth (*right, B*) layer of muscles of the tail of the Anhinga.

are considerably wider in the Anhinga and have relatively small interdiapophysial foramina, thus affording additional area of origin.

The caudal skeleton of the Anhinga is a relatively longer, less robust, and probably more flexible series of free caudal vertebrae than that of the cormorant. The area of origin of caudal muscles from the synsacrum is wider in the Anhinga, thus allowing force to be exerted upon the tail from more lateral positions. In the cormorant the tail skeleton is probably less flexible but more robust. The greater length of the blade of the pygostyle is correlated with the stouter, wider rachises of the rectrices, the central pair of which is anchored upon the blade.

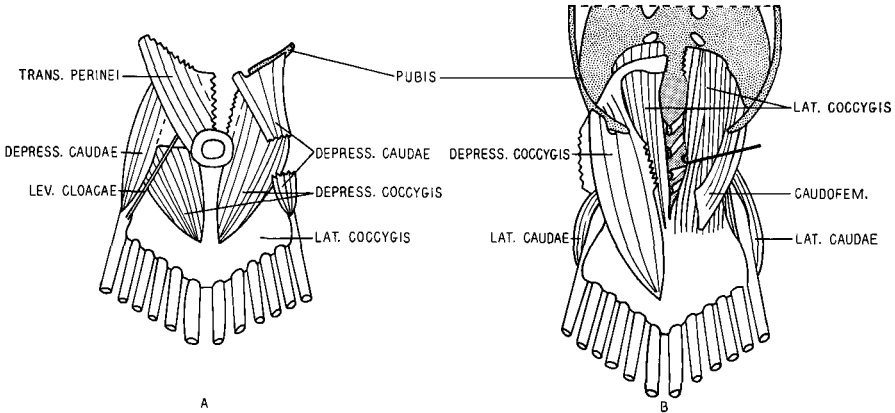

Figure 23. Ventral view of a superficial (*left, A*) and a second layer (*right, A*) and a third (*left, B*) and fourth (*right, B*) layer of muscles of the tail of the cormorant.

Muscles of the Tail.—These descriptions are based upon specimens with seven free caudal vertebrae in addition to the pygostyle. Since the number of caudal vertebrae is not constant, variations from the descriptions of these muscles are to be anticipated. Some such variations are described.

The muscle descriptions are based upon dissections of four specimens (two males, two females) of each species. Measurements of volume were made as described for the Myology of the Wing (page 14).

MM. ADDUCTOR RECTRICUM

General.—The considerable amount of oil-gland material ramifying through the muscles and connective tissues both ventral and dorsal to the rectricial quills makes determination of the extent of these muscles difficult.

A superficial layer of fascia containing anterolaterally directed, weak muscle fibers is found on both dorsal and ventral surfaces. The largely fascial attachment is made to the follicles of the underlying quills. The fascial origin is from the follicles of the individual quills and apparently from the pygostyle as well.

A deep, fleshy layer passes from quill to quill. The first such division originates from the follicle of rectrix I and inserts upon that of rectrix II. As with the superficial layer, this layer is weakly developed along the central portions of the lengths of the enclosed quills, particularly so between quills of rectrices IV and V and V and VI. Moderate development occurs at the distal ends of the enclosed quills.

Action.—Abduction of the lateral rectrices; strengthening of the tail fan.

Comparison.—Intraspecific variation makes comparison between the two species almost impossible. The superficial layer of fascia and scattered muscle fibers may be somewhat better developed in the Anhinga.

M. LEVATOR COCCYGIS AND M. LEVATOR CAUDAE

General.—These muscles are represented by seven considerably fused fasciculi (Fig. 21). Fasciculus VII (fasciculi are designated from anterior to posterior) probably represents *M. levator caudae*. The fasciculi originate lateral to the synsacral crista and from transverse processes of the free caudal vertebrae. The muscle fibers pass caudomesially and insert upon the free caudal vertebrae, the pygostyle, and the follicles of the upper tail coverts and the rectrices. The obliquely-directed caudal margin of each fasciculus lies superficial to the cranial portion of the fasciculus caudal to it.

Origin.—Fasciculi I through VI take largely fleshy origin from the mesial surface of the posterior iliac crest and at this level from the dorsal surfaces of the transverse processes of the fused synsacral vertebrae and the lateral surfaces of the synsacral crista (Figs. 24, 25). The origin may extend forward to the most posterior portion of the anterior iliac crest and adjacent transverse processes. Fasciculus VII takes largely fleshy origin from the transverse processes of the most posterior fused synsacral vertebra, the adjacent surfaces of the synsacral crista and posterior iliac crest, the dorsomesial surface of the ilio-caudal spine, the dorsal surfaces of the transverse processes of the first four free caudal vertebrae, the lateral surfaces of the centra of the vertebrae, and the lateral surface of much of the neural spine of the first free caudal vertebra (Figs. 24, 25).

Insertion.—Fasciculus I inserts by a weak tendon upon the anterolateral portion of the neural spine of the first free caudal vertebra. This insertion may be well developed even if this vertebra is fused to the synsacrum. In one specimen the fasciculus and its insertion were poorly developed. The main insertion of fasciculi II through V is upon the dorsolateral and apical surfaces of the neural spine of the second through fifth free caudal vertebrae, respectively. Cranial to and caudal to insertion upon the neural spine, tendons of opposite sides fuse and are more or less applied to the underlying *Mm. interspinales*. Immediately proximal to the caudal point of insertion upon each side of the neural spine, a tendon is given off which inserts upon the anterior anapophysis of the next caudal vertebra. The tendons of fasciculi II through V increase in width and areas of insertion and fusion in order of their numerical designations. Fasciculus VI: distal to its fusion with the tendon of the opposite side, it has a broad insertion upon the whole of the anterior surfaces and apices of neural spines of free caudal vertebrae VI and VII and upon the apex of the cranial end of the blade of the pygostyle. Fasciculus VII: a heavy sheet of fascia forms and passes to the cranial ends and dorsal surfaces of the enclosed rectricial quills. This fascia continues over the dorsal surface of the oil-gland tissue and inserts upon the coverts and rectricial quills I through V somewhat

proximal to their emergence from the body. Rectrix VI may be weakly inserted upon. The insertions upon the tail skeleton are shown in Figures 24 and 25.

Action.—With simultaneous contraction of both sides of the muscle, the tail is elevated. With unilateral contraction, the tail is elevated upon the side of contraction. Unilateral contraction of the anterior fasciculi would also tend to draw the tail laterally and tilt it.

Comparison.—The volume of the muscle is similar in the two species (Table 12). In the Anhinga, the area of origin is wider and more extensive, the posterior iliac crest being more elevated and more divergent. In the cormorant, the fasciculi are fused to a greater extent, they do not overlap as much as they do in the Anhinga, and the tendons of insertion are shorter and form more distally along the belly. The dorsal surface of the posterior portion of the muscle is covered by a tough aponeurosis, which attaches to the neural spines. To this aponeurosis the inserting tendons of the fasciculi are more or less fused. This aponeurosis is considerably better developed in the cormorant.

Discussion.—The wider area of synsacral origin in the Anhinga indicates greater ability to draw the tail laterally and, with unilateral action while the tail is in certain positions, rotate it. This and the greater degree of independence of the fasciculi and their longer tendons indicate that the muscle in the Anhinga is better able to effect the minute adjustments of the tail which must be made in soaring or maneuvering flight. The narrow, more mesial area of origin of the muscle in the cormorant, the greater fusion of the fasciculi, the shorter tendons of insertion, and the greater development of the aponeurosis along the dorsal surface of the muscle are features which indicate a massive, more unidirectional power of elevation.

M. LATERALIS CAUDAE

General.—The distal two-thirds of this muscle is superficial upon the laterodorsal aspect of the tail musculature (Figs. 21–23). The distoventral surface of the belly is contiguous to, and may be fused weakly with, the belly of *M. depressor caudae*.

Origin.—Mixed, from the mesioventral surface and apex of the ilio-caudal spine, the ventral surface of the transverse process of the first free caudal vertebra, the distoventral surfaces and the caudal surfaces of the second and third free caudal vertebrae (Fig. 24). Origin may also be taken from the fourth free caudal vertebra.

Insertion.—Fleshy and tendinous upon the dorsal surface of the length of the follicle of rectrix VI and the lateral surface of the distal half of the follicle. A weak insertion may extend onto the dorsal surface of the quill of rectrix V.

Action.—Abduction of the rectrices with slight rotation and elevation of the lateral rectrices.

Comparison.—The volume of this muscle relative to the total volume of the caudal muscles tends to be slightly greater in the Anhinga (Table 12). The belly of the muscle is longer in the Anhinga, and the insertion extends for a greater portion of the length of the follicle than it does in the cormorant. In the latter the caudal margin of the belly, as it sweeps laterad from origin on the transverse processes of the caudal vertebrae, has strong fascial connection to the cranial ends of the enclosed quills; such connection is relatively weak in the Anhinga.

Discussion.—Modifications of the muscle in the Anhinga may be correlated with use of the tail in effecting the constant adjustments in soaring and maneuvering flight.

M. DEPRESSOR CAUDAE

General.—The origin and cranial half of the muscle lie deep to *M. transversus perinei*. The distal half is superficial upon the ventrolateral aspect of the tail (Figs. 22, 23). The mesial border of the muscle is connected to the cloacal musculature by stout connective tissues. The distodorsal surface of the belly is contiguous with, and variably, but weakly, fused with, the belly of *M. lateralis caudae*.

Origin.—Fleshy from the outer surface of a portion of the length of the post-ischial pubis (Fig. 24) and mesial to this from fascia of the body wall lying cranial to the cloaca.

Insertion.—Fleshy upon the ventral and ventrolateral surfaces of the follicle of rectrix VI. The insertion extends two-thirds the length of the enclosed quill. The insertion may extend onto the follicle of rectrix V.

Action.—Simultaneous contraction of the bellies of opposite sides depresses the tail. Unilateral contraction depresses and tilts the tail towards the side contracted.

Comparison.—The relative volumes of the muscles are approximately the same in both species (Table 12). In the Anhinga the area of origin from the pubis is slightly more extensive, the area of insertion upon the follicle of rectrix VI is larger, and the fascial attachment to the cloacal musculature is more extensive.

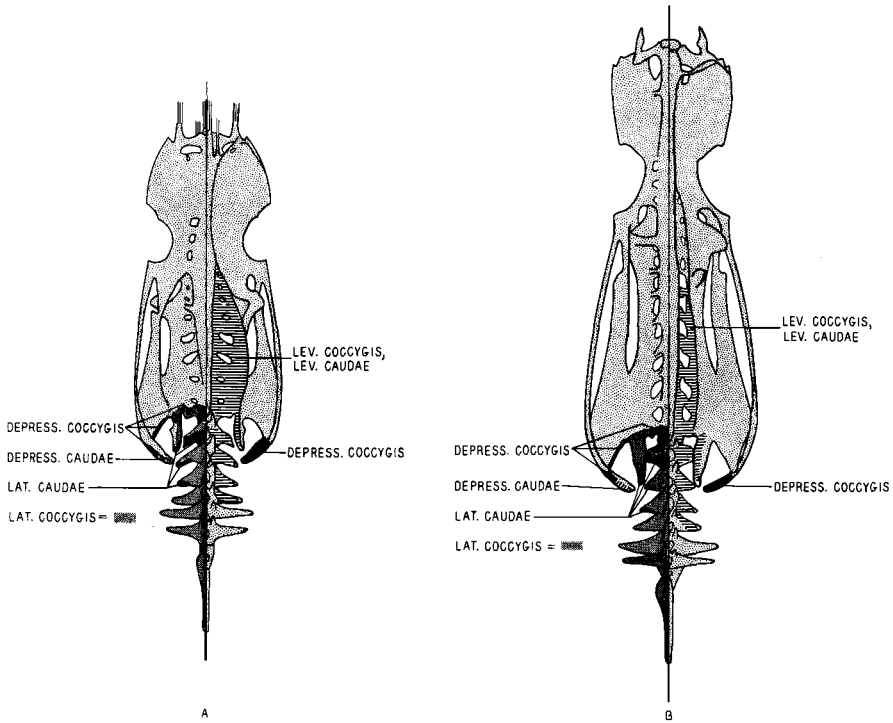

Figure 24. Ventral (left) and dorsal (right) views of origins and insertions of muscles of the tail of the Anhinga (A) and the cormorant (B).

Discussion.—The more extensive areas of origin and insertion of this muscle in the Anhinga indicate that more variable movement of the tail is effected by it; again this is probably to be correlated with the frequent changes in tail position necessary in soaring and maneuvering flight.

M. LEVATOR CLOACAE

General.—This is an extremely small muscle, which passes from the ventral surface of the caudal edge of *M. transversus perinei*, just proximal to the latter's insertion upon the cloacal musculature, to the follicle of rectrix VI (Figs. 22, 23). The muscle parallels the mesial surface of *M. depressor caudae*.

Origin.—From the ventral surface of the caudal edge of *M. transversus perinei* or from fascia connecting to the latter muscle.

Insertion.—By a very weak tendon to the ventral surface to the follicle of rectrix VI. In one specimen the insertion was upon the ventrolateral surface of the follicle of rectrix V. (The tendon of insertion is so fine that it is difficult to expose without destroying or damaging it.)

Action.—Its action must be very weak. Presumably it draws the cloacal musculature backward and slightly laterally.

M. DEPRESSOR COCCYGIS

General.—This stout muscle passes from the pelvic girdle—to the level of the pygostyle (Figs. 22, 23). The caudal portion is in superficial view of the ventral surface of the tail. *M. caudofemoralis* parallels the anterior portion of the muscle's dorsolateral surface.

Origin.—Largely by a very short aponeurosis from the proximal half of the caudal-facing

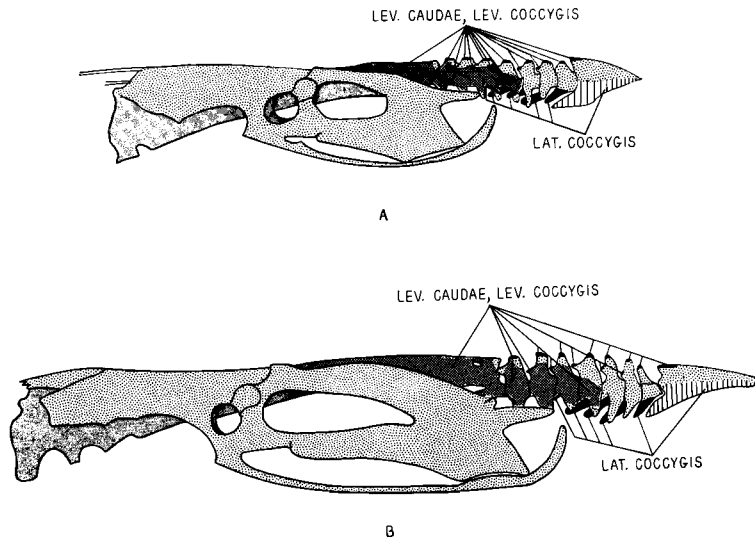

Figure 25. Lateral view of origins and insertions of muscles of the Anhinga (A) and the cormorant (B).

blade of the post-ischial pubis and from the greater length of the cranial-facing blade of the pubis; from the edge of the ischium and narrowly from the latter's ventral (variably dorsal) surfaces extending from the ischial angle to the ilio-caudal style; by a wide aponeurosis from the ventral surface of the centrum of the last fused synsacral vertebra, this aponeurosis being continuous, in part, with that of the opposite side. Strong fascial connections pass from the mesial surface of *M. flexor cruris lateralis*. The origins are shown in Figure 24.

Insertion.—Upon the tough fascia of the ventral surface of *M. lateralis coccygis* (Figs. 22, 23).

Action.—Supplements that of *M. lateralis coccygis* and depresses the cloaca.

Comparison.—The relative volumes of the muscle are very nearly the same in the two species. The insertion continues to a more distal point in the cormorant.

Discussion.—See the discussion under *M. lateralis coccygis*.

M. LATERALIS COCCYGIS

General.—This is the deep muscle of the ventral surface of the tail (Figs. 22, 23). It is composed of a number of more or less fused fasciculi, which form a large mass of muscle extending from the synsacrum to the pygostyle and the rectrices. The bellies of the opposite sides converge and fuse at the level of the fifth free caudal vertebra; cranial to the latter the bellies of opposite sides are united by heavy fascia. The distoventral surface of the muscle is covered by a tough aponeurosis, which attaches to the ventral edge of the pygostyle and to the ventral surfaces of the follicles of rectrices I through VI. *Mm. depressor caudae* and *caudofemoralis* insert upon, and originate from, respectively, the ventral surface of the muscle. *M. lateralis caudae* is closely applied to the dorsolateral surface of the cranial portion of the belly. Considerable glandular material is scattered throughout the distal portion of the muscle.

Small, deep divisions of the muscle, described under various names, but considered as portions of this muscle by Fisher (1946: 663), pass between the free caudal vertebrae and to the pygostyle.

Origin.—Fleshy from the proximal two-thirds of the ventromesially facing surface of the ilio-caudal spine; the origin also includes the transverse processes of the last fused synsacral vertebra. Fascial connections are made to the centrum of the latter vertebra. There is also a fleshy origin from the ventral surfaces of the transverse processes of the first six free caudal vertebrae mesial to the areas of origin of *M. lateralis caudae* and from

TABLE 12
 VOLUMES OF THE CAUDAL MUSCLES OF THE ANHINGA AND THE CORMORANT EXPRESSED AS
 PERCENTAGES OF THE TOTAL VOLUME OF CAUDAL MUSCLES¹

Muscle	Anhinga		Cormorant	
	Extremes	Mean	Extremes	Mean
levator coccygis				
levator caudae	29.24-34.12	30.88	30.77-33.92	32.03
lateralis caudae	6.81- 9.37	8.0	5.49- 7.69	6.74
depressor caudae	7.80-10.07	9.28	8.57- 9.99	9.37
depressor coccygis	17.60-21.25	20.11	18.73-21.95	20.35
lateralis coccygis	26.92-34.11	31.74	30.71-32.99	31.49

¹ Based on two males and two females of each species. *M. caudofemoralis* not included.

the centra and haemal spines of the free caudal vertebrae. The origins are shown in Figures 24 and 25.

Insertion.—Tendinous upon the apices of the haemal spines of the fourth through seventh free caudal vertebrae. The smaller, deep divisions insert upon the centra and non-apical portions of the haemal spines of these vertebrae. There is also a tendinous insertion upon the length of the ventral surface of the pygostyle and a fleshy insertion upon the ventral half of the lateral surface of the pygostyle's blade. The lengths of the ventral surfaces of the follicles of rectrices I through V are covered by this muscle; the insertion may extend onto the ventromesial surface of the follicle of rectrix VI. The lower tail coverts have their bases buried in the aponeurosis covering the muscle. The insertions upon the skeleton are shown in Figures 24 and 25.

Action.—Powerful depressor of the tail. Unilateral contraction of bellies depresses the tail on the side contracted; the stout connections between the bellies of opposite sides must reduce the force of unilateral contraction, however. Contraction of *M. depressor coccygis* contributes to action of the muscle.

Comparison.—The relative volumes are very nearly the same in both species (Table 12). Fusion of the bellies of opposite sides occurs more proximally in the cormorant. The area of insertion of *M. depressor coccygis* upon this muscle is slightly more extensive in the cormorant than it is in the Anhinga.

Discussion.—The cormorant uses its tail as a water-brake during landing and apparently for steering during swimming. The greater degree of fusion of opposite bellies and the greater area of insertion upon the muscle by *M. depressor coccygis* would seem to be modifications which produce a powerful, largely unidirectional force upon the tail. The Anhinga uses its wide tail as an air-brake prior to landing. Depression of the tail is probably important during soaring flight as well, and Fisher (1946: 632) believes that the development of this muscle may be correlated with soaring flight and the necessity of bracing the tail against the upward force exerted upon it during soaring.

MM. INTERSPINALES

General.—These are small muscles passing between the neural spines of the caudal vertebrae. The first division originates from the lateral and posterior edges of the synsacral crista and inserts upon the anapophyses and anterior edge of the neural spine of the first free caudal vertebra. From the latter vertebra and from succeeding caudal vertebrae, the origins are from the caudal half of the lateral surfaces of the neural spines. Insertions are upon the cranial half of the lateral surfaces of the neural spines, the anterior anapophyses, and the anterior edge of the neural spines of the first five free caudal vertebrae. The insertion upon the pygostyle, which is upon the dorsal third of the anterior edge of the blade, is weak and more or less tendinous.

The dorsal surfaces of these muscles are fused to the tendons of insertion of *Mm. levator coccygis* and *levator caudae*.

Action.—These muscles assist in elevating the tail and in maintaining the relative positions of the vertebrae.

Comparison.—The divisions are possibly somewhat better developed in the cormorant. In both species the anterior divisions are of greater bulk and extent than are the posterior divisions.

Summary and Conclusions.—The long tail of the Anhinga provides a surface area approximately two and one-half times greater than that of the cormorant. This large area complements the wings in supplying lift; it serves as a control surface important in maneuvering flight and as a braking surface; it functions as a balancing organ during perching and aboreal progression of the Anhinga. The structure of the vanes and rachises, simultaneous molt of flight feathers, and observations of swimming birds support the belief that the tail is not used actively in swimming by the Anhinga. The structure of the rectrices is not contradictory to the belief that the tail is so used by the cormorant. The corrugations of the outer vanes of the central pair of rectrices are believed to function in display; light reflected from these corrugations contrasts with the dark background afforded by the remainder of the vane. Sound production by the corrugations is not an impossibility.

Although observations of molting, flightless birds in the wild have been recorded in the literature, simultaneous molt of remiges and rectrices of the Anhinga was not generally recognized by ornithologists. Molting birds become shy, and their actions tend to make them inconspicuous. There is probably a prenuptial molt of first-year Anhingas, in which only the central pair of rectrices is replaced. The rectrices are usually shed nearly simultaneously and at very nearly the same time as the remiges.

The maximum number of free caudal vertebrae in each species was found to be seven. This number is variable; the first vertebra may be fused with the synsacrum and the seventh vertebra may be fused with the pygostyle. The combined lengths of the free caudal vertebrae are nearly equal in the two birds, but they are longer in proportion to the length of the synsacrum in the Anhinga. The length of the pygostyle is greater in the cormorant. The synsacral areas from which caudal muscles originate are considerably different in the two species. Those of the Anhinga are probably greater in comparative area, and they are considerably wider. In the Anhinga these modifications are indicative of a tail capable of more intricate movements and of greater lateral motion than in the cormorant. In the latter, skeletal features indicate more powerful action of the tail but more restricted motion than in the Anhinga.

Muscle patterns of the tails of the two species confirm the indications of motion afforded by the skeletal features. Those muscles principally effecting dorsal and ventral motion of the tail, *Mm. levator coccygis*, *levator caudae*, *depressor coccygis*, and *lateralis coccygis*, are of approximate equal relative volume in the two birds. These muscles themselves, however, are capable of producing more intricate and more lateral motion in the tail of the Anhinga, and they are relatively unidirectional in the force they produce in the cormorant. The tail muscles of the two species, then, are modified, respectively, to facilitate soaring and maneuvering flight in the Anhinga, and to provide the power necessary for elevation and depression of the tail coincident with heavy flapping flight, braking during water landings and probably with underwater maneuvering in the cormorant.

THE LEG

SWIMMING

The Anhinga and the cormorant are apparently not dependent upon their feet to the same extent in swimming. They have different methods by which they land upon, or enter, the water. They differ in the extent to which they swim at the surface. Both fish submerged, but they are differently adapted for fishing. The Anhinga exhibits more pronounced modifications for living in an arboreal habitat than does the cormorant.

The cormorant usually makes a coasting, belly-landing upon the water, frequently braking upon the surface with its tail before the rest of the body touches the water. Anhingas may dive into the water from an overhanging perch, or they may crawl down to the water and submerge directly or launch out upon the surface. It is unusual for them to make a belly-landing from flight; if this is done, it is after a short, gliding flight from a nearby perch. Very rarely Anhingas may dive into the water from flight. The few observations I made of this behavior were of birds thrown into sudden alarm to which the initial reaction was flight; the reaction to dive was apparently a secondary one, flight seeming insufficient for escape. These dives were poorly coordinated.

It has been my observation that Anhingas ordinarily spend little time swimming at the surface. Surface swimming is restricted to short intervals between dives, periods when fish are dislodged from the mandibles and swallowed, cautious reconnoitering when there are disturbances in the vicinity, or during scouting for a place of emergence. Observations of nesting birds indicate that when an Anhinga finishes fishing, it often swims submerged, rather than at the surface, to the foot of the nesting tree. When at the surface, Anhingas usually swim low in the water with only the head and a portion of the neck emergent. Cormorants spend much time swimming at the surface. Large groups of cormorants may be observed on the shallow waters bordering the Florida Keys. Here they may remain for hours. Intermittently they dive, but much of the time is spent at the surface. They swim with back and shoulders emergent, and one gains the impression that they are considerably more buoyant than Anhingas. While at the surface, cormorants frequently submerge the head as though looking or listening for something below. Anhingas rarely do this.

Stolpe (1932: 222) found that cormorants differ from other diving birds in that while swimming, their feet are held ventral to the posterior end of the body rather than lateral to it. The similar positions of the antitrochanter and the femur, the apparent lack of latero-mesial motion at the tarsal joint, and other anatomical similarities, suggest similar positioning of the feet in the Anhinga. I have not observed the position of the feet clearly in either species while they were swimming.

According to Audubon (1838: 143), a swimming cormorant uses its feet simultaneously and an Anhinga uses its feet simultaneously or alternately. I am unable to confirm these observations. While swimming at the surface or partly submerged, Anhingas often advance by a regular series of bobbings. These bobbings may be produced by simultaneous action of the feet.

Conflicting opinions exist on the use of the wings during underwater swimming. Lewis (1929: 74) reviewed numerous reports of such in the Double-crested Cormorant. Although he never observed use of the wings in swimming, he concluded that evidence for it was so strong that he could not doubt it. Read (1909: 166) reported use of the wings by submerged Anhingas. Audubon (1838: 143) stated that the wings are held partially spread, but are not used in propulsion. I have observed many Anhingas while they were prowling for food in shallow situations where their dorsal surfaces were visible. Although the wings are held incompletely folded and give the impression of being loosely held between the shoulders and the elbows, I have never seen any indication of their active use in swimming. I have pursued wounded birds which were seeking escape under water; these were not seen to use their wings. Anhingas swim through and around aquatic growth which would seriously interfere with any wing motion. The myology of the wing and the small diameter of the rachises of the remiges as well as the lengths and widths of their vanes are modifications which would poorly adapt the wing for underwater use. The simultaneous molt of the remiges of the Anhinga might impede the bird in remaining submerged and thus impede its food-getting during this period.

The positioning of the wings and tail of the Anhinga during submergence invites speculation as to possible functional significance of these at this time. I think that wing and tail surfaces function both as stabilizers and as friction-creating mechanisms, which slow down sinking or forward progress through the water. This is probably important in the slow swimming of the Anhinga as it stalks its prey (see page 107).

Both species have still another adaptation which is probably important in submerged swimming. McAtee and Stoddard (1945) and many others have commented upon the fact that the plumage of these birds does not shed, but rather absorbs, water. Although McAtee and Stoddard believed this to be a "hiatus in their adaptation to aquatic life," I consider it an adaptation to reduce buoyancy. This is particularly important during the slow swimming of the Anhinga while it is submerged (see page 107).

When leaving the water, the cormorants make a long up-wind run, flapping vigorously. Close observation shows that both feet strike the water simultaneously. Thus the action of the legs seems to be similar to that purported during swimming. I have observed few attempts by Anhingas to take-off from the water, and these were not successful. The short tarsometatarsus is ineffective in raising the bird from the water, and the long wings have but a slight arc through which they can beat. However, the bird can take off from a submerged position. This is apparently unusual. Meinertzhagen (1935: 146) described such a take-off by the Old World species. "The first one sees," he said, "is the huge bird apparently flying from under the water." I witnessed a similar take-off in a fairly large pond in south Florida, while I was observing the activities of a male Anhinga fishing near its nesting tree. (The female Anhinga was incubating eggs at the time.) The bird surfaced from a dive close to another surfaced male. Both birds immediately submerged and the first Anhinga could be seen, immediately below the surface, in pursuit of the second. The pursued bird suddenly emerged into flight in a great shower of spray. This occurred so quickly and unexpectedly that little of the actual movements were dis-

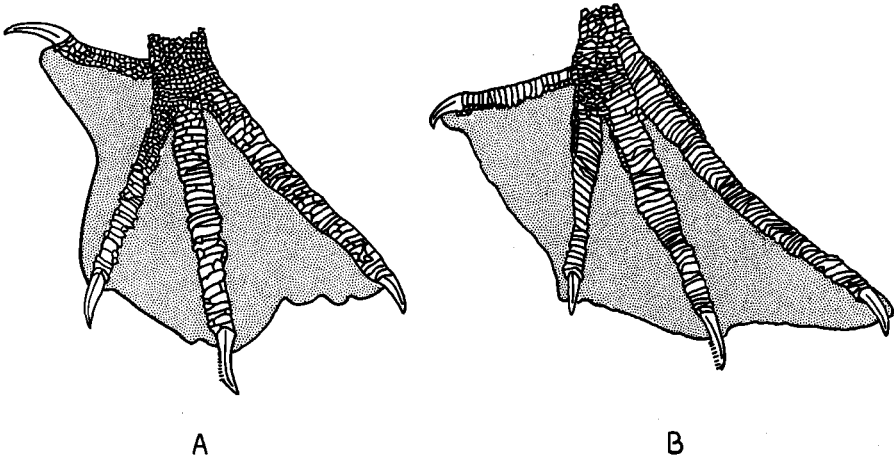

Figure 26. Dorsal view of the foot of the Anhinga (A) and the cormorant (B).

tinguished. It was my impression, however, that the wings were not spread prior to emergence and that the bird did not run along the surface. I believe that it spread its wings as, or immediately after, it broke the surface film and that it rose to a height of a foot or more without flapping. Vigorous flapping then began. I think that the bird, moving rapidly below the surface, acquired sufficient momentum as it passed into the less dense medium to become air-borne without additional effort.

The fact that Anhingas almost invariably place their nests in branches overhanging water is usually interpreted as being advantageous in providing quick escape by diving into the water in event of danger. It may also be regarded as providing ready access to the nesting tree from the water.

Records of Anhingas seen in salt water are scarce. This, I believe, is in large part due to the absence, in marine habitats, of suitable places for emergence from the water, as well as lack of quiet, growth-filled water suitable for the type of fishing the Anhingas usually employ (see pages 106 and 107). Sheltered situations with emergent growth are not common in marine littoral areas. However, where such conditions are found within the range of the Anhinga, there the birds may be found. Anhingas nest commonly in the Red Mangroves of the south-west Florida coast. Here I have often seen them swimming in salt and brackish water. The scarcity of records of the birds in such areas may be due, in large part, to the inaccessibility of these situations.

Anhingas frequent arboreal situations. Lower stories of growth are reached primarily by climbing into them from the water, and secondarily from flight. Upper stories of growth are usually reached by flight. In climbing, both neck and feet may be used. Anhingas may perch for hours grasping small branches in their feet, or they may rest upon the flat surfaces of large branches. Upon broad surfaces they may rest with their feet obscured below them or stretched out behind them. Cormorants alight in trees of varying sizes and even nest in the relatively small Red Mangroves,

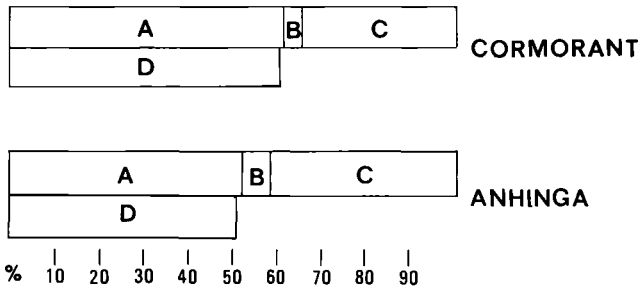

Figure 27. The lengths of the pelvic elements expressed as percent of the length of the pelvis. A = postacetabular ilium; B = acetabulum; C = preacetabular ilium; D = ischium.

Rhizophora mangle Linnaeus, fringing the coastal areas of south Florida. They are less habitually seen in arboreal situations than Anhingas, however. They climb clumsily. They perch commonly upon broad surfaces afforded by rocks, bulkheads, buoys, channel markers, etc. Groups of cormorants are often seen sunning upon banks and exposed sand bars and beaches.

The webbing is reduced in the foot of the Anhinga, particularly between toes I and II (Fig. 26). The hallux is capable of more pronounced opposition to the front toes than in the cormorant, and the nails of the Anhinga are longer and more curved.

OSTEOLOGY OF THE PELVIS AND LEG

The general features of the pelvic girdle and limb of *Phalacrocorax* and *Anhinga* have been described by Shufeldt (1902: 158-159, 163-165, 171, 173-175, 180-182). Boas (1933: 47-48) described pelvises of the two genera.

The following descriptions, unless otherwise indicated, are based upon pelvises of eleven Anhingas (seven males, four females) and six cormorants (four males, two females). All specimens were collected in south Florida. The terminology used is that of Howard (1929: 314-324), with additional terms given by Boas (1933: 33-37, 47-48). The terms "dorsal," "ventral," "anterior," and "posterior" are used with respect to the leg in swimming position at the beginning of the propulsive stroke.

The Pelvis.—The pelvises of the two species differ markedly in the comparative development of the pre- and postacetabular elements (Fig. 27). Pre- and postacetabular iliac lengths were found to comprise 52.6 per cent and 41.8 per cent, respectively, of the total iliac length in the Anhinga and 33.6 per cent and 62.6 per cent, respectively, of the total iliac length in the cormorant (Table 13). (Total iliac length was measured from the most anterior point of the anterior iliac crest to the apex of the ilio-caudal spine.)

The ilio-caudal spine (Fig. 21) is characteristic of the pelvises of both species. In the Anhinga it comprises approximately six per cent more of the total length of the postacetabular ilium than in the cormorant (Table 13). The posterior iliac crest, which terminates anterior to the spine in the cormorant, continues through the length of the spine in the Anhinga. The ilio-caudal spine is three-sided in the Anhinga and thus affords increased area for muscle attachment.

TABLE 13
MEASUREMENTS (IN MILLIMETERS) OF THE PELVIS OF THE ANHINGA AND OF THE CORMORANT¹

Measurement	Anhinga		Cormorant	
	Extremes	Mean	Extremes	Mean
Ilium				
Total length	81.8-86.5	84.2	113.6-133.5	121.4
Preacetabular ilium				
Length	33.4-37.3	35.2	37.8- 43.4	40.8
Greatest width between crests ²	28.7-34.3	31.4	32.6- 37.5	35.2
Postacetabular ilium				
Length	41.8-45.7	44.4	70.4- 84.7	76.0
Length minus length of ilio-caudal spine	31.9-35.3	33.4	58.2- 67.6	61.9
Greatest width between crests	22.5-25.6	24.1	15.4- 18.3 ³	16.5 ³
Ischium				
Length	41.2-45.0	43.6	69.3- 80.7	73.4
Greatest distance between widest ischial points	36.5-42.6	39.8	42.3- 47.0	44.9

¹ Unless otherwise indicated, based on pelves of 11 Anhingas (seven males, four females) and six cormorants (four males, two females).

² Based upon pelves of eight Anhingas (five males, three females) and five cormorants (four males, one female).

³ Based on five cormorants (four males, one female).

In addition to being comparatively longer in the Anhinga, the posterior iliac crest is of considerably greater height; greater area of muscle attachment is therefore afforded by it.

The postacetabular ilium is comparatively wider in the Anhinga than in the cormorant (Table 13). In the former, the greatest width of the postacetabular region is equal to 90.2 per cent of its length; in the cormorant this width is 57.9 per cent of the length. (Postacetabular width was measured between the terminal processes of the ischia.) The greater width of the postacetabular region of the pelvis in the Anhinga is noteworthy.

The pubis is similar in the two species. However, the pectineal process lies ventral to the acetabulum in the cormorant and anterior to it in the Anhinga.

Dabelow (1925: 308) pointed out characteristics associated with adaptation for swimming. These included elongation of the postacetabular elements in comparison with the preacetabular ones and a reduction in width of the postacetabular region. Both of these modifications are considerably more pronounced in the cormorant than in the Anhinga.

The comparative shortness of postacetabular elements in the Anhinga may, to some extent, be compensated for by the increased area of muscle origin afforded by the well-developed posterior iliac crest, which terminates at the distal end of the ilio-caudal process. It is also important to consider that this crest, in effect, provides an increased area of origin for muscles, the axes of which are brought into angles with the insertions, which must result in greater force of muscle action. The significance of the mesial-facing surfaces of the posterior iliac crest of the Anhinga has been discussed in connection with the caudal musculature (page 52). The relative differences in the position of the pectineal process may be correlated with the function of *M. ambiens* (page 84), which originates from it.

TABLE 14
MEASUREMENTS AND PROPORTIONS OF THE FEMUR OF THE ANHINGA AND THE CORMORANT¹

Measurement or Proportion	Anhinga		Cormorant	
	Extremes	Mean	Extremes	Mean
Length in millimeters	54.3-57.9	55.6	55.2-61.4	56.9
Trochanteric crest				
Anterior-posterior width in millimeters	9.1- 9.7	9.3	11.6-12.9	12.2
Width expressed as a percentage of femoral length	16.3-17.4	16.7	20.3-22.6	21.2
Femoral shaft at apex of anterior bowing				
Anterior-posterior width in millimeters	5.0- 6.2	5.7	7.4- 9.1	7.8
Lateral-mesial width in millimeters	6.0- 6.9	6.3	6.1- 7.4	6.4
Combined anterior-posterior and lateral-mesial widths at apex of anterior bowing of femoral shaft expressed as a percentage of femoral length	19.7-23.5	21.6	23.7-28.9	26.7
Distal head of femur				
Width in millimeters	12.3-12.7	12.4	14.8-15.4	15.0
Width expressed as a percentage of femoral length	22.1-22.8	22.3	24.8-25.8	25.1

¹ Based on three males and three females of each species.

The Femur.—Average absolute length of femora of the two species is nearly the same (Table 14); overlap in these measurements was found. Femoral length comprises 22.2 per cent of the total length of the leg elements in the Anhinga and 19.3 per cent of this length in the cormorant (Table 15).

The femur of the cormorant is markedly more robust than that of the Anhinga. In the former, the trochanteric crest is better developed, the popliteal area is more extensive, and the width through the distal head is greater. In the Anhinga, the latero-mesial diameter of the proximal two-thirds or so of the femoral shaft is greater than the antero-posterior diameter; the reverse of this is true of the cormorant. The femur of the Anhinga, then, tends to be rounded, while that of the cormorant is latero-mesially flattened. Values involving the femur are given in Tables 14 and 15.

Reduction in femoral length and increase in size of the trochanteric crest are adaptations for swimming (Dabelow, 1925: 308). Digital flexors important in the power-stroke in swimming originate from the popliteal area. The rotular groove cannot be held indicative of the degree of terrestrial progression in these species since major insertions in this area are made upon the large patellar surfaces.

The Tibiotarsus and the Fibula.—The mean length of the tibiotarsus of the Anhinga is 87 per cent of that of the cormorant (Table 16), yet this leg element constitutes very nearly the same percentage of the total length of the leg elements in the two species (Table 15). It is significant, however,

TABLE 15
THE LENGTHS OF THE LEG ELEMENTS OF THE ANHINGA AND THE CORMORANT EXPRESSED AS
PERCENTAGES OF THE TOTAL LEG LENGTH¹

Element	Anhinga		Cormorant	
	Extremes	Mean	Extremes	Mean
Femur	21.4-22.8	21.9	18.9-19.8	19.2
Tibiotarsus	34.3-35.8	35.1	33.5-34.9	34.2
Patella ²		1.6		4.2
Tarsometatarsus	15.5-16.6	16.1	20.1-20.8	20.4
Digit III ³	23.5-27.7	25.3	21.5-22.4	21.9

¹ Sample size: three males and three females of each species.

² Minimum patellar length.

³ Length of ungual phalanx not included in any of the calculations.

that the postacetabular iliac length of the Anhinga is 47 per cent of that of the tibiotarsus compared with 75 per cent in the cormorant.

The width of the proximal head of the tibiotarsus is only slightly greater in the Anhinga (Table 16). There are considerable differences in the shape and extent of the inner cnemial crest. In the Anhinga this is more extensive, particularly the proximal portion, and it extends farther ventrally. In the cormorant the crest extends farther anteriorly (Table 16). The fibular crest is slightly wider in the cormorant.

In the Anhinga, the distal head of the tibiotarsus is relatively wider (Table 16), and the internal condyle, in comparison to the external one, does not extend as far distally as in the cormorant.

The distal portion of the fibula is comparatively stout in the cormorant, and the apex is ligamentously attached to the tibial shaft. In the Anhinga the part of the fibula distal to the fibular crest is attenuated, does not extend as far distally, and is not attached to the tibia.

The mesial surface of the inner cnemial crest, which is comparatively larger in the Anhinga, serves in large part as origin for *M. gastrocnemius, pars interna*; this muscle is better developed in the Anhinga. There is little significance in comparison of the extent of the inner cnemial crest in the two species, however, since reduction of this in the cormorant is probably compensated for by the enlarged patellar surfaces. In the Anhinga the somewhat larger articulating surfaces, indicated by the greater widths of the distal and proximal heads of the tibiotarsus, may be important as weight-bearing adaptations. Extensors and flexors important in the power-stroke in swimming originate in part from the fibular crest, the adjacent tibial shaft, and the fibula. These muscles are correspondingly reduced in the Anhinga. *M. peroneus brevis*, which originates in part from the distal end of the fibula, is comparatively smaller in the Anhinga (page 92). The elongated inner condyle of the distal head of the tibiotarsus of the cormorant may act as a brace for the tarsometatarsus in opposing the greater force produced by the elongated portion of the webbing between digits III and IV during the power-stroke of swimming. It may also function to offset the force of contraction of the extensors inserting upon the disto-lateral-facing surface of the hypotarsus.

The Patella.—The patella of the cormorant has a large, triangular dorsal surface, elongated lateral and mesial surfaces, and blade-like ventral and

TABLE 16
MEASUREMENTS AND PROPORTIONS OF THE TIBIOTARSUS OF THE ANHINGA AND THE CORMORANT¹

Measurement or Proportion	Anhinga		Cormorant	
	Extremes	Mean	Extremes	Mean
Length in millimeters	86.8-94.8	89.2	95.5-112.8	101.3
Proximal head				
Width in millimeters	9.6-10.5	10.0	10.6- 11.2	10.9
Width expressed as a percentage of tibiotarsal length	10.8-11.7	11.2	10.2- 11.3	10.7
Distal head				
Width in millimeters	10.3-11.0	10.6	10.8- 12.5	11.7
Width expressed as a percentage of tibiotarsal length	11.0-12.4	11.8	11.0- 11.9	11.5
Width in millimeters through tibial shaft and widest point through fibular crest	8.3- 9.6	8.8	10.0- 11.3	10.6
Above measurement as a percentage of tibiotarsal length	9.3-10.7	9.7	9.8- 11.1	10.4
Greatest height in millimeters through internal head and internal cnemial crest	15.5-16.3	15.7	14.7- 17.6	16.1
Above measurement as a percentage of tibiotarsal length	16.8-18.8	17.8	14.1- 17.3	15.8

¹ Based on three males and three females of each species.

anterior borders. The anteroposterior length exceeds the height (Fig. 31). The patella of the Anhinga is dorsoventrally elongate (Fig. 31). It lacks pronounced lateral and mesial surfaces, presenting instead a broad, convex, anterior surface. The dorsal surface is comparatively small. The ventral border is drawn out into a small central process with a small process on each side.

Garrod (1876a: 340) called attention to the patellar foramen for the passage of *M. ambiens* in *Phalacrocorax*. In the Anhinga, the anterior surface of the patella is grooved for the passage of this tendon. I have examined specimens in which this groove, to varying extent, is ossified over; Garrod (*loc. cit.*) noted similar ossification.

Shufeldt (1913: 398-399) stated that the patella of *Phalacrocorax* is formed through the fusion of the true patella and a portion of the cnemial crest. Lewis (1929: 47), however, found no evidence of this. Observations of the development of the patella of the Anhinga apparently have not been made. Functionally it may be regarded, in part at least, as an elongation of the tibiotarsus, since its ventral half serves as an extended area of origin for muscles of the tibiotarsus.

In *Phalacrocorax*, the variable shape of the patella, and the often cancellous nature of its articulating surface, make measurements of it inexact.

TABLE 17
MEASUREMENTS AND PROPORTIONS OF THE TARSOMETATARSUS OF THE ANHINGA
AND THE CORMORANT¹

Measurement or Proportion	Anhinga		Cormorant	
	Extremes	Mean	Extremes	Mean
Length in millimeters	39.4-42.8	41.2	58.0-65.6	60.1
Proximal head				
Greatest width in millimeters	11.2-11.8	11.4	12.1-13.6	13.0
Greatest width as a percentage of tarsometatarsal length	26.1-29.2	27.7	20.4-22.7	21.6
Distal head				
Width through trochleae in millimeters	14.3-15.9	14.9	13.8-15.2	14.5
Above measurement as a percentage of tarsometatarsal length	34.7-38.3	36.1	22.9-25.2	24.1
Tarsometatarsal shaft at level of metatarsal facet				
Greatest width in millimeters	7.6- 8.2	7.8	6.0- 7.3	6.9
Above measurement as a percentage of tarsometatarsal length	18.4-19.7	18.6	9.9-12.1	11.3
Hypotarsus				
Length in millimeters of calcanal surface	5.0- 6.0	5.6	9.2-10.3	9.9
Above measurement as a percentage of tarsometatarsal length	12.1-14.3	13.6	15.3-17.1	16.4
Proximal head including hypotarsus				
Height in millimeters	11.1-11.4	11.3	16.2-17.6	16.7
Above measurement as a percentage of tarsometatarsal length	26.1-28.4	26.9	27.8-28.3	28.0

¹ Based on three males and three females of each species.

The minimum value found of the anteroposterior length of the ventral portion of the patella was taken as the measurement of patellar length. This measurement was twelve millimeters in the cormorant and three millimeters in the Anhinga; these lengths were included as part of the total length of the leg elements.

Extensive skeletal areas anterior to the knee joint are characteristic of many aquatic birds. These areas afford additional surfaces of origin for extensor and flexor muscles of the tarsometatarsus and foot, as well as surfaces of insertion for muscles important in tibiotarsal action. The conspicuous differences in shape and size of the patellas of the two species are indicative of important differences in development and function of the myology of the leg.

The Tarsometatarsus.—The tarsometatarsi of the two species differ to a greater extent than do the other major leg elements. The length of this bone in the Anhinga was found to be but 68.5 per cent as long as that of the cormorant and to constitute approximately four per cent less of the total leg length (Tables 15, 17).

Widths of the proximal and distal heads of the tarsometatarsi give an indication of the more robust nature of this bone in the Anhinga (Table

TABLE 18
MEASUREMENTS AND PROPORTIONS OF METATARSAL I OF THE ANHINGA AND THE CORMORANT¹

Measurement or Proportion	Anhinga		Cormorant	
	Extremes	Mean	Extremes	Mean
Length in millimeters	11.7-14.3	12.8	14.3-16.3	14.8
Length expressed as a percentage of tarsometatarsal length	28.4-34.4	31.0	23.6-27.0	24.6
Distal head				
Width in millimeters	5.7- 6.8	6.2	5.7- 6.2	5.8
Width expressed as a percentage of tarsometatarsal length	44.5-52.3	48.4	41.2-44.8	41.8

¹ Based on three males and three females of each species.

17). Measurements of the hypotarsi (Table 17) indicate somewhat greater development of this important area of muscle attachment in the cormorant. The shaft of the bone is considerably wider through its lateromesial axis than in the cormorant.

There are differences in the positions of the trochleae. In both species the trochlea for digit III lies mesial to the median longitudinal axis of the tarsometatarsal shaft. In the Anhinga, but not in the cormorant, the trochlea for digit II projects more distally than that for digit III, and the trochlea for digit IV is more proximal to that for digit III than in the cormorant. In absolute measurement, the width through the trochleae is greater in the Anhinga than in the cormorant, although the tarsometatarsus is considerably shorter in the former.

The more prominent grooves and ridges of the tarsometatarsus and the greater width of this bone in the Anhinga provide greater area of origin for the short toe flexors, which are important in perching. The differences in trochlear development allow wider spacing and greater mobility of the toes in the Anhinga. These features are important in balance and progression associated with adaptation for an arboreal habitat. The relatively longer tarsometatarsus of the cormorant may be important not only in swimming but in assisting the bird in taking off from the water. The hypotarsus serves as insertion for the muscles producing the power-stroke in swimming; these muscles are larger in the cormorant.

Metatarsal I.—While metatarsal I is essentially similar in both species, there are considerable differences in its proportions (Table 18). The average width through the distal head tends to be greater in the Anhinga, and its length in comparison with that of the tarsometatarsus is greater. In the cormorant a tendinous loop, which contains the tendon of *M. extensor hallucis longus*, crosses the distal head; this loop was not found in the Anhinga. Differences in proportions of Metatarsal I in the Anhinga are correlated with the greater importance of the hallux in perching and climbing.

The Digits.—Differences between the two species are apparent in digital and phalangeal length and in development of the phalanges.

Digital lengths were measured with the cleaned phalanges placed in articulated position; lengths of unguis phalanges were not included. The

TABLE 19
MEASUREMENTS AND PROPORTIONS OF DIGITAL LENGTHS IN THE ANHINGA AND THE CORMORANT¹

Measurement or Proportion	Anhinga		Cormorant	
	Extremes	Mean	Extremes	Mean
Digit I				
Length in millimeters	20.5- 22.7	21.8	23.7- 27.0	24.7
Length expressed as a percentage of the length of digit III	33.9- 37.2	36.1	36.4- 40.6	39.0
Digit II				
Length in millimeters	39.5- 44.5	42.3	40.0- 44.5	42.2
Length as a percentage of the length of digit III	65.3- 73.6	70.0	63.1- 73.3	66.5
Digit III				
Length in millimeters	56.0- 63.5	60.4	59.0- 69.0	63.4
Digit IV				
Length in millimeters	60.0- 69.0	65.3	76.5- 87.5	81.5
Length as a percentage of the length of digit III	99.3-112.3	107.9	120.6-138.0	128.5

¹ Digital length does not include length of unguis phalanx. Based on three males and three females of each species.

length was determined to the nearest half-millimeter. The length of digit III was taken as the standard for comparison of the lengths of the other digits. The articulated length of digit III was included in the total length of the leg elements.

Average lengths of the digits expressed as percentages of the length of digit III are given in Table 19. Greater absolute and relative length of digit IV is evident in the cormorant. The average absolute length of digit III is greater in the cormorant, yet this digit comprises a greater percentage of the total length of the leg elements in the Anhinga (Table 15). The length of digit IV is 26.7 per cent of the total length of the leg elements in the Anhinga and 27.8 per cent in the cormorant.

In the Anhinga, digit IV appears slightly shorter than digit III. Measurement of the skeletal elements of these digits (Table 19), however, shows that digit IV is longer than digit III. This is explained by the more proximal position of the trochlea for digit IV. (Also, lengths of unguis phalanges are not included in the lengths given for the digits, Table 19, and the unguis phalanx of digit IV is shorter than that of digit III.)

Intradigital values of phalanges are given in Table 20. The length of a phalanx was measured as the absolute length, not that between articulating surfaces. With the exception of phalanx 2 of digit IV in the Anhinga, the distal phalanges are shorter than the basal phalanx of the same digit in both species. It is evident, however, that the distal phalanges are comparatively longer in the Anhinga than they are in the cormorant.

Certain phalanges of the cormorant show greater width in relation to length than those of the Anhinga. This is particularly evident of phalanges 2 and 3 of digit IV.

Since chord measurements must be taken to express unguis length and since tips of these bones are easily broken or damaged in preparation, measurements of unguis length are not exact. However, they may be used for

TABLE 20
THE LENGTHS OF THE DISTAL PHALANGES OF THE ANHINGA AND THE CORMORANT EXPRESSED
AS PERCENTAGES OF THE LENGTH OF THE BASAL PHALANX¹

Measurement	Anhinga		Cormorant	
	Extremes	Mean	Extremes	Mean
Digit II, phalanx 2	83.0- 90.8	86.5	74.7-80.5	78.1
Digit III, phalanx 2	82.2-100.0	96.3	90.8-97.4	94.5
Digit III, phalanx 3	84.2- 96.4	90.3	75.0-80.8	78.1
Digit IV, phalanx 2	94.2-109.3	100.0	85.8-92.2	88.8
Digit IV, phalanx 3	77.2- 87.5	81.8	72.4-79.6	75.6
Digit IV, phalanx 4	77.2- 89.8	82.3	62.5-77.9	73.9

¹ Based on three males and three females of each species.

purposes of comparison (Table 21). The unguis phalanges of the Anhinga, excepting that of digit IV, are considerably longer than the corresponding ones of the cormorant. The nails exhibit a greater curvature in the Anhinga (Fig. 26). When the distance through the extensor and flexor processes at the bases of the unguis phalanges is expressed as a percentage of the length of the phalanx, the greater development of these processes in the Anhinga is evident (Table 21). This is indicative of greater ability to move the toes, a modification for arboreal habits.

In the Anhinga, the length of digit III comprises a greater percentage of the total length of the leg elements than it does in the cormorant. Miller (1937: 61-62) has pointed out that elongation of the toes (with reduction in webbing) may be regarded as an adaptation for climbing, and that elongation of the toes (with webbing) may be regarded as an adaptation for swimming. In this respect, the foot of the Anhinga has modification for perching (climbing too) and swimming. Although digit III is comparatively long and the webs connected to it are complete, which facilitates swimming, digit IV terminates proximal to the end of digit III. The latter is a characteristic of birds that perch. As digit IV is shorter than digit III in the Anhinga, there is comparatively less area of web between these digits in this species than in the cormorant; inspection of the foot (Fig. 26) shows that in the Anhinga the web between these digits is invariably considerably incised. Reduction in the area of the web between digits I and II in the Anhinga (Fig. 26) is conspicuous.

There are other modifications of the Anhinga's foot which may be correlated with this species' greater degree of arboreal habits. Fisher (1946: 655) called attention to the fact that it is characteristic of perching birds to exhibit a comparative reduction in length of basal phalanges and an elongation of the distal ones. Although the distal phalanges do not exceed the length of the basal ones, they are, nevertheless, longer in comparison with these in the Anhinga than in the cormorant (Table 20). Greater length of unguis phalanges, more pronounced curvature of the nails, greater development of extensor and flexor processes of the unguis phalanges are all modifications correlated with the Anhinga's more obvious perching and climbing habits. In the cormorant, flattening of certain phalanges and increase in the width of some of these correlates with this species' more aquatic habits.

TABLE 21
MEASUREMENTS AND PROPORTIONS OF THE UNGUAL PHALANGES OF THE
ANHINGA AND THE CORMORANT¹

Measurement or Proportion	Anhinga		Cormorant	
	Extremes	Mean	Extremes	Mean
Ungual phalanx, Digit I				
Length in millimeters	11.0-12.8	11.7	10.7-11.8	11.4
Height of proximal end in millimeters	5.0- 7.0	6.2	4.0- 4.6	4.3
Height of proximal end as a percentage of length of phalanx	42.7-59.8	53.0	35.0-40.3	37.7
Ungual phalanx, Digit II				
Length in millimeters	10.5-12.3	11.3	9.9-11.8	10.7
Height of proximal end in millimeters	4.2- 6.1	5.2	3.9- 4.5	4.1
Height of proximal end as a percentage of length of phalanx	37.1-54.0	46.0	36.5-42.1	38.3
Ungual phalanx, Digit III				
Length in millimeters	10.0-13.6	12.1	10.7-11.9	11.5
Height of proximal end in millimeters	4.1- 5.3	4.6	3.1- 4.0	3.6
Height of proximal end as a percentage of length of phalanx	33.8-43.8	38.0	28.9-34.7	31.3
Ungual phalanx, Digit IV				
Length in millimeters	9.1-11.5	9.8	9.4-11.1	10.3
Height of proximal end in millimeters	3.9- 4.4	4.1	2.6- 3.1	2.9
Height of proximal end as a percentage of length of phalanx	39.7-43.8	41.8	25.2-30.1	28.8

¹ Based on three males and three females of each species.

Myology of the Leg.—The terminology employed in discussing the muscles of the leg is that of Fisher (1946). Volumetric determinations were made as with the wing, the same four specimens (two males, two females) of each species being used.

M. EXTENSOR ILIO-TIBIALIS LATERALIS

General.—The thin anterior portion of the belly of this superficial muscle of the lateral surface of the thigh (Fig. 28) is continuous proximally with the belly of *M. extensor ilio-tibialis anterior*. The thick posterior portion of the belly lies along the posterior surface of *M. vastus lateralis*. The central portion of the muscle is variably aponeurotic.

Origin.—An aponeurosis from the anterior iliac crest extending from the origin of *M. extensor ilio-tibialis anterior*, with which it is continuous, posteriorly to and onto the iliac process and from the posterior surface of the antitrochanteric swelling (Fig. 39).

Insertion.—By stout fascia upon distal portions of lateral and posterior surfaces of *M. vastus lateralis* (Fig. 28).

Action.—Weak abduction of the thigh; with separate action of the anterior and posterior portions, the thigh would be drawn anteriorly or posteriorly. It must implement action of *M. vastus lateralis* under certain conditions.

Comparison.—In the Anhinga the central portion of the belly is considerably less aponeurotic: in three of four cormorants, the anterior and posterior portions of the belly had no fleshy connections whatsoever, while in all four Anhingas, the anterior and posterior portions all had fleshy connections.

The total volume of the muscle may constitute a somewhat greater proportion of the total leg musculature in the Anhinga (Table 22), although, from data of the limited number of specimens sampled, the difference was not found significant.

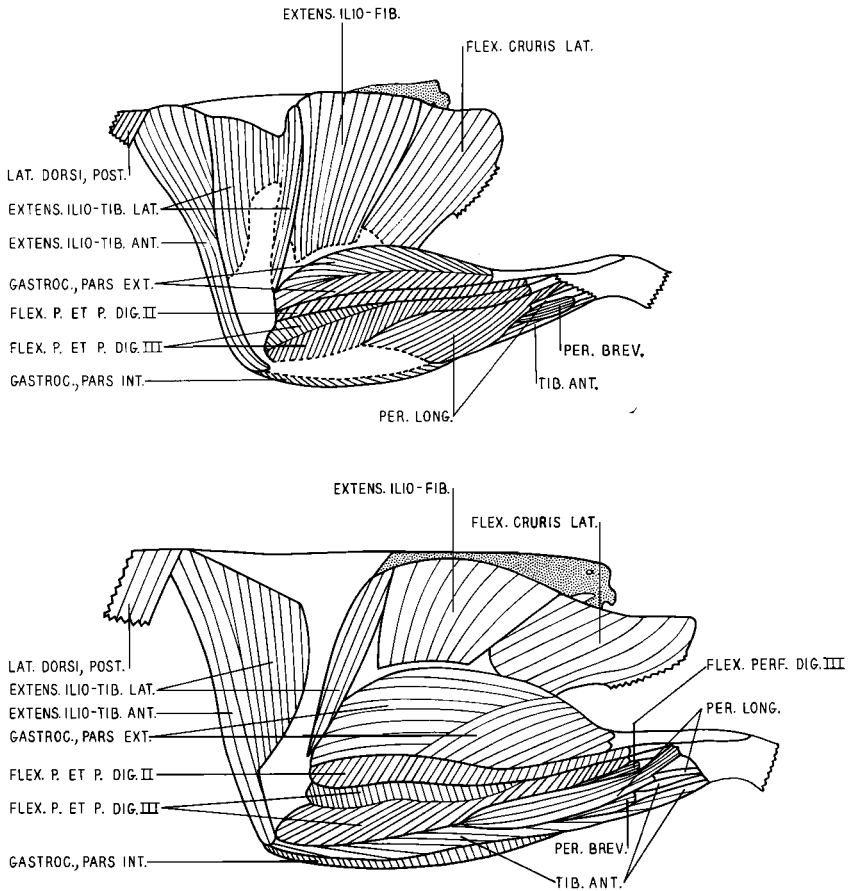

Figure 28. Lateral view of the superficial muscles of the thigh and shank of the Anhinga (*top*) and the cormorant.

Discussion.—Both this muscle and *M. vastus lateralis*, whose action it may supplement, are better developed in the Anhinga, the latter muscle being significantly larger in this species. Combined action of the two in effecting tibiotarsal extension is important mainly in non-swimming, pedal locomotion, since in swimming, tibiotarsal extension is relatively slight. Development of this muscle in the Anhinga, then, would seem to be correlated with a greater degree of non-aquatic pedal locomotion or, possibly, with a somewhat different type of limb action when submerged. Both of these factors may be important. It is interesting, however, that Miller (1937: 27) found the muscle comparatively bulkier in geese of more terrestrial habits.

If tibiotarsal extension is prevented by action of the flexors originating from the pelvis, contraction of this muscle then effects tibiotarsal abduction. In the cormorant this must be a more important function of the muscle than in the Anhinga since the posterior portion of the belly is comparatively bulkier than in the Anhinga. This portion of the belly lies along, and inserts upon, that portion of *M. vastus lateralis* which inserts upon the cnemial crest and not upon the patella; in this case abduction of the tibiotarsus would appear of greater effectiveness. Flexors which make this action of *M. extensor ilio-tibialis lateralis* possible are better developed in the cormorant.

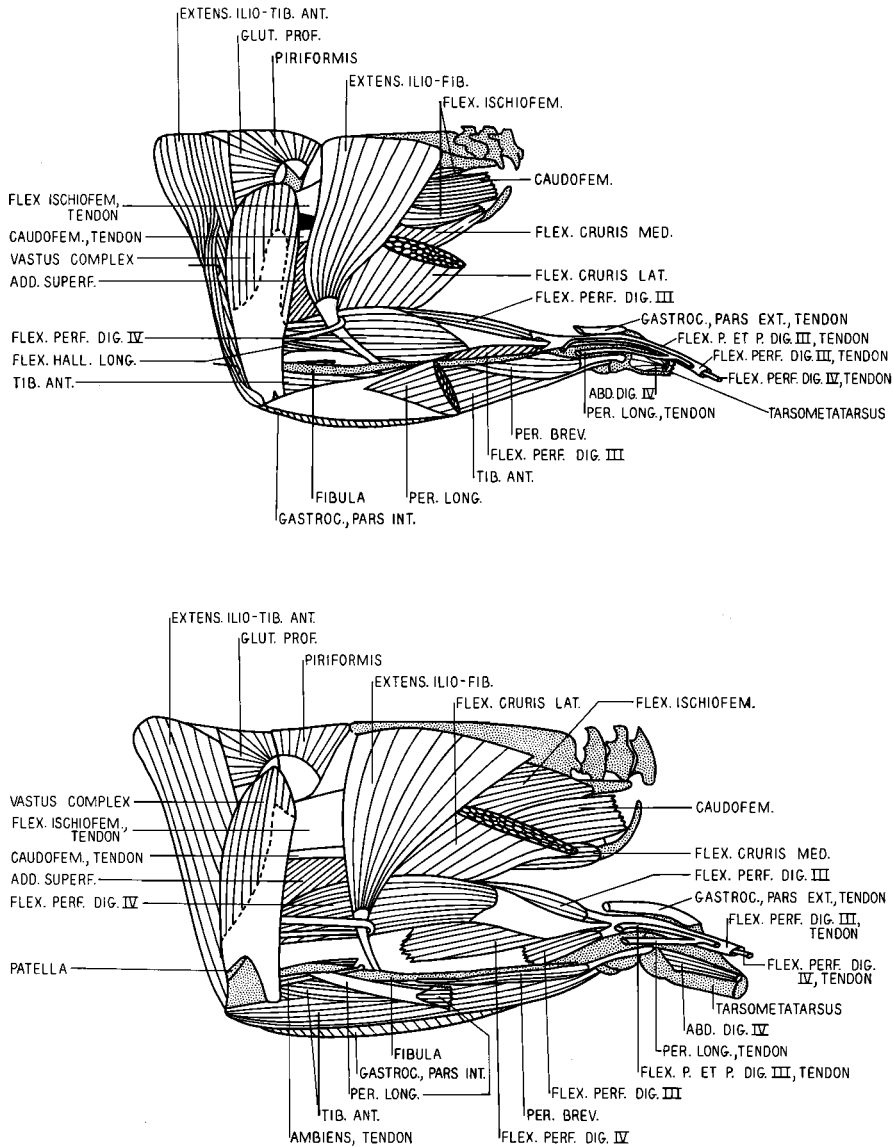

Figure 29. Lateral view of a second layer of muscles of the thigh and shank of the Anhinga (*top*) and the cormorant.

M. EXTENSOR ILIO-TIBIALIS ANTERIOR

General.—This large muscle covers the anterior, anterolateral, and anteromesial surfaces of the thigh (Figs. 28, 29, 33). *M. latissimus dorsi pars posterior* lies superficial to and makes variably weak fleshy connection with the proximal few millimeters of the anterior portion of that belly. The anterior portion of *M. gluteus profundus* lies deep to the proximal portion of the belly. Bellies of the vastus complex lie deep to the distal portion

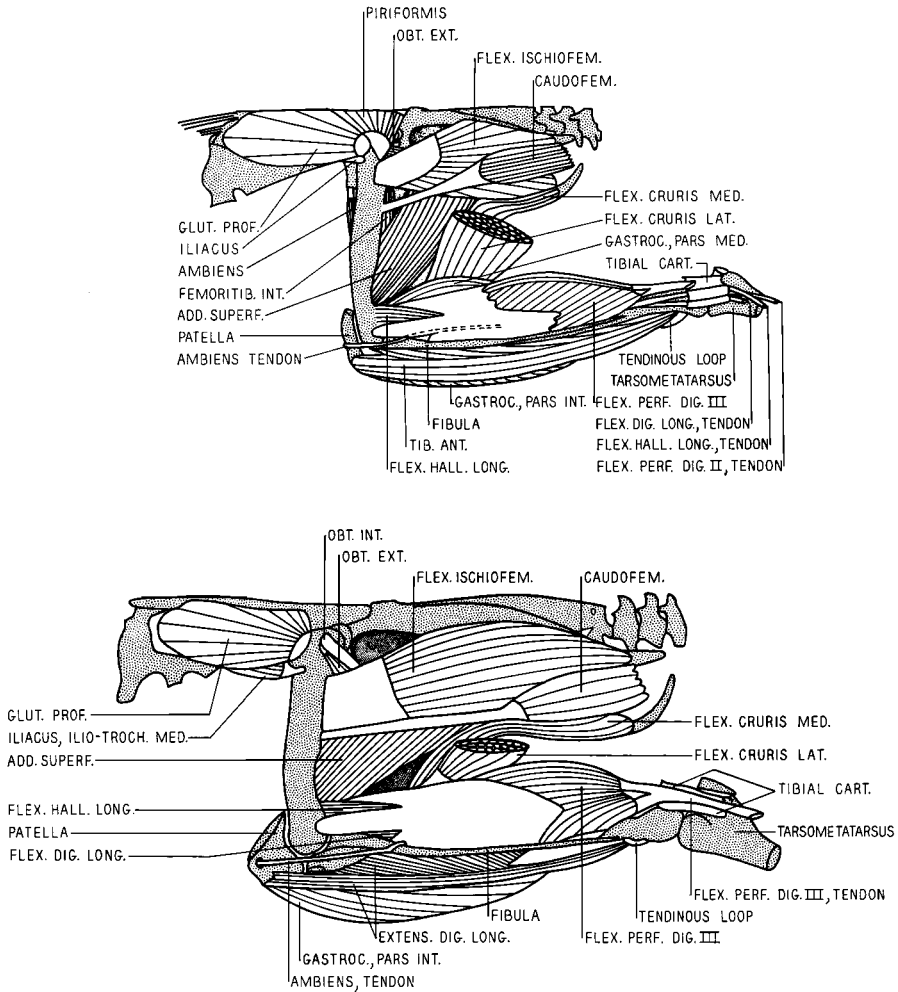

Figure 30. Lateral view of a third layer of muscles of the thigh and shank of the Anhinga (*top*) and the cormorant.

of the muscle. The proximal portion of the posterolateral border of the belly is continuous with that of *M. extensor ilio-tibialis lateralis*.

Origin.—Largely fleshy from the anterior end of the anterior iliac crest (Fig. 39).

Insertion.—Largely fleshy upon the whole of the dorsal half of the anterior surface of the patella (Fig. 43). Variable fleshy connections are made to *Mm. tibialis anterior*, *gastrocnemius pars interna*, and *flexor perforans et perforatus digiti III*.

Action.—Flexes the femur; extends the tibiotarsus.

Comparison.—In the Anhinga, the insertion covers the anterior face of the patella, whereas in the cormorant the insertion is upon the dorsal half of the mesial surface, the narrow anterior edge, and a narrow area upon the anterolateral surface of the patella.

The lateral portion of the belly is more extensive in the Anhinga, in which it covers a greater portion of the lateral surface of *M. vastus lateralis*.

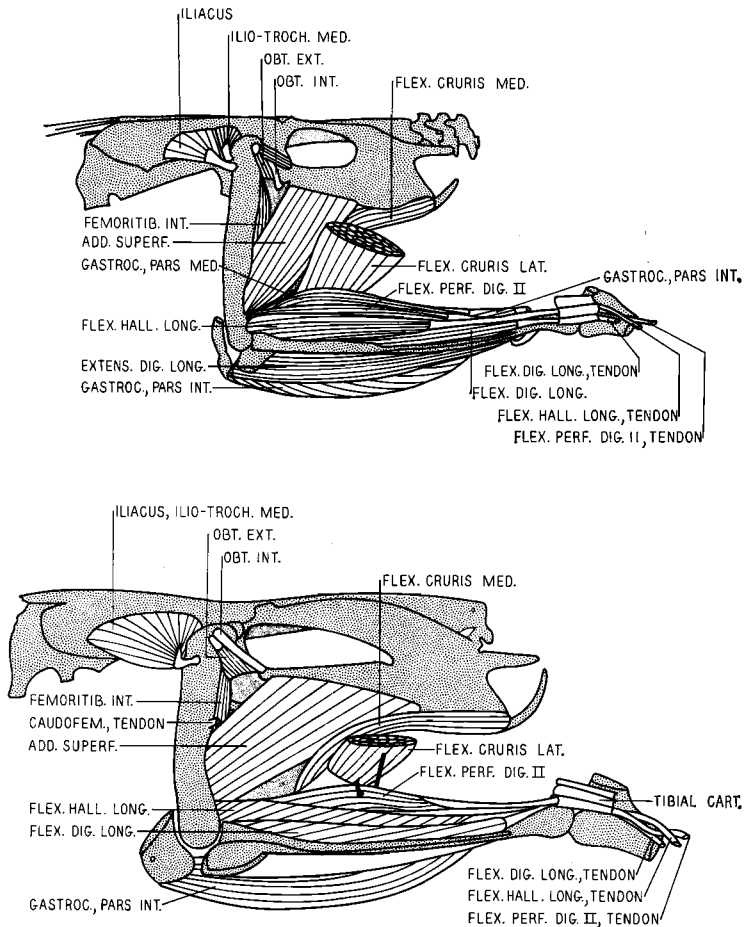

Figure 31. Lateral view of a fourth layer of muscles of the thigh and shank of the Anhinga (*top*) and the cormorant.

The total volume of the muscle constitutes a significantly greater percentage of the total leg musculature in the Anhinga (Table 22).

Discussion.—Miller (1937: 26) cited the importance of this muscle in flexing the femur in the recovery stroke in terrestrial locomotion and in extending the tibiotarsus, actions which are particularly important in jumping and climbing. Such actions are slight during swimming. The comparatively greater bulk of this muscle in the Anhinga, then, can be correlated with the greater degree of arboreal progression in this species. In the cormorant, the muscle is probably of importance not only in its more limited non-aquatic progression but also during jumping incident to taking off from the water.

The comparative development of the patellas and the insertions of this muscle upon it indicate that the muscle's function as a flexor of the femur may be more effective in the Anhinga. The femur constitutes a somewhat greater proportion of the leg length in the Anhinga than it does in the cormorant, and motion of the femur is apparently considerably less restricted in non-aquatic pedal locomotion.

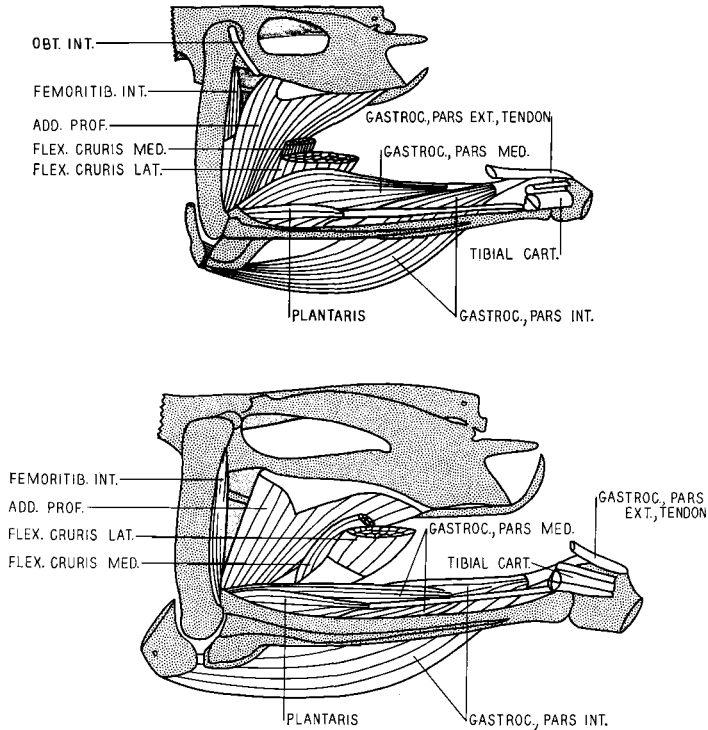

Figure 32. Lateral view of a fifth layer of muscles of the thigh and shank of the Anhinga (top) and the cormorant.

M. PIRIFORMIS

General.—This is a small, flat muscle passing from the pelvis to the femoral trochanter (Fig. 29). Its anterior border lies superficial to *M. gluteus profundus*.

Origin.—Fleshy from the anterior surface of the iliac process; the anterior iliac crest at the level of, and cranial to, the latter; the anterodorsal surface of the antitrochanter; and the dorsal surface of the ilium cranial to the antitrochanter (Fig. 39).

Insertion.—The thin, triangular tendon forms proximal to the femur, crosses the trochanter, and passes to insert upon the lateral surface of the proximal head of the femur (Fig. 40).

Action.—Abduction of the femur; along with other muscles, it is important primarily in the statics of the femur.

Comparison.—The insertion is not as far distal on the femoral head in the Anhinga as it is in the cormorant.

Discussion.—The more distal insertion in the cormorant indicates a slower but more powerful muscular action in this species. A more rapid, less powerful action is indicated in the Anhinga.

M. GLUTEUS PROFUNDUS

General.—The anterior and posterior portions of this muscle lie deep to *M. extensor ilio-tibialis anterior* and the aponeurosis of origin of *M. extensor ilio-tibialis lateralis*, respectively (Figs. 29, 30). The caudal border of the belly lies deep to *M. piriformis*. The distal portion of the belly is superficial to *Mm. iliacus* and *ilio-trochantericus medius*.

Origin.—Fleshy from the length of the anterior iliac crest cranial to the origin of *M. piriformis* and from the greater portion of the preacetabular ilium (Fig. 39).

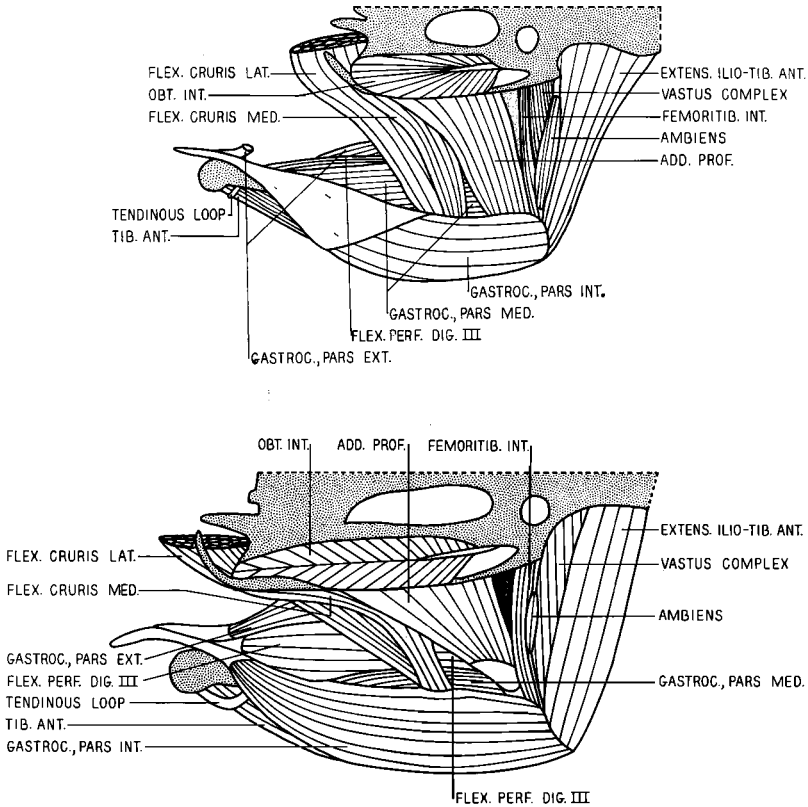

Figure 33. The superficial layer of muscles of the mesial surface of the thigh and shank of the Anhinga (*top*) and the cormorant.

Insertion.—Tendinous upon the anterior portion of the lateral surface of the femoral trochanter (Fig. 40).

Action.—Rotates the femur anteriorly; important in the statics of the femur.

Comparison.—This tends to be a smaller muscle in the Anhinga (Table 22).

Discussion.—Miller (1937: 23) found the bulk of this muscle less in geese of more terrestrial habits than in those of more aquatic tendencies. He attributed this to a relative decrease in size made apparent by the greater development of the other leg muscles. The ability to rotate the femur and thereby change the position of the foot may be important during standing in birds with little flexibility of the toes and no reduction in foot webbing. I have observed a line of 14 cormorants standing on a bulkhead. Each bird had moved its right foot to a position nearly under the center of the body and rotated the foot until the large web was apparently best placed to support the weight of the bird. (The other foot was then partially retracted into the plumage or placed loosely upon the first.) The Anhinga when standing is able to effect greater individual positioning of the toes both as a result of the reduced webbing and the greater development of the short toe flexors.

M. ILIACUS AND M. ILIO-TROCHANTERICUS MEDIUS

General.—The bellies of these muscles are to a large extent inseparable (Figs. 30, 31); *M. gluteus profundus* lies superficial to them.

Origin.—Fleshy from a semicircular area of the dorsolateral surface of the proximal half of the preacetabular ilium (Fig. 39).

Insertion.—In three of four specimens examined of each species a common tendinous insertion was made upon the femoral trochanter immediately distal to the insertion of *M. gluteus profundus* (Fig. 40). Where separate insertions were made (Fig. 40) these were contiguous, that of *M. iliacus* being the more distal. Fleshy fibers passing to the mesial surface of the trochanter were also noted.

Action.—Similar to that of *M. gluteus profundus*.

Comparison.—Bellies of the muscles are more distinct in the Anhinga.

Discussion.—See the discussion of *M. gluteus profundus*.

M. VASTUS LATERALIS AND M. VASTUS MEDIALIS

General.—The line of fusion of these two muscles is represented by a raphe lying between the proximal portions of their bellies. This parallels the anterior intermuscular line of the femur. Because the muscles are inseparably fused they will be considered as a single unit (Figs. 29, 33) and are referred to as the vastus complex. The combined belly covers the anterior and large portions of the lateral and mesial surfaces of the femoral shaft. Anterior, anterolateral, and anteromesial portions of the muscle lie deep to *M. extensor ilio-tibialis anterior*. *M. extensor ilio-tibialis lateralis* lies superficial to the proximal portion of the lateral surface and posterior margin of the lateral surface of the muscle and inserts upon the muscle itself.

Origin.—Fleshy from the anterior surface and from large portions of the lateral and mesial surfaces of the femoral shaft (Fig. 40).

Insertion.—Fleshy upon the dorsal surface of the patella and tendinous upon the edge surrounding the dorsal surface of the patella (Fig. 43); tendinous upon the lateral surface of the outer cnemial crest (Fig. 41).

Action.—Extension of the tibiotarsus.

Comparison.—This muscle constitutes a significantly greater percentage of the volume of the total leg musculature in the Anhinga (Table 22).

The area of insertion is comparatively larger in the cormorant, in which the patella, especially its dorsal surface, is considerably larger.

Discussion.—Miller (1937: 31) found this muscle comparatively large in *Nesochen* and correlated its development with its "great use in jumping, climbing, and to a noticeable degree in running." The relatively greater volume of the muscle in the Anhinga would seem to be correlated with its terrestrial or arboreal habits. Since the muscle has little function in swimming, its large size in the cormorant may be correlated to some extent, at least, with the latter's jumping take-offs from water. (It should be noted that in a bird moving with wings outstretched and flapping, lift is a functional force and the entire weight of the body is by no means supported by the feet alone.) Thus the greater degree of development of the muscle in the Anhinga, which supports the weight of its body on its feet while walking, jumping, and scrambling through and along the branches, is understandable in comparison with a bird which seemingly has a major need of such muscular development for running take-offs and limited perching and terrestrial progression.

M. EXTENSOR ILIO-FIBULARIS

General.—The proximal portion of this large muscle is in superficial view (Figs. 28, 29). Deep to its proximal portion lies *M. flexor ischiofemoralis*. The belly narrows distally and penetrates the shank musculature between *Mm. gastrocnemius, pars externa* and *flexor perforatus digiti IV*. The direction of force exerted by the muscle is controlled by a tendinous loop through which the tendon of insertion passes. This loop is closely applied to the mesial surface of *M. gastrocnemius, pars externa*, and its ends attach to the femoral shaft (Fig. 40).

Origin.—Fleshy from the posterolateral surface of the iliac process and the lateral surface of the iliac crest to the base of the ilio-caudal style (Fig. 39). The origin may extend onto the posterior surfaces of the antitrochanter.

Insertion.—By a stout tendon upon a prominence of the dorsal surface of the fibula (Fig. 41). The tendon forms just proximal to, or within the tendinous loop which encloses it.

Action.—Flexion of the tibiotarsus. With opposition by tibiotarsal extensors, femoral extension is accomplished. During swimming the muscle probably functions chiefly to hold the tibiotarsus in place.

Comparison.—This muscle tends to comprise a greater percentage of the total leg musculature in the Anhinga (Table 22). In the Anhinga the origin of the muscle is from the

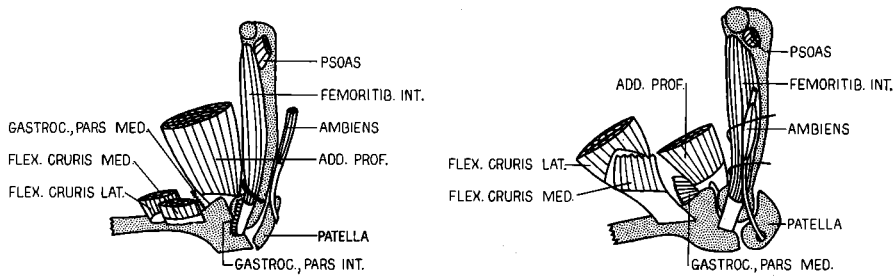

Figure 34. Some muscles of a second layer of the mesial surface of the thigh and shank of the Anhinga (left) and the cormorant.

lateral surface of the posterior iliac crest; in the cormorant the origin is from a wide area of the bordering ilium itself. It should be noted that the elevation of the posterior iliac crest of the cormorant is comparatively weak.

Discussion.—Miller (1937: 62) considered that great bulk of this muscle was a feature associated with swimming power. Yet he found it comparatively well developed in *Nesochen* and was unable to explain its relatively weak development in *Chen*, an efficient swimmer. The situation is similar in the two species under investigation herein, in which the muscle tends to be larger in the Anhinga. Fisher (1946: 698) pointed out that *M. extensor ilio-fibularis* as well as other tibiotarsal flexors originating from the postacetabular pelvis "are so significant in so many actions . . . that correlations with differences in single action is impossible." Fisher called attention to a function of this muscle which may be important in consideration of the Anhinga and in other birds modified for aquatic progression. Such birds, with their feet placed well posteriorly along their body axis, tend to be overbalanced anteriorly when standing and perching. The tibiotarsal flexors originating from the postacetabular pelvis flex the femur posteriorly and thus help to hold the anterior part of the body upright. This may help to explain the somewhat larger size of the muscle in the Anhinga and in *Nesochen*. The relative positions of insertion upon the fibula are similar in the Anhinga and the cormorant.

M. FLEXOR CRURIS LATERALIS

General.—The proximal portion of this large muscle, which forms the posterior border of the thigh, is in superficial view (Figs. 28–34). *M. extensor ilio-fibularis* lies anterior to it, and *Mm. flexor ischio-femoralis*, *flexor cruris medialis*, and *caudofemoralis* lie deep to its proximal portion. Along the proximal portion of its posterior border, the muscle is invested with heavy fascia, which attaches to the skin and musculature of the caudal region. The belly, with that of *M. flexor cruris medialis*, penetrates the shank musculature between the bellies of *Mm. gastrocnemius, pars interna*, and *gastrocnemius, pars media*.

Origin.—Fleshy from the lateral surface of the ilio-caudal spine and from the distal portion of the transverse process of free caudal vertebra II (Fig. 39). It may also arise from a small area at the distal end of the transverse process of free caudal vertebra I, the transverse processes of which abut the ilio-caudal spine. The origin from free caudal vertebra II is contiguous with that of *M. lateralis caudae*.

Insertion.—The belly narrows and flattens after penetrating the shank musculature. A narrow, elongated insertion is made upon the mesial surface of the anterior end of the tibial shaft; the insertion is parallel to, but separate from, that of *M. flexor cruris medialis* (Fig. 41).

Action.—The most pronounced action is flexion of the tibiotarsus. In addition, it draws the latter as well as the femur posteriorly, and it rotates the tibiotarsus in such fashion that the mesial surface is moved upward and outward.

Comparison.—In the cormorant, the muscle takes origin from the transverse processes of free caudal vertebrae III and IV instead of from free caudal vertebra II as in the Anhinga.

In the cormorant this muscle makes a common insertion with *M. flexor cruris medialis*.

Discussion.—This is the largest muscle in the Anhinga leg (Table 22); in the cormo-

rant the muscle is exceeded in volume by only that of *M. gastrocnemius, pars externa*. As with *M. extensor ilio-fibularis*, large size of this muscle is usually correlated with aquatic modification. The comparatively large size of this muscle in the Anhinga is therefore difficult to correlate with habits unless it is important in raising the anterior end of the body while the bird is in a standing position.

As with *M. extensor ilio-fibularis*, the more posterior origins of the muscle from the relatively elongated postacetabular elements in the cormorant must result in greater power of contraction but reduced speed of such.

Fleshy origin from the caudal vertebrae is of interest. Fisher (1946: 664) was emphatic in commenting upon the lack of caudal origin of this muscle in the New World vultures in contrast to the findings of vertebral origins by Hudson (1937: 22).

The possible significance of the common insertion of this muscle with that of *M. flexor cruris medialis* is discussed under that muscle.

M. FLEXOR CRURIS MEDIALIS

General.—This flat, small muscle is superficial, in part, upon the mesial surface of the thigh (Figs. 29–34). The posterior three-fourths of the belly lies deep to the inner surface of *M. flexor cruris lateralis*.

Origin.—Fleshy from the edge of the expanded distal portion of the ischium extending variably but narrowly onto the adjacent lateral surface of the ischium; fleshy, but variable, from the expanded lateral surface of the pubis adjacent to the ischial origin (Fig. 39).

Insertion.—The flattened distal portion of the belly penetrates the shank musculature closely applied to the deep surface of *M. flexor cruris lateralis*. The short tendon forms just proximal to insertion upon the mesial surface of the proximal end of the tibial shaft; the insertion is (with the tibia in swimming position) ventral to, and in part cranial to, the insertion of *M. flexor cruris lateralis* (Figs. 34, 41).

Action.—Similar to that of *M. flexor cruris lateralis*. Its more ventral position, however, restricts its effectiveness to situations in which the tibiotarsus is not extremely flexed.

Comparison.—The volume of the muscle constitutes a similar percentage of the total leg musculature in both species (Table 22).

In the cormorant, this muscle has a common insertion with that of *M. flexor cruris lateralis*; the insertions of these muscles are separate in the Anhinga.

Discussion.—As with the two preceding muscles, the unexpectedly small volume of this muscle in the cormorant is difficult to correlate with its greater degree of aquatic modification.

Again as with the two preceding muscles, the comparatively more posterior origins of the muscle probably result in greater power of contraction but less speed of contraction in the cormorant.

The independent insertion of this muscle in the Anhinga may be a modification allowing more delicate control of the tibiotarsus. This would be concomitant with the greater degree of tibiotarsal extension accompanying pedal progression out of the water. During swimming, there is little extension of the tibiotarsus, and the chief function of this muscle and the two preceding ones appears to be opposing the force of the swimming stroke that would tend to extend the tibiotarsus.

M. CAUDOFEMORALIS

General.—This a long, flat, narrow muscle extending from the caudal musculature to the femur (Figs. 22, 23, 29, 30). Its belly emerges from the caudal musculature between *Mm. depressor coccygis* and *lateralis coccygis* and enters the thigh musculature deep to *M. flexor cruris lateralis* and superficial to *M. flexor ischiofemoralis*. The tendon of insertion forms midway along the length of the belly of the latter. In one of four Anhingas examined, a well-defined fleshy connection, which originated from the mid-portion of the posterior iliac crest, was made to the center of the belly. The latter apparently represents the "accessory" or "iliac head" of *M. caudofemoralis*. Garrod (1876a: 340) did not find this in his dissection of *Anhinga anhinga* and stated that it was absent in all other true members of the order.

Origin.—According to Fisher (1946: 665) patterns of development indicate that the caudal connections and not the femoral ones are to be regarded as the origin of the muscle. Accordingly, origin is from the aponeurosis covering the ventral surface of *M. lateralis coccygis* (Figs. 22, 23). It has no connections to the pygostyle.

Insertion.—By a long, narrow tendon upon the posterior surface of the femoral shaft (Fig. 40).

Action.—Possible functions of this muscle have invited considerable speculation (Miller, 1937: 25–26). Contraction of the belly of but one side would draw the tail laterally. Simultaneous contraction upon both sides would serve to depress the tail. It is possible that during landings, when the legs are outstretched, the femora serve as functional origins, and tail depression, which furnishes braking force, results. Fisher (1957: 484) found experimentally in pigeons that the muscles contribute to depression of the tail and, possibly, to abduction of the rectrices. The former action is apparently important in braking water landings in the cormorant. Miller (1937: 26) suggested that a possible function may be that of bracing the femur during swimming. The iliac head would function as an extensor of the femur.

Comparison.—The muscle volume is similar in the two species (Table 22).

In the cormorant, the belly may be directly superficial to the ischium along its distal portion; and its belly and tendon then tend to parallel those of *M. flexor ischiofemoralis*. In the Anhinga, the belly crosses that of the latter muscle obliquely and at no point lies directly superficial to the ischium.

In the cormorant, the femoral insertion is contiguous with that of *M. flexor ischiofemoralis*; in the Anhinga, the insertion is distal to that of the latter muscle.

Discussion.—Miller (1937: 26) found no correlation of development of this muscle with aquatic adaptation. However, the insertion of the muscle is of interest. In the loon, *Gavia immer*, which is likewise more strongly modified for underwater progression than is *Anhinga*, Wilcox (1952: 523) found the tendon of insertion of *M. caudofemoralis* fused with that of *M. flexor ischiofemoralis*, not merely contiguous with it as in the cormorant. The degree of intimacy of these tendons may be an indication of adaptation for aquatic progression.

The presence of an iliac head in one specimen of the Anhinga necessitates a qualification in Garrod's (1874) muscle formula for this species. Variation of this muscle would seem to invalidate, to some extent, the significance of its use in that formula.

M. FLEXOR ISCHIOFEMORALIS

General.—This is a well-developed muscle of the deep layer immediately superficial to the postacetabular pelvis (Figs. 29, 30).

Origin.—Fleshy from the greater portion of the ischium and from the postacetabular ilium ventral to the posterior iliac crest (Fig. 39). The origin may extend onto the proximal portion of the ilio-caudal spine.

Insertion.—By a wide tendon to the lateral half of the posterior surface of the proximal portion of the femoral shaft (Fig. 40).

Action.—Draws the femur backward and rotates it to produce a toe-out position of the foot. Along with other muscles, it is important in the statics of the femur.

Comparison.—In the specimens measured, the volume of the muscle was of possibly significantly greater volume in the cormorant (Table 22).

The longest axis through the insertion is longer in the cormorant, averaging approximately thirteen millimeters in that species and six millimeters in the Anhinga.

There is no origin from the ischial process in the cormorant as there is in the Anhinga. The extension of the origin onto the proximal surface of the ilio-caudal spine is variable in the Anhinga but apparently constant in the cormorant.

Discussion.—An important function of this muscle may be in opposing the force of the swimming power-stroke, which tends to push the femur forward. In rotating the foot it may be of importance not only in balancing the distribution of force upon the web during swimming, but also in moving the foot-web into more appropriate standing position.

M. ADDUCTOR SUPERFICIALIS

General.—This stout muscle lies superficial to *M. adductor profundus* (Figs. 29–31); the distal portion of its anterior margin is closely connected to the aponeurosis of insertion of *M. adductor profundus*.

Origin.—Mixed, from a narrow area of the lateral surface bordering the ventral edge of the ischium, extending from the level of the obturator foramen to the distal end of the ischio-pubic fenestra (Fig. 39). This is variable, however, and the origin may extend only onto the ventral edge of the ischium or it may be restricted to the membrane of the ischio-pubic fenestra.

Insertion.—Fleshy upon the posterior surface of the femoral shaft (Fig. 40). The distal portion of the insertion occupies more than half the width of the femoral shaft; the insertion tapers to a point at its proximal end.

Action.—Extension of the femur and rotation of it to produce a toe-out position.

Comparison.—This is a significantly larger muscle in the Anhinga (Table 22).

The muscle occupies a more cranial position in the Anhinga and therefore makes a smaller angle with the axis of the femur. The origin extends farther into the popliteal area in the Anhinga.

Discussion.—A variety of functions is possible for this muscle. Miller (1937: 24) believed that a large portion of its force acts to thrust the femur dorsally against the acetabulum. This force is important in posture, particularly when the femur is slightly extended. Because in the Anhinga the muscle is more dorsally placed in relation to the femur, this action would seem to be of importance. Likewise, the action of the muscle in effecting femoral extension in the Anhinga would seem to be of relatively less importance. When the bird is standing, contraction of this muscle would depress the pelvis and elevate the anterior end of the body.

The relatively more caudal position of the muscle in the cormorant with resultant force upon the femoral shaft more nearly perpendicular to the latter would indicate importance of the muscle in extension of the femur, or in opposition of the force upon the femur during swimming.

The relative positions of the muscle with respect to the femur would seem to be correlated with different modes of progression in the two species.

M. ADDUCTOR PROFUNDUS

General.—This is a wide, flat muscle of the mesial surface of the thigh (Figs. 32–34). The distal portion of the belly is attached along its cranial border to connective tissues, which pass to the posterior surface of the femur and to the bellies of *M. ambiens*, the vastus complex and to other muscles of the inner surface of the thigh. The cranial margin of the extreme distal portion of the belly lies superficial to the distal end of *M. femorotibialis internus*.

Origin.—The anterior two-thirds or so arise from the membrane covering the ischio-pubic fenestra; the remainder is fleshy from the ventral edge of the ischium (Fig. 39). The anterior end of the origin may also be from the ischium, and a variable amount of the posterior end of the origin may also come from the ischium.

Insertion.—Fleshy upon the dorsal surface of the internal femoral condyle and tendinous upon the dorso-mesial surface of the inner articulating prominence of the tibia (Figs. 34, 40, 41). The mesial surface of the insertion is variably attached to the lateral surface of the head of origin of *M. gastrocnemius, pars media*.

Action.—Similar to that of *M. adductor superficialis*. Insertion upon the tibial head may augment the action of the muscle in drawing the leg upward. Contraction of the posterior portion of the belly flexes the tibiotarsus.

Comparison.—The relative volume is significantly greater in the Anhinga (Table 22). As with the preceding muscle, the area of origin is more anterior in the Anhinga. An entirely tendinous insertion was found in the cormorants examined; the femoral portion of the insertion is fleshy in the Anhinga.

Discussion.—In both species the insertions of this muscle are more ventral and more posterior than those of *M. adductor superficialis*. In the Anhinga, this would make the effects described for *M. adductor superficialis* even more pronounced. The more caudal origins indicate comparatively greater efficiency in drawing the leg posteriorly and in opposing femoral flexion in the cormorant.

M. AMBIENS

General.—This is a short, slender muscle of the mesial surface of the thigh (Fig. 33).

Origin.—By a long tendon from the pectineal process (Figs. 33, 39).

Insertion.—The tendon passes deep to *M. extensor tibialis anterior* and crosses the anterior surface of the patella within an obliquely inclined groove. On the lateral surface of the shank the tendon emerges from a position deep to the patellar tendon, crosses the lateral surface of the tibial and fibular heads, and passes deep to the aponeurosis of origin, to which *Mm. flexor perforatus digiti IV, flexor perforatus digiti III, flexor perforans et perforatus digiti III, flexor perforans et perforatus digiti II* and other flexor muscles attach (Figs. 29, 30). Two-thirds of the way along the shank the tendon becomes indistinguishably fused to the latter aponeurosis.

Action.—Augmentation of the force exerted by the toe flexors found upon the shank; adduction and extension of the thigh; weak extension of the tibiotarsus.

Comparison.—The belly of the muscle is longer and of significantly greater volume in the Anhinga (Table 22).

The point of origin of the muscle, the pectineal process, lies cranial to the acetabulum in the Anhinga; in the cormorant the pectineal process lies ventral to the acetabulum.

Discussion.—Miller (1937: 27) found no correlation of the development of the muscle with habit and cautioned that the many possibilities of its action make it difficult to correlate differences in development with function.

The more anterior position of the origin of the muscle in the Anhinga would indicate a more important function of drawing the knee cranially in this species. It might also indicate that the muscle would be most effective in its action on the tibiotarsus and the toe flexors lying along the latter when the femur is slightly flexed.

M. FEMORITIBIALIS INTERNUS

General.—The muscle originates from, and lies along, the postero-mesial surfaces of the femur (Figs. 32–34).

Origin.—Fleshy from portions of the mesial and posterior surfaces of the femur (Fig. 40).

Insertion.—The stout tendon crosses the patellar tendon and inserts upon a prominence at the anterior end of the mesial surface of the inner cnemial crest of the tibia (Fig. 41). *M. gastrocnemius, pars interna* may make fleshy or tendinous connections to this tendon (Fig. 34).

Action.—Extension of the tibiotarsus and rotation of the tibia upward and inward. The force exerted by the muscle must be weak.

Discussion.—Miller (1937: 32) found only slight variations in the bulk of the muscle among geese and he did not believe that the muscle showed adaptive modifications in these birds.

M. PSOAS

General.—Delimitation of this very small, short bellied, and somewhat variable muscle (Fig. 34) is difficult inasmuch as it is closely connected to, and invested with, connective and vascular tissue.

Origin.—Fleshy from the lateral surface of the ilium dorsal and anterior to the pectineal process and ventral to the origin of *M. ilio-trochantericus medius* (Fig. 39).

Insertion.—Fleshy upon the mesial surface of the femoral shaft ventral to the femoral head (Fig. 40).

Action.—Weak adduction and rotation of the femur.

M. OBTURATOR EXTERNUS

General.—The tendon of *M. obturator internus* separates the lateral surface of the belly of this muscle into dorsal and ventral portions (Fig. 31).

Origin.—Fleshy from the lateral surface of the ischium dorsal to the obturator foramen (Fig. 39). The origin extends dorsally to the ventral portion of the antitrochanter and ventrally onto the membrane covering the obturator foramen. In one specimen fleshy fibers arose from the dorsal portion of the pubis.

Insertion.—Superficial fibers of the divided belly converge proximal to the insertion of the tendon of *M. obturator internus*. There is formed a thin, wide tendon which passes superficial to the insertion of the latter muscle and inserts anterior to it upon the lateral surface of the antitrochanter. Deep portions of the belly insert posterior to, and upon the tendon of insertion of, *M. obturator internus* (Fig. 40).

Action.—Rotation of the femur so that its anterior surface moves laterally and posteriorly. It draws the femoral head posteroventrally into the acetabulum.

Comparison.—Variation in the volume of this muscle in the cormorant makes comparison of it uncertain (Table 22).

In the cormorant, the tendon of *M. obturator internus* passes superficial to the belly of this muscle but does not divide it into dorsal and ventral portions, and the tendinous insertion lies ventral to that of *M. obturator internus* rather than anterior to it as in the Anhinga. The area of fleshy insertion is relatively greater in the cormorant.

M. OBTURATOR INTERNUS

General.—This is a relatively stout bipennate muscle of the mesial surface of the pelvis (Fig. 33).

Origin.—Fleshy from the mesial surface of the ischium caudal to the obturator foramen and ventral to, and from the conspicuous ridge of, the dorsal portion of the inner surface of the ischium (Fig. 33).

Insertion.—The stout tendon passes through the obturator foramen and divides the

belly of *M. obturator externus* and then passes to attachment upon the lateral surface of the trochanter (Figs. 31, 32).

Action.—Similar to that of *M. obturator externus*.

Comparison.—It originates from a considerably larger area of the longer ischium of the cormorant.

Discussion.—The larger area of insertion, which extends farther posteriorly in the cormorant, must result in considerably more force being exerted by the muscle in this species. The force of this muscle is antagonistic, in considerable part at least, to that of *Mm. gluteus profundus, iliacus, ilio-trochantericus medius, and piriformis*. Its action is to pull the head of the femur laterally and ventrally and thus move the knee inward. The muscles cited above comprise a greater proportion of the total volume of the leg in the cormorant than they do in the Anhinga (Table 22). Their possible adaptive significance is discussed under *M. gluteus profundus* (page 78).

M. GASTROCNEMIUS, PARS INTERNA

General.—This large muscle occupies the ventral portion of the inner surface of the shank (Figs. 28–33). *M. gastrocnemius, pars media* lies dorsal to and fuses with it.

Origin.—Fleshy from the ventromesial quarter of the anterior surface of the patella and from the mesial surface of the inner cnemial crest (Figs. 41, 43). Variable origin may also be taken from the inserting tendon of *M. femorotibialis internus* (Fig. 34) and from the ventromesial surface of the tibial shaft adjacent to the cnemial crest.

Insertion.—The stout tendon forms along the distal fourth of the shank and fuses with the mesial surface of the tendon of *M. gastrocnemius, pars externa*. A common insertion is made upon the hypotarsus.

Action.—Since its origins are largely from the tibia, this muscle does not flex the shank; its action then is extension of the tarsometatarsus.

Comparison and Discussion.—See *M. gastrocnemius, pars externa*.

M. GASTROCNEMIUS, PARS EXTERNA

General.—This is a large bipennate muscle of the dorsal half of the lateral surface of the shank (Fig. 28). The tendinous loop which surrounds the tendon of insertion of *M. extensor ilio-fibularis* is closely applied to the deep surface of the belly.

Origin.—Mixed, from the posterior surface of the distal end of the femoral shaft (Fig. 40).

Insertion.—By a wide calcified tendon upon the hypotarsus (Fig. 32). Proximal to insertion the tendon is joined by that of *M. gastrocnemius, pars interna*.

Action.—Extension of the tarsometatarsus. Since its origin is from the femur, tibial flexion can also be effected.

Comparison.—The combined volume of the external and internal heads is equal to 20 per cent of the volume of the leg muscles in the cormorant and 14 per cent in the Anhinga. In the latter, the internal head is larger than the external head; in the cormorant, this difference is reversed. In the Anhinga, the external head occupies the lateral half of the dorsal surface of the shank; in the cormorant, this belly occupies the entire dorsal surface of the shank.

Muscle fibers are arranged in bipennate pattern in the Anhinga. In the cormorant, the arrangement is somewhat different (Fig. 28).

Discussion.—The external head, in causing extension of the tarsometatarsus and flexion of the tibiotarsus, effects the propulsion movement in swimming. This head is, relative to the total volume of the leg musculature, almost twice as large in the cormorant as in the Anhinga (Table 22). The internal head, originating from the tibiotarsus, cannot flex this portion of the leg except through *pars media*, and is, according to Miller (1937: 34), most efficient in running. The relative volumes of the internal heads are similar in the two species (Table 22). The effectiveness in walking, however, must be considerably greater in the lighter Anhinga. Measurements involving the height of the hypotarsus are important. Leverage in extension of the tarsometatarsus is in large measure proportional to the hypotarsal height. It will be seen (Table 17) that the average height of the latter, expressed as a percentage of tarsometatarsal length, has almost identical values in the two species. The lengths of the surface of insertion of the hypotarsus are not very different but this surface, in proportion to the length of the tarsometatarsus, is somewhat longer in the cormorant.

M. GASTROCNEMIUS, PARS MEDIA

General.—This muscle is, in part, superficial upon the inner surface of the shank (Figs.

30-34). The belly of *M. plantaris* is closely applied to the proximal portion of its deep surface.

Origin.—Largely fleshy from the dorsal surface of the internal condyle of the distal femoral head (Fig. 40); fleshy from the dorsal surface of the inner head of the tibia and for a variable distance from the mesial surface of the tibial shaft (Fig. 41). The origin is variably fused with the insertion of *M. adductor profundus*.

Insertion.—A flat tendon may be formed along the lateral surface of the belly; this inserts dorsally upon the belly and tendon of insertion of the internal head (Fig. 32). Fleshy insertion is also made upon the internal head.

Action.—Any flexion of the tibia as a result of the femoral origin of this muscle must be slight. The muscle must augment the action of the internal head. Miller (1937: 34) suggested that it opposes any rotation of the femur that might be caused by the external head.

Comparison.—Relative volumes are similar in the two species (Table 22). There is a greater area of fleshy insertion upon the internal head in the cormorant.

M. PERONEUS LONGUS

General.—This flat muscle, lying along the ventral half of the distolateral surface of the shank (Figs. 28, 29), has fleshy connections with the belly of *M. flexor perforans et perforatus digiti III*, which lies dorsal to it. Its ventral margin is superficial to the bellies of *Mm. tibialis anterior* and *peroneus brevis*. Aponeurotic connections exist with many of the toe flexors which originate upon the shank.

Origin.—From an extensive aponeurosis, which attaches in part to the lateral ventral margin of *M. gastrocnemius, pars interna*, the tibial shaft, the lateral surface of *M. tibialis anterior*, the lateral surface of the outer cnemial crest, and the fibula (Figs. 28, 29). Fleshy origin also is from the lateral and dorsal surfaces of the distal half of the fibula and from the lateral surface of the outer cnemial crest (Fig. 41).

Insertion.—The ventral portion of the belly gives rise to a tendon, which fuses along the proximolateral surface of the tarsometatarsus with the tendon of *M. flexor perforans et perforatus digiti III*. The dorsal portion of the belly has a stout, mixed insertion upon the tibial cartilage (Figs. 28, 29).

Action.—Flexion of digit III; tarsometatarsal abduction and extension.

Comparison.—The origin from the fibula is more extensive in the cormorant.

Discussion.—Miller (1937: 37) called attention to rotation of the leg effected by *M. gastrocnemius*, and he believed that abduction of the tarsometatarsus by *M. peroneus longus* may be of importance in opposing this force. This muscle was found to be large in *Nesochen*. Similar correlations may exist with respect to the Anhinga and the cormorant. In these, the hypotarsal surface of insertion of *M. gastrocnemius* faces dorsolaterally; furthermore, the internal head of *M. gastrocnemius* lies largely upon the mesial-facing half of the shank. In the Anhinga, the internal head of *M. gastrocnemius* is relatively larger than the external head; this is not the case in the cormorant. The apparent tendency towards slightly larger size of *M. peroneus longus*, then, in the Anhinga is possibly correlated with the relatively greater development of the internal head of *M. gastrocnemius*.

M. TIBIALIS ANTERIOR

General.—This large, superficial muscle extends the length of the ventral surface of the shank (Figs. 28-30). *M. extensor digitorum longus* lies deep to it.

Origin.—A dorsal head has tendinous origin from the distal end of the external condyle of the femur (Fig. 40) and may have fleshy connections with the outer cnemial crest.

The larger ventral head takes fleshy origin from the lateral half of the ventral surface of the patella (Fig. 43), from the lateral surface of the outer cnemial crest of the tibia, from the ventral surfaces of the outer cnemial crest, from the ventral surface of the fibular crest, and from a short portion of the tibial shaft caudal to the last (Fig. 41). Fleshy connections are also made with the proximal portion of *M. gastrocnemius, pars interna*, which lies contiguous to it, and with *M. extensor digitorum longus*, which lies deep to it. Extent of these areas of origin is somewhat variable.

Insertion.—A stout, calcified tendon is formed at the distal end of the shank. This passes first through a tendinous loop and then superficial to the supratendinal bridge. It inserts within the anterior fossa of the tarsometatarsus lateral to the tendon of *M. extensor digitorum longus* (Fig. 35). The tendon bifurcates immediately proximal to its insertion.

Action.—Flexion of the tarsometatarsus. The dorsal head, which originates from the femur, may also flex the tibiotarsus.

Comparison.—The volume of the muscle is similar in the two species (Table 22).

There are differences in the areas of origin. In the cormorant, the patellar origins are more cranial and not as extensive as in the Anhinga (Fig. 43), and the origins from the ventral surfaces of the outer cnemial crest, fibular crest, and tibial shaft are not as extensive in the cormorant (Fig. 41).

Discussion.—Since this is the chief flexor of the tarsometatarsus functioning in the recovery stroke from tarsometatarsal extension caused by *M. gastrocnemius*, it is noteworthy that its volume is not comparatively greater in the cormorant, in which *M. gastrocnemius* is of such comparatively large size. Measurements of the power arm, the distance along the tarsometatarsus to the point of insertion, in three specimens of each species indicate that this is slightly shorter in the Anhinga, being 20.9 per cent of the weight arm in the latter and 22.4 per cent of this in the cormorant. Thus in the cormorant the muscle has a slightly slower but more powerful action, in the Anhinga a slightly speedier action. The development of the muscle in the Anhinga may be correlated with tarsometatarsal extension in progression out of water, during which the muscle acts against the weight of the body; during extension while swimming, the weight factors against which the muscle must operate are not as great.

M. FLEXOR PERFORANS ET PERFORATUS DIGITI II

General.—This is a narrow muscle extending along the length of the lateral surface of the shank (Fig. 28). It lies ventral to *M. gastrocnemius, pars externa*, and dorsal to *M. flexor perforans et perforatus digiti III*. At its proximal end it has variable fleshy fusion with the latter muscle. Deep to its belly lies *M. flexor perforans et perforatus digiti IV*. The mesial surface of the belly makes attachments to an extensive aponeurosis, which connects many of the digital flexors passing along the shank.

Origin.—Mixed from the femur cranial and proximal to the fibular condyle (Fig. 40). The origin is covered superficially by the tendon of insertion of *M. vastus lateralis*. Mesially the belly is attached to the aponeurosis described above.

Insertion.—The tendon which forms at the distal end of the shank crosses the tarsal joint deep to the tendon of *M. gastrocnemius, pars externa* and passes along the lateral surface of the belly of *M. flexor hallucis brevis*. Proximal to, or at the level of the trochlea for digit II, the tendon penetrates that of *M. flexor perforans digiti II*. Midway along the ventral surface of phalanx 1, the tendon is penetrated by that of *M. flexor hallucis longus*. The two branches of the tendon thus created pass to insert upon either side of the proximoventral surface of phalanx 2 (Fig. 36).

Action.—Flexes digit II, extends the tarsometatarsus upon the tibiofibula, and flexes the tibiofibula upon the femur.

Comparison.—The relative muscle volumes are similar in the two species (Table 22).

In the cormorant, there is apparently a greater degree of fleshy connection with the belly of *M. flexor perforans et perforatus digiti III*.

In the cormorant, the tendon of insertion was not found to be perforated by that of *M. flexor digitorum longus* and thus it is not divided into lateral and mesial branches; a single insertion is made upon the mesial surface of phalanx 2.

Discussion.—More delicate control of the index digit may be effected by the double insertion upon the phalanx in the Anhinga. The action of the muscle in the cormorant may draw the digit laterally as well as flex it.

M. FLEXOR PERFORANS ET PERFORATUS DIGITI III

General.—This is a stout, bipennate muscle of the lateral surface of the shank (Fig. 28). Its dorsal border is contiguous with, and proximally fuses variably with, the belly of *M. flexor perforans et perforatus digiti II*. Its proximal end is expanded and flattened and may also make fleshy connection with *M. tibialis anterior*, which lies ventral to it; the distal portion of the muscle lies dorsal to *M. peroneus longus*, with which it has aponeurotic connections and variable fleshy fusion. Fleshy connections are also made to the belly of *M. flexor perforans digiti IV*, which lies deep to its distal portion.

Origin.—Fleshy from the lateral surface of the inserting tendon of *M. vastus lateralis*, from fascia and ligamentous material covering the lateral surface of the head of the fibula, and by an aponeurosis which has connections with other toe flexors and which arises from much of the length of the dorsolateral surface of the fibula (Fig. 41). Fleshy connections with other muscles are mentioned above.

Insertion.—The wide tendon, which forms at the distal end of the shank, crosses to the tarsometatarsus closely applied to the tendon of *M. flexor perforans digiti III*. One-third

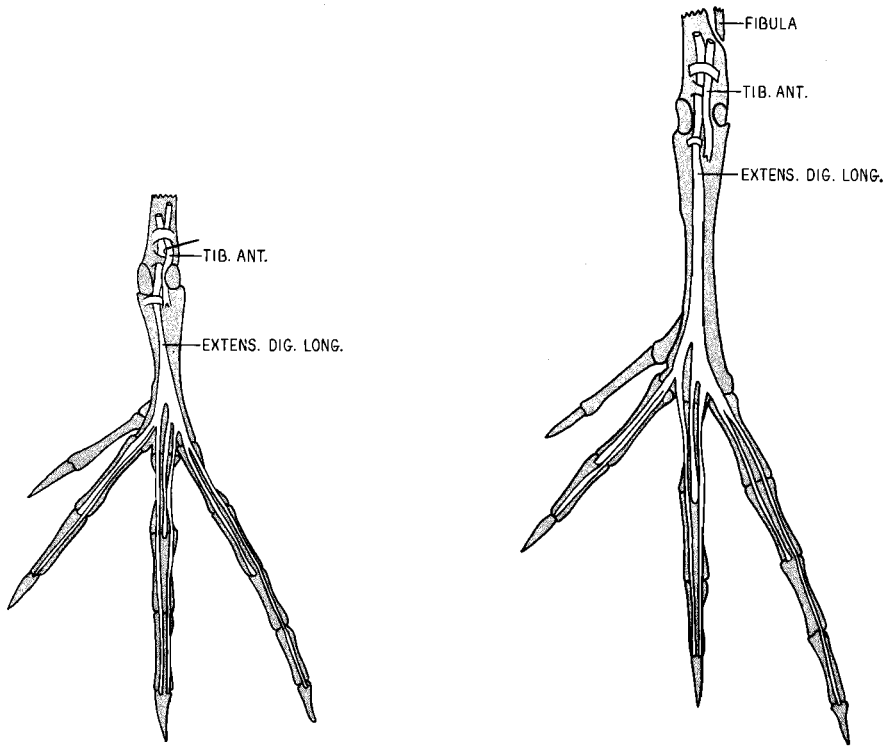

Figure 35. The arrangement of some extensor tendons of the tarsometatarsus and the digits of the Anhinga (left) and the cormorant.

of the length along the tarsometatarsus, the tendon is joined by that of *M. peroneus longus* (Fig. 29). At or somewhat proximal to the level of the trochlea for digit III, the tendon is crossed by the lateral branch from the bifurcation of the tendon of *M. flexor perforatus digiti III*. At the level of the proximal end of phalanx 2, the tendon is perforated by that of *M. flexor digitorum longus*. The two branches of the tendon thus created insert upon either side of the proximoventral surface of phalanx 3 (Fig. 36).

Action.—Flexes digit III; flexes phalanx 3 against phalanx 2 of this digit; extends the tarsometatarsus; may cause some tibiotarsal flexion since connections are made by the muscle with the tendon of *M. vastus lateralis*.

Comparison.—This is a significantly larger muscle in the cormorant (Table 22).

In the Anhinga, the tendon is crossed by a branch of the already bifurcated tendon of *M. flexor perforans digiti III*; in the cormorant, the tendon creates the bifurcation of the latter tendon by its penetration of it.

Discussion.—The importance of this muscle in toe flexion and in tarsometatarsal extension during swimming may be slightly greater in the cormorant. The many interconnections of the muscle with other toe flexors, as well as with other groups of muscles, obscure correlation of the muscle's development with differences in habits of the two species.

M. FLEXOR PERFORATUS DIGITI IV

General.—The belly of this deep muscle of the shank (Fig. 29) is formed from fusion of a large dorsal and a small ventral head, both portions being innervated by branches

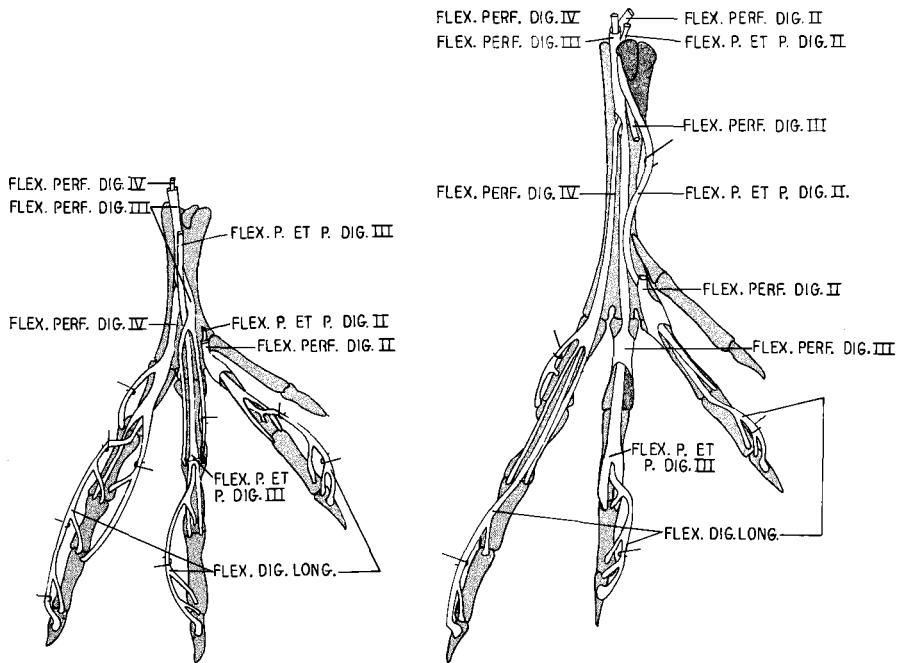

Figure 36. The arrangement of some tendons flexing the digits of the Anhinga (left) and the cormorant.

of the same nerve. The extensive flexor aponeurosis is closely applied to the deep surfaces of the belly.

Origin.—The dorsal portion has fleshy origin from the popliteal area of the femur (Fig. 40); the ventral portion has its entire origin upon the underlying flexor aponeurosis.

Insertion.—The tendon, forming at the level of that of *M. flexor perforatus digiti III*, is enclosed, in whole or in part, by the latter tendon to a point distal to the hypotarsus (Figs. 29, 36). The tendon then passes obliquely to the lateral side of the tarsometatarsus and widens as it crosses the trochlea for digit IV. Along phalanx 1 or phalanx 2 the tendon is perforated by that of *M. flexor digitorum longus*. The lateral and mesial branches of the tendon which are thus created pass to their insertions upon corresponding sides of the proximoventral surfaces of phalanx 3. Proximal to perforation by the tendon of *M. flexor digitorum longus*, a small tendon is given off laterally which passes to its insertion upon the midventral surface of phalanx 1 and upon the proximolateral surface of phalanx 2.

Action.—Flexes digit IV, phalanx 3 being flexed against phalanx 2, phalanx 2 against phalanx 1, and phalanx 1 against the tarsometatarsus; extends the tarsometatarsus; flexes the tibiofibula.

Comparison.—This muscle is significantly larger in the cormorant, its volume relative to the total leg musculature being almost twice as great as in the Anhinga (Table 22).

Discussion.—Larger size of this muscle in the cormorant is correlated with the greater length of digit IV in this species. Greater force is necessary for flexion of this portion of the web during the power stroke of swimming.

M. FLEXOR PERFORATUS DIGITI III

General.—The lateral surface of the muscle lies deep to *M. flexor perforatus digiti IV* (Fig. 30). The large dorsal portion of the belly extends along the distal half of the shank; the small ventral portion is restricted to the distal fifth or so of the shank.

Origin.—The muscle arises from the extensive aponeurosis to which many of the toe flexors passing along the shank are connected. The dorsal portion of this aponeurosis arises from a prominence of the posterior surface of the femur (Fig. 40). Ventrally the aponeurosis is attached to the dorsal surface of the fibula along most of its length (Fig. 41) and to the lateral surface of the external femoral condyle distal to the origin of *M. flexor perforans et perforatus digiti II*. The tendon of *M. ambiens* passes deep to, and fuses with, this aponeurosis.

Insertions.—The wide tendon is formed by the union of the tendons of the dorsal and ventral portions; it encloses wholly or in part the tendon of *M. flexor perforatus digiti IV* to a point distal to the hypotarsus. As it crosses the tarsal joint, the tendon of *M. flexor perforans et perforatus digiti III* is more or less closely applied to its lateral surface. Crossing the latter joint the tendon lies in a groove in the dorsal surface of the tibial cartilage. Proximal to or distal to the trochlea for digit III, the tendon is perforated by that of *M. flexor perforans et perforatus digiti III*. Mesial and lateral branches thus created pass to insertions upon the proximoventral surfaces of the corresponding sides of phalanx 2 (Fig. 36).

Action.—Digit III is flexed, phalanx 2 being flexed against phalanx 1; the tarsometatarsus is extended; the tibiotarsus is flexed against the femur.

Comparison.—This muscle is relatively larger in the Anhinga than in the cormorant (Table 22).

Discussion.—Miller (1937: 37) found correlation in the bulk of the toe flexors with the sizes of the toes. Similar correlations are apparent in the Anhinga and the cormorant.

M. FLEXOR PERFORANS DIGITI II

General.—This is a small, flattened, tapering muscle lying deep to *M. flexor perforatus digiti III* and dorsal or superficial to *Mm. flexor digitorum longus* and *flexor hallucis longus* (Fig. 31).

Origin.—Immediately mesial to the origin of *M. flexor hallucis longus* from the popliteal area of the femur (Fig. 40).

Insertion.—The tendon passes through the central portion of the tibial cartilage ventral to that of *M. flexor hallucis longus*. Proximal to the trochlea for digit II the tendon is perforated by that of *M. flexor perforans et perforatus digiti II*. A strong insertion passes to the proximolateral surface of phalanx 1 and a weak insertion to the proximomesial surface of that phalanx (Fig. 36).

Action.—Flexes and adducts digit II; extends the tarsometatarsus; flexes the tibiofibula.

Comparison.—The relative bulk of the muscle is similar in the two species. The belly is somewhat shorter in the Anhinga.

M. FLEXOR HALLUCIS LONGUS

General.—This is a large, deep muscle of the shank (Fig. 31). It lies deep, in part, to *M. flexor perforatus digiti II* and superficial to *M. flexor digitorum longus*.

Origin.—Fleshy by two heads, one from the dorsal surface of the fibular head and from a contiguous area of the head of the tibia (Fig. 41), and one from the popliteal area of the femur (Fig. 40).

Insertion.—The tendon passes through the central portion of the tibial cartilage dorsal to the tendon of *M. flexor perforatus digiti II* and then through a bony groove immediately mesial to the small lateral calcaneal ridge of the hypotarsus. A large branch of the tendon inserts upon the distal phalanx of digit I. An extensive vinculum passes to the branches of insertion of *M. flexor digitorum longus*. Variation was found with respect to the connections with the latter muscle. Connections to the branch of *M. flexor digitorum longus* passing to digit II may contribute more material than is contributed by the branch of *M. flexor digitorum longus* itself. In two Anhingas, the tendon of *M. flexor hallucis longus* bifurcated midway along the tarsometatarsus. The lateral branch inserted upon the branches of *M. flexor digitorum longus* passing to digits III and IV. The branches of the mesial bifurcation passed to digit I and to digit II, the branch to digit II being the sole such flexor muscle passing to insertion upon that digit, *M. flexor digitorum longus* in this case only contributing to digits III and IV. Connections of the muscle with the tendons of *M. flexor digitorum longus* are shown in Figure 37.

Action.—Augments flexion of digits II, III, and IV by *M. flexor digitorum longus*. Flexes digit I. It must also bring about flexion of digits II, III, and IV, or increase tension of flexion of these, when digit I is flexed by it. The muscle action may also contribute to tarsometatarsal extension and tibiotarsal flexion.

Comparison.—The muscle is significantly larger in the Anhinga (Table 22). Variations found in the attachments of the muscle to *M. flexor digitorum longus* in the Anhinga were not apparent in the cormorant.

Discussion.—See *M. flexor digitorum longus*.

M. FLEXOR DIGITORUM LONGUS

General.—This is a large muscle, which lies along the dorsal surface of the tibiotarsus and the fibula (Fig. 31). The belly lies deep to *Mm. flexor hallucis longus* and *flexor perforatus digiti II*.

Origin.—By two fleshy heads: the lateral one arising from the dorsal surface of the proximal half of the fibula distal to the fibular head; the mesial head from the tibia distal to the enlarged portion of the tibial head. Origin is also taken from the dorsal surface of the fibular crest and from the greater length of the dorsal surface of the tibia (Fig. 41).

Insertion.—The tendon passes deep within the tibial cartilage (Fig. 31) and through a bony canal on the lateral surface of the large mesial calcaneal ridge of the hypotarsus. Proximal to the trochleae, the tendon trifurcates, branches passing to digit III, digit IV, and, variably, to digit II. Branches to these digits are joined by connections from the tendon of *M. flexor hallucis longus*. After penetrating the tendon of *M. flexor perforans digiti IV* and tendons from *Mm. flexor perforans et perforatus* to digits III and II, each branch passes to insert on the flexor prominence of the ungual phalanx of the particular digit. Proximal to this, each gives off a stout connection to the proximal end of the ungual phalanx and to some point of the ventral surface of the penultimate phalanx as well as the antepenultimate phalanx. There is some variation not only in the regularity of occurrence of these insertions but in their locations as well; and their attachments may, to a large extent, be to the synovial sheathes. The insertions are shown in Figure 36; the connections with *M. flexor hallucis longus* in Figure 37.

Action.—Flexion of digits II, III, and IV, particularly their distal phalanges. Action is augmented by that of *M. flexor hallucis longus*.

Comparison.—This is a significantly larger muscle in the Anhinga (Table 22), in which it has more extensive origins (Fig. 41).

Discussion.—Habits of a more arboreal nature in the Anhinga and a different type of specialization for aquatic progression in the cormorant are reflected in the development of *Mm. flexor hallucis longus* and *flexor digitorum longus*. The relatively larger volume of the former is significant with respect to flexion of the hallux as in perching. At this time, connections of the muscle with *M. flexor digitorum longus* result in flexion, or increased tension of this, in the toes which oppose the hallux. *M. flexor digitorum longus* is important in flexing distal phalanges, such action being important in climbing and perching. During perching, when the weight of the bird does not necessarily rest uniformly upon all of the toes or toe surfaces, flexion of subdistal phalanges must be of importance; it would be interesting to ascertain the extent of the insertion upon the subdistal phalanges of a wider sampling of the two species.

The variation found in the contribution of *M. flexor hallucis longus* to flexion of digit II suggests that simultaneous action of toe flexors, as would seem required in swimming, is not under strong selective pressure in the Anhinga; rather, more independent positioning of the toes, as in perching and climbing, would be important here.

M. LUMBRICALES

General.—Fleshy fibers of this muscle, as described by Fisher (1946: 682) in the New World vultures, could not be demonstrated in the Anhinga or in the cormorant.

M. POPLITEUS

General.—This is an extremely small muscle passing between the fibular and tibial heads (Fig. 41).

Origin.—Fleshy from the tibial head (Fig. 41).

Insertion.—Fleshy from the fibular head (Fig. 41).

Action.—Draws the fibular head mesially.

Comparison.—Difficulty in removing the muscle makes measurement inexact. It appears to be slightly less extensive in the Anhinga.

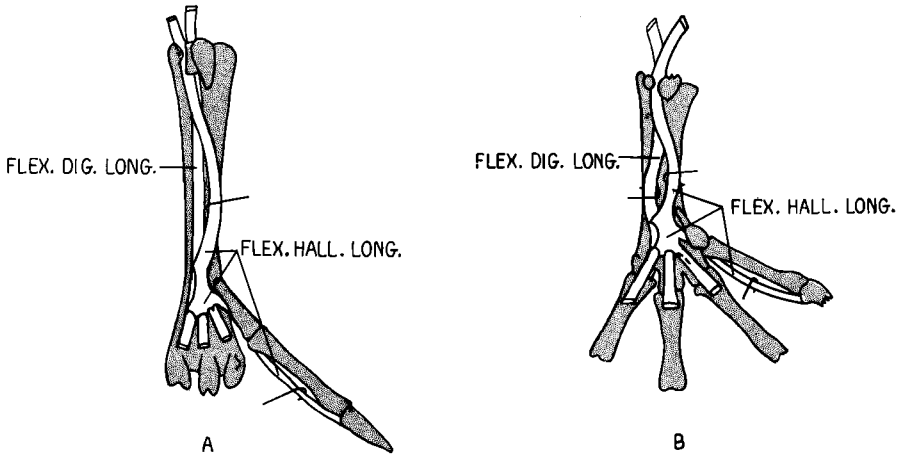

Figure 37. The arrangement of the tendons of insertions of *Mm. flexor digitorum longus* and *flexor hallucis longus* in the cormorant (A) and the Anhinga (B).

M. PERONEUS BREVIS

General.—This is a small muscle of the ventral portion of the distal half of the shank (Figs. 28, 29). The bulk of its belly lies deep to *M. peroneus longus*; the extreme distal end is in superficial view.

Origin.—(Fig. 41). Fleishy from the distal half or so of the ventral surface of the fibula; there is also an origin from the tibia, and this may exceed in area the fibular origin.

Insertion.—The tendon forms at the distal end of the tibiotarsus and crosses onto the tarsometatarsus deep to the fascia encasing the dorsal surface of the latter. Insertion is upon a projection of the lateral surface of the proximal head of the tarsometatarsus (Figs. 29, 42).

Action.—Abduction and possibly slight extension of the tarsometatarsus.

Comparison.—The area of tibial origin is somewhat greater in the Anhinga, in which species the fibula terminates at a more proximal point along the tibiotarsus; distal to the fibula the origin arises from the tibia.

Discussion.—Various opinions as to the importance of *M. peroneus brevis* have been advanced. Obvious significance would seem to be tarsometatarsal abduction, although Miller (1937: 35) suggested that it might act as a brace in opposing action of *M. gastrocnemius*. Mitchell (1913: 1042) suggested it might be important in rotation of the foot. Regardless of what actions it may contribute to, there should be correlation with its development and the differences in morphology and foot action of these totipalmate birds. Such correlation does not seem readily apparent; a better understanding of synergistic relationships is no doubt necessary.

M. EXTENSOR DIGITORUM LONGUS

General.—This large muscle lies along the ventral surface of the tibia (Figs. 30, 31). Its lateral surface lies deep to *M. tibialis anterior*; the mesial surface is covered by *M. gastrocnemius, pars interna*.

Origin.—Fleishy upon the lateral surface of the inner cnemial crest, the mesial surface of the outer cnemial crest, the tibial surface between these crests, and the greater length of the ventral surface of the tibia (Fig. 41). Patellar origin was found only in the cormorant (see below). Attachments are also made to an aponeurosis, which attaches to the mesial surface of the tibia and passes along the deep surface of *M. gastrocnemius, pars interna*.

Insertion.—The stout tendon forms beneath or distal to the tendinous loop enclosing the tendon of *M. tibialis anterior*; it passes beneath the supratendinal bridge and beneath a tendinous loop which crosses the mesial half of the proximal end of the anterior

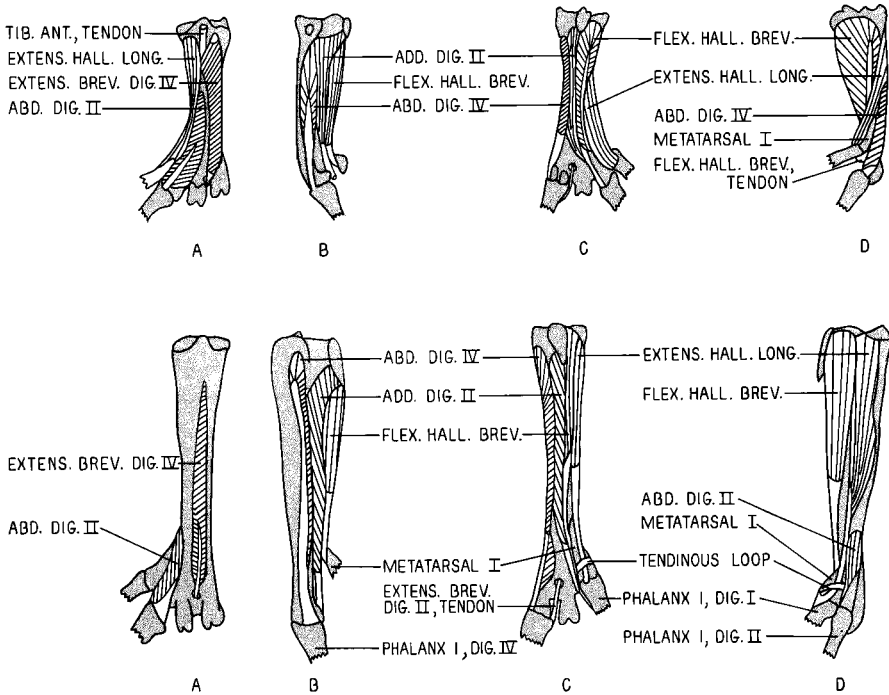

Figure 38. Muscles of the tarsometatarsus of the Anhinga (*top*) and the cormorant. A, B, C, and D represent anterior, lateral, posterior, and mesial views, respectively.

tendinal groove of the tarsometatarsus. Two-thirds of the distance along the tarsometatarsus the tendon bifurcates. Its branches and those along the tarsometatarsus subsequent to them are joined in an extensive vinculum which extends onto the dorsal surfaces of the trochleae and the basal phalanges. From the lateral branch three branches arise. The most lateral passes mesial to the trochlea for digit IV, passes to the lateral side of that digit along phalanges 1 and 2 and inserts upon the unguis phalanx. The middle branch passes laterally along digit III to insert upon the unguis phalanx. The mesial branch passes sagittally down digit III to insert upon the proximal end of phalanx 3; this tendon widens across the articulation between phalanges 1 and 2 and narrows distal to this. The mesial branch of the original bifurcation divides initially into two branches. The lateral of these may be followed down the mesial surface of digit III to its insertion upon the unguis phalanx. The mesial branch divides at the level of the trochlea for digit II; its branches insert upon the proximal end of phalanx 2 and upon the unguis phalanx (Fig. 35).

Action.—Extends digits II, III, and IV; abducts digit IV; flexes the tarsometatarsus.

Comparison.—This is a significantly smaller muscle in the Anhinga (Table 22).

In the cormorant the origin from the patella arises from the ventral third of the latero-distal portion of that bone (Fig. 43); a patellar origin was not found in the Anhinga.

Discussion.—Among the geese he examined, Miller (1937: 38) found this muscle least developed in *Nesochen*. He postulated that freedom of the distal phalanges from the web might result in an easing of the load on this muscle with resultant comparative decrease in bulk. It is therefore noteworthy that the muscle is smaller and has less extensive attachments in the Anhinga, in which the webbing is reduced.

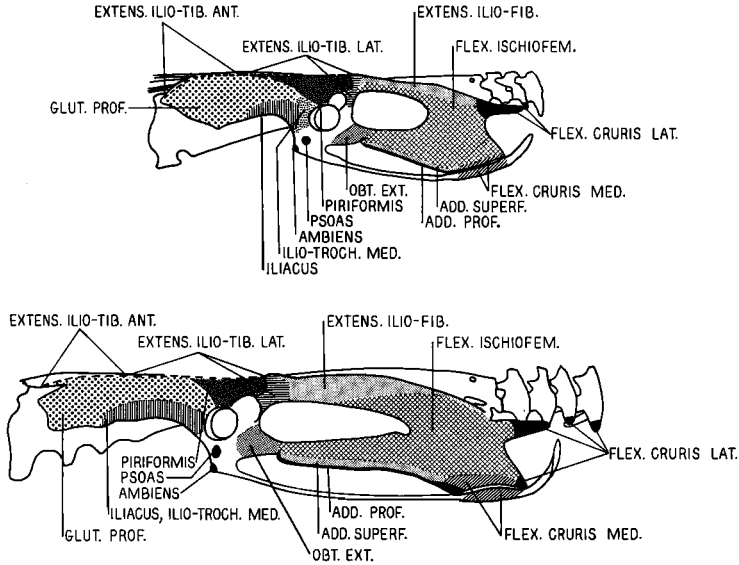

Figure 39. Muscle origins and insertions upon the tarsometatarsus of the Anhinga (*top*) and the cormorant.

M. PLANTARIS

General.—This small muscle is closely applied to the deep surface of *M. gastrocnemius, pars media*; its belly extends along the proximal third or so of the shank (Fig. 32).

Origin.—Fleshy from the dorsal surface of the inner tibial head (Fig. 41).

Insertion.—The long, slender tendon is closely applied to the deep surfaces of *M. gastrocnemius, pars media* and *pars interna*. Insertion is upon the mesioventral corner of the tibial cartilage.

Action.—Draws the tibial cartilage forward. This would occur presumably when the tarsometatarsus is extended. It probably effects weak tarsometatarsal extension as well.

Comparison.—There is apparently a greater degree of fleshy connection of this muscle to *M. gastrocnemius, pars media* in the cormorant.

The relative volume of the muscle is "probably" significantly greater in the Anhinga (Table 22).

Discussion.—A greater degree of independent action of this muscle may exist in the Anhinga as a result of its comparatively less extensive fusion with *M. gastrocnemius, pars media*.

Correlation of the comparative differences of the muscle with differences in progression are not readily apparent, although its greater extent in the Anhinga may be correlated with its action in elevating the tibial cartilage during tarsometatarsal extension. The latter is more extreme during walking than during swimming.

M. EXTENSOR PROPRIUS DIGITI III and M. EXTENSOR BREVIS DIGITI III

These muscles could not be found in the Anhinga or the cormorant.

M. EXTENSOR HALLUCIS LONGUS

General.—The belly of this muscle extends from the anteroproximal half of the tarsometatarsus obliquely distomesially to the dorsal surface of the basal phalanx of digit I (Fig. 38). The belly passes along the posterior surface of metatarsal I, origin from which could not be demonstrated.

Origin.—Fleshy from proximal portions of the mesial and anteromesial surfaces of the tarsometatarsus (Fig. 42). The origin extends into the anterior tendinal groove and meets that of *M. extensor brevis digiti IV*.

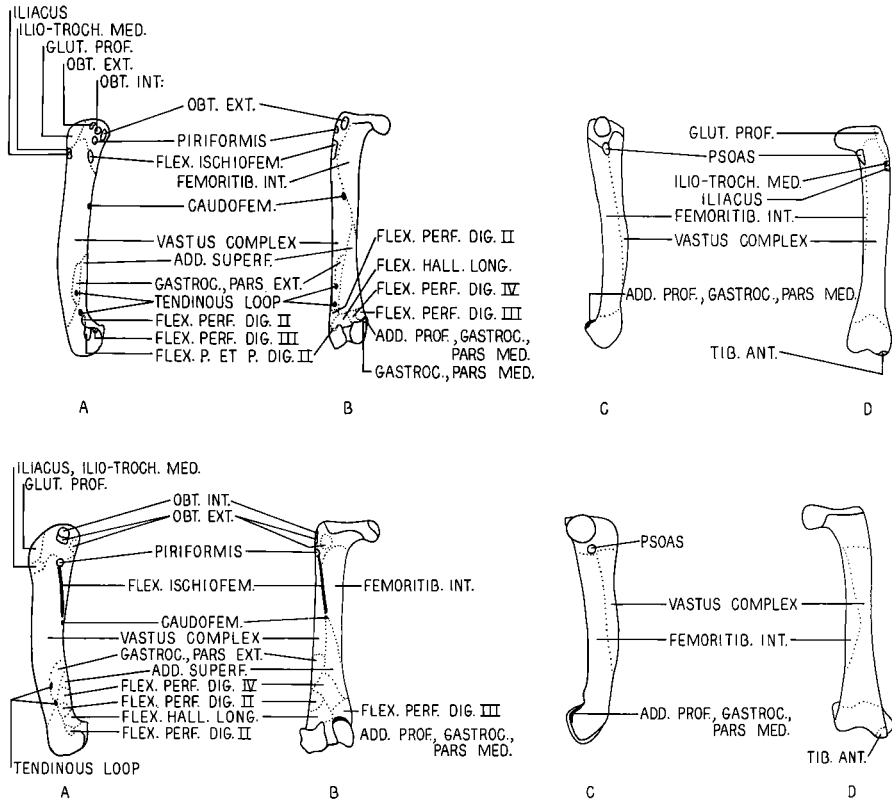

Figure 40. Muscle origins and insertions upon the left femur of the Anhinga (*top*) and the cormorant. A, B, C, and D represent lateral, posterior, mesial, and anterior views, respectively.

Insertion.—By a short tendon to the dorsal surface of phalanx 1 of digit I.

Action.—Extends digit I and moves it forward.

Comparison.—In the Anhinga, the belly passes obliquely from the anterior surface of the tarsometatarsus to its posterior surface; the greater portion of the origin is from the anterior surface. In the cormorant, the muscle is entirely mesial and posterior in position. In one of the four cormorants dissected, however, the anterior border of the central portion of the muscle extended to the anterior edge of the tarsometatarsus.

In the cormorant, the tendon of insertion is long and passes through a tendinous loop extending across the expanded articular head of metatarsal I. The tendon of insertion is very short in the Anhinga and the tendinous loop described above could not be demonstrated. In one cormorant, the tendon of insertion bifurcated distal to the tendinous loop, and the branches inserted on opposite sides of the dorsal surface of phalanx 1.

Discussion.—The position of this muscle indicates that the force exerted by it in the Anhinga would tend to move the digit anteriorwards; the positions of the origin in the cormorant indicate that the effective force of this muscle serves largely for extension of the digit.

M. ABDUCTOR DIGITI II

General.—This muscle lies along the mesial half of the distal end of the anterior surface and along the distal portion of the mesial surface of the tarsometatarsus (Fig. 38).

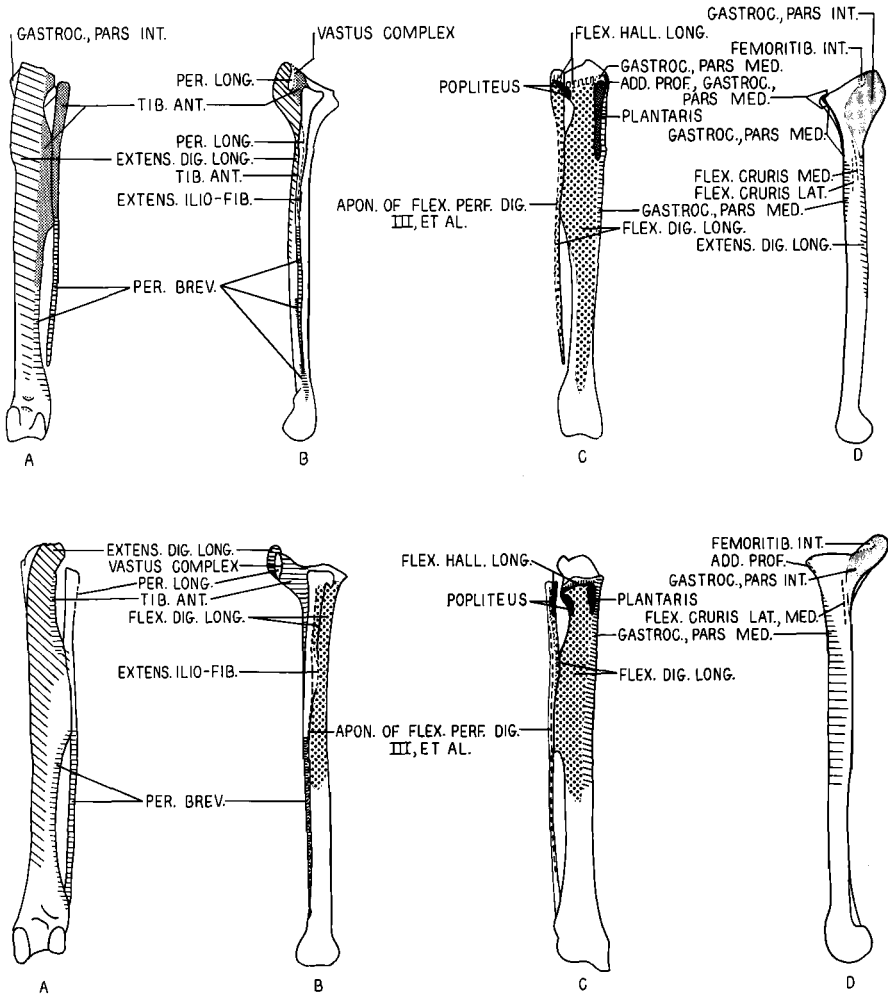

Figure 41. Muscle origins and insertions upon the left tibio-fibula of the Anhinga (*top*) and the cormorant. A, B, C, and D represent ventral, lateral, dorsal, and mesial surfaces, respectively.

Origin.—Fleshy from the distal half of the mesial half of the anterior surface and from a small area of the extreme distomesial end of the tarsometatarsus (Fig. 42). Weak origin from metatarsal I was found in some specimens of both species.

Insertion.—By a wide tendon to the proximomesial surface of phalanx 1 of digit II (Fig. 38).

Action.—Abducts digit II.

Comparison.—Relative volume of this muscle in the Anhinga is *three times greater* than in the cormorant (Table 22).

The origin extends for more than half the length of the tarsometatarsus in the Anhinga; in the cormorant, it extends for considerably less than this distance. In the Anhinga, the origin is from the mesial side of the tarsometatarsus lateral to the central portion of this

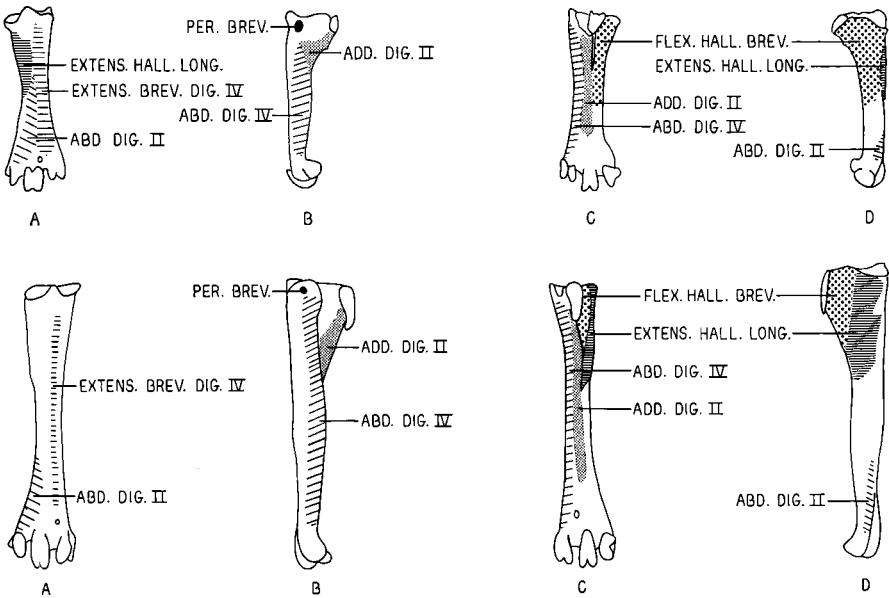

Figure 42. Muscle origins and insertions upon the left tarsometatarsus of the Anhinga (*top*) and the cormorant. A, B, C, and D represent anterior, lateral, posterior, and mesial views, respectively.

bone; the origin from the anterior surface of the tarsometatarsus is not as extensive in the cormorant.

Discussion.—The relative positions of origin would indicate a greater effectiveness of abduction in the Anhinga. The relative volumes indicate a greater force of abduction in the Anhinga. Abduction of this digit is important in positioning of the toes.

M. EXTENSOR BREVIS DIGITI IV

General.—This is a stout muscle of the lateral half of the anterior surface of the tarsometatarsus (Fig. 38).

Origin.—Tendinous from the proximal margin of the anterior tendinal groove lateral to the tendon of *M. tibialis anterior*; distal to this the origin is fleshy from the lateral surfaces of the groove and may spread mesially into the groove (Fig. 42). The proximal portion of the fleshy origin may extend mesially and meet the origin of *M. extensor hallucis longus*.

Insertion.—The tendon forms along the deep surface of the belly. It passes through the distal foramen, around the mesial surface of the trochlea for digit IV, and widens proximal to insertion upon the proximomesial corner of phalanx 1 of digit IV.

Action.—Adducts and extends digit IV.

Comparison.—The relative volume of this muscle is larger in the Anhinga, a value of "possible" significance (Table 22).

The proximal portion of the belly and its area of origin are conspicuously less developed in the cormorant.

Discussion.—Fisher (1946: 689) stated that he could not see how this muscle might effect extension of the digit except from the extreme flexed position. Extension of the digit, even from a weakly flexed position, can be clearly demonstrated, however, in the Anhinga.

The greater volume of this muscle in the Anhinga, particularly noteworthy in consideration of the greater length of this digit in the cormorant, can be correlated with the greater degree of perching and walking in the Anhinga.

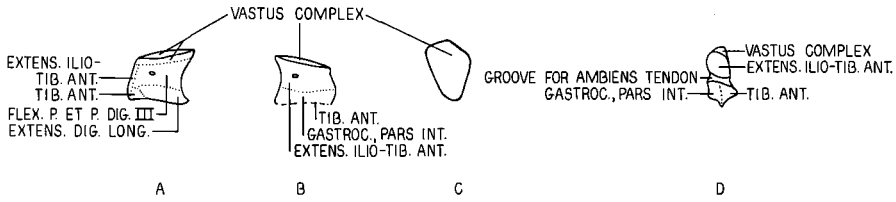

Figure 43. Muscle origins and insertions upon the left patella of the cormorant (A, B, C) and the Anhinga (D). A, B, C, and D represent lateral, mesial, dorsal, and anterior views, respectively.

M. ADDUCTOR DIGITI II

General.—This is a relative weak muscle, which passes from the lateral surface of the hypotarsal ridge along the dorsal or posterior surface of the tarsometatarsus to digit II (Fig. 38). The belly meets on its lateral and mesial sides those of *Mm. abductor digiti IV* and *flexor hallucis brevis*, respectively.

Origin.—Fleshy from the lateral surface of the hypotarsal ridge, from the edge of this ridge, from the tarsometatarsal shaft lateral and distal to the hypotarsal ridge, and from the distal end of margins of the bony canal containing the tendon of *M. flexor digitorum longus* (Fig. 42).

Insertion.—The weak tendon forms at the level of the mid-point of metatarsal I, passes deep to the distal portion of the latter, along the lateral surface of the trochlea for digit II, and inserts upon the proximolateral surface of phalanx I.

Action.—Adduction of digit II.

Comparison.—The relative volume of this muscle is twice as great in the Anhinga (Table 22), a significant difference.

Discussion.—As with the other short toe muscles, the relatively greater development of this muscle in the Anhinga can be correlated with the greater digital dexterity concomitant with arboreal progression.

M. FLEXOR HALLUCIS BREVIS

General.—This is the largest muscle of the tarsometatarsus (Fig. 38). It passes from the mesial surfaces and from mesial to the hypotarsus to the proximal phalanx of digit I. *M. extensor hallucis longus* parallels its mesial surface; *M. adductor digiti II* lies deep to its lateral border.

Origin.—Fleshy from the lateral surface of the hypotarsus and from the surface of the tarsometatarsus mesial and distal to this (Fig. 42).

Insertions.—The tendon forms proximally along the superficial surface of the belly. It passes along the deep surface of the articulating head of metatarsal I within an irregular groove upon the latter. The tendon widens greatly immediately proximal to its insertion upon the proximoventral surface of phalanx I (Fig. 38). The tendon of *M. flexor digitorum longus* is closely applied to this tendon as it passes along the surface of metatarsal I.

Action.—Flexes the hallux and moves it laterally; extends metatarsal I.

Comparison.—The relative volume of this muscle in the Anhinga is *three times greater* than in the cormorant (Table 22).

The belly is relatively longer, and wider and takes origin from a relatively much more extensive area of the tarsometatarsus in the Anhinga.

Discussion.—The relatively much greater development of this muscle in the Anhinga is correlated with flexing of the hallux when it is moved into opposition to the other three toes during perching; the hallux, by virtue of reduction of the web attaching to it, has a far greater degree of independent action.

M. ABDUCTOR DIGITI IV

General.—This muscle passes along the length of the lateral portion of the posterior surface of the tarsometatarsus (Fig. 38).

Origin.—Fleshy from the length of the posterolateral surface of the tarsometatarsus (Fig. 42).

Insertion.—The tendon forms along the superficial surface of the belly approximately one-third distal to the origin of the muscle. It crosses the lateral surface of the trochlea for digit IV and inserts upon the anterolateral surface of phalanx 1 (Fig. 38).

Action.—Abduction of digit IV.

Comparison.—This is a significantly larger muscle in the Anhinga (Table 22).

Discussion.—More powerful abduction by this muscle of digit IV is indicated in the Anhinga. This can be correlated with the greater degree of dexterity of the toes associated with non-aquatic pedal action.

DISCUSSION AND SUMMARY

The Anhingas and the cormorants obtain their prey underwater. The latter spend much time at the water's surface apparently irrespective of actual fishing activities. Anhingas, however, enter the water for relatively brief periods of fishing or during periods of alarm when they have not had the opportunity to take flight. Anhingas usually enter the water by climbing down to it, by diving into it from overhanging branches, or more rarely, by a belly-landing on the surface after a short gliding flight from a nearby perch; diving from flight is apparently resorted to when flight is insufficient for escape from danger. Cormorants habitually land upon the water from flight.

The Anhinga is a bird of an arboreal-aquatic habitat. After emergence from the water, it usually works its way upwards through the bushes and small trees by hopping, scrambling, and climbing. In a habitat with a high upper story, high perches are usually gained by flying but only after the bird has climbed to an elevation from which it can launch into flight. Anhingas spend considerable portions of the day sunning on exposed, elevated, usually arboreal perches. Cormorants climb with less facility. They may perch in exposed arboreal situations and nest in the dense Red Mangrove thickets of south Florida, but they apparently do not climb from the water into the nesting trees. They do not nest in such small growth as, for example, that comprising willow hammocks, where Anhingas may nest. More commonly one sees cormorants resting upon sandbars, rocks, sloping banks, and upon such broad surfaces as are afforded by bulkheads, buoys, pipelines, etc. The absence of the Anhinga from most marine-littoral areas may be accounted for by the lack of suitable growth for emergence (and lack of suitable conditions for fishing) in these areas. Where these conditions are favorable, as in mangrove areas, Anhingas may be found.

Features of the external anatomy of the pelvic limb can be correlated with the observed differences in habitat of the two species. The webbing between the digits is not reduced in the cormorant. In the Anhinga the webbing is greatly reduced between digits I and II, thus allowing greater freedom of the hallux. Digit IV does not extend as far distally as digit III, and digit IV can be moved laterally to a greater degree than in the cormorant. The nails of the Anhinga are longer and considerably more curved. The tarsometatarsus of the Anhinga is shorter in relation to the total length of the leg than that of the cormorant; it is reminiscent of the short tarsometatarsus found in such perching-climbing birds as parrots.

Osteological features can be similarly correlated. In the cormorant the elongated postacetabular pelvis, the shortened, laterally compressed femur, the extensive development of the trochanteric crest, the elongated patella,

TABLE 22
 VOLUMES OF THE LEG MUSCLES EXPRESSED AS PERCENTAGES OF THE TOTAL VOLUME OF
 THE MUSCLES OF THE LEG¹

Muscle	Anhinga		Cormorant	
	Extremes	Mean	Extremes	Mean
extensor ilio-tibialis lateralis	1.95- 2.40	2.17	1.62- 2.05	1.87
extensor ilio-tibialis anterior**	5.20- 6.65	5.88	3.75- 4.45	4.16
piriformis	0.52- 0.76	0.59	0.69- 0.94	0.79
gluteus profundus	2.05- 3.19	2.79	2.71- 3.53	3.22
iliacus and ilio- trochantericus medius	0.29- 0.62	0.48	0.50- 0.77	0.64
vastus complex***	7.28- 8.31	7.81	5.24- 5.97	5.60
extensor ilio-fibularis	5.83- 9.00	7.63	5.26- 6.29	5.61
flexor cruris lateralis	11.49-13.36	12.46	9.98-11.48	10.49
flexor cruris medialis	1.04- 1.23	1.16	0.97- 1.34	1.16
caudofemoralis	1.17- 1.95	1.59	1.48- 1.78	1.63
flexor ischiofemoralis*	3.77- 4.30	3.96	5.35- 6.03	5.60
adductor superficialis**	3.28- 3.56	3.42	1.87- 2.94	2.30
adductor profundus	2.35- 3.29	2.69	1.19- 1.89	1.62
ambiens**	0.09- 0.17	0.13	0.03- 0.05	0.05
femoritibialis internus	0.78- 1.09	0.91	0.79- 1.17	0.95
obturator externus	0.21- 0.32	0.25	0.19- 0.45	0.31
obturator internus	0.80- 1.13	0.90	1.10- 1.82	1.33
gastrocnemius, pars interna	7.36- 8.78	8.06	8.52- 9.23	8.85
gastrocnemius, pars externa**	5.90- 6.24	6.10	10.68-11.53	11.21
gastrocnemius, pars media	1.82- 2.13	1.97	1.45- 1.73	1.62
peroneus longus	1.54- 2.86	2.07	1.18- 1.63	1.45
tibialis anterior	5.75- 6.26	5.95	6.08- 6.81	6.47
flexor perforans et perforatus digiti II	1.95- 2.36	2.14	2.45- 2.90	2.61
flexor perforans et perforatus digiti III**	2.19- 2.98	2.59	3.48- 4.06	3.76
flexor perforans digiti IV**	3.52- 3.69	3.58	6.04- 6.94	6.56
flexor perforans digiti III**	2.50- 2.74	2.62	2.11- 2.47	2.29
flexor perforans digiti II	0.59- 1.13	0.86	0.82- 0.97	0.90
flexor hallucis longus**	1.46- 1.56	1.55	0.69- 0.99	0.82
flexor digitorum longus**	1.54- 2.03	1.75	1.08- 1.22	1.15
popliteus	0.07- 0.08	0.08	0.10- 0.14	0.12
peroneus brevis	0.23- 0.30	0.28	0.25- 0.47	0.35
extensor digitorum longus**	1.95- 2.32	2.11	2.51- 3.35	2.80
plantaris*	0.37- 0.51	0.42	0.17- 0.32	0.23
extensor hallucis longus	0.29- 0.49	0.36	0.26- 0.35	0.30
abductor digiti II*	0.23- 0.52	0.33	0.07- 0.12	0.10
extensor brevis digiti IV*	0.35- 0.54	0.44	0.19- 0.32	0.23
adductor digiti II**	0.30- 0.41	0.35	0.10- 0.21	0.15
flexor hallucis brevis**	0.92- 1.28	1.04	0.25- 0.42	0.34
abductor digiti IV**	0.35- 0.49	0.42	0.23- 0.25	0.25

¹ Based on averages of muscle volumes of four specimens (two males, two females) each of the Anhinga and the cormorant.

** denotes a possibly statistically significant difference in volumes between the two species, *t* value expressing a probability of between two and five per cent.

*** denotes a statistically significant difference in volumes between the two species, *t* value expressing a probability less than two per cent.

the elongation of digit IV, the flattening of certain phalanges, and the weak ungual phalanges indicate a greater degree of modification for aquatic habitat. Adaptations of the Anhinga which seem to correlate with its greater modification for arboreal habitat are: the wide pelvis, the long femur, the relatively small patella, the wide, laterally flattened tarsometatarsus, the enlarged articular surface of metatarsal I, the length of digit III exceeding that of the other digits, the distal phalanges being shorter in comparison with the length of their basal phalanx, and the greater development of the ungual phalanges.

The total volume of the leg muscles expressed as a percentage of the weight of the bird is indicative of the development of the leg musculature. In the cormorant, the mean of the total volume of the leg musculature of four specimens was 5.01 per cent (extremes: 4.80 and 5.21 per cent) of the weight of the birds. In the Anhinga the total volume of the same number of specimens averaged 3.86 per cent (extremes: 3.39 and 4.21 per cent) of the total weight.

Volumes of individual muscles or groups of muscles expressed as percentages of the total volume of the leg musculature may be examined with reference to the functions of these muscles.

During swimming there is but slight motion of the femur. Muscles which tend to draw the femur backward may be of importance in opposing the force resulting from propulsion which tends to displace the femur forward. *Mm. flexor ischiofemoralis, caudofemoralis, and adductor superficialis*, which function in this manner through direct insertion upon the femur, comprise 9.53 per cent of the total volume of the leg musculature in the cormorant and 8.70 per cent of this in the Anhinga. In the cormorant, the more caudal origins of these muscles with the resultant orientation of their fibers more nearly at right angles to the femur must result in considerably more effective force than is indicated by volumetric comparison.

Femoral extension is more important during non-swimming progression. The femur is drawn forward chiefly by *M. extensor ilio-tibialis anterior*; this is a significantly larger muscle in the Anhinga. *Mm. gluteus profundus, iliacus, ilio-trochantericus medius*, and the anterior portion of *M. extensor ilio-tibialis lateralis* also draw the femur forward. The total volume of these muscles constitutes 11.32 per cent of the leg musculature in the Anhinga and 9.89 per cent of this value in the cormorant.

The femur is rotated and held in balance by *Mm. gluteus profundus, iliacus, and ilio-trochantericus medius*; these are opposed by *Mm. obturator internus, obturator externus, flexor ischiofemoralis, and caudofemoralis*. Together these constitute 12.73 per cent of the leg musculature in the cormorant and 9.93 per cent in the Anhinga. Miller (1937: 23-24) commented upon the relatively smaller volumes of certain of the above muscles in *Nesochen* in comparison with volumes of the corresponding muscles in more aquatic geese. He attributed this difference to greater development of other muscles with a resultant proportional decrease in the bulk of these muscles. Stolpe (1932: 246) pointed out the importance of the muscles which rotate the leg into swimming position beneath the body of *Phalacrocorax*. The leg may be so rotated in the Anhinga, but the leg is lighter and the force of the power-stroke which might tend to oppose this force of rotation is

presumably not as great in the Anhinga as is indicated by the comparative volumes of *M. gastrocnemius*.

Abduction of the femur is accomplished primarily by *M. extensor ilio-tibialis lateralis*. This is relatively larger in the Anhinga. Weak abduction may be caused by *M. piriformis*. *M. ambiens* may function indirectly, but importantly, in this action; it is of significantly greater volume in the Anhinga.

More effective extension and abduction of the thigh is indicated in the Anhinga. Forces rotating the thigh and drawing it backward are greater in the cormorant.

Mm. extensor ilio-tibialis lateralis, extensor ilio-tibialis anterior, and vastus lateralis-vastus medialis are direct extensors of the shank. These represent 11.63 and 15.86 per cent of the total volume of the leg musculature in the cormorant and the Anhinga, respectively. In addition, *Mm. tibialis anterior* (in part), *femoritibialis internus*, and *ambiens* may function in this capacity. Total volumes of all of these extensors comprise 19.10 and 22.85 per cent of the muscle volume of the leg of the cormorant and the Anhinga, respectively. Development of the shank extensors would seem to be correlated with adaptation for non-aquatic progression.

Mm. extensor ilio-fibularis, flexor cruris lateralis, and flexor cruris medialis are direct flexors of the shank. Combined they represent a considerably greater proportion of the total volume of the leg muscles in the Anhinga (21.25 per cent compared with 17.26 per cent). These muscles are effective in opposing the force of extension created by the swimming power-stroke. They also serve to elevate the anterior end of the body during standing and are important, as the foot is lifted from the ground, in walking. The significance of their larger volume in the Anhinga would not seem to be correlated with opposing the force of extension during swimming, since muscles important in the power-stroke are of much less total volume in this species. The importance of these muscles would seem to be in posturing and walking. The significance of indirect flexors of the shank, *M. gastrocnemius, pars externa* and *pars media* and the long toe-flexors originating upon the femur, will be discussed later.

Adduction of the shank is accomplished by muscles important in its flexion. *Mm. flexor cruris lateralis, flexor cruris medialis, and ambiens* effect adduction. *M. extensor ilio-tibialis lateralis* is an indirect adductor. These muscles are of greater combined volume in the Anhinga.

The inner surface of the tibiotarsus is rotated upwards and outwards by *Mm. femoritibialis internus, flexor cruris lateralis, and flexor cruris medialis*. The last two have separate insertions in the Anhinga, which may result in more effective rotation since the insertion of the belly of *M. flexor cruris medialis* in the Anhinga lies ventral to the location of the combined insertion of these muscles in the cormorant. These three muscles represent 14.53 per cent of the volume of the leg muscles in the Anhinga and 12.60 per cent of this in the cormorant. Rotation effected by the above muscles is opposed by *Mm. ambiens* and *extensor ilio-fibularis*, comprising 7.76 and 5.66 per cent of the leg muscles in the Anhinga and cormorant, respectively. Reference has been made to Stolpe's (1932: 246) discussion of the importance of knee and tibiotarsal rotators. The knee rotators were shown to have a comparatively greater volume in the cormorant; this was believed to be

correlated with its greater degree of aquatic adaptation. Tibiotarsal rotation is probably effectively employed by the Anhinga during climbing activities when its feet may be braced sideways against trunks and branches.

Extension of the tibiotarsus, which provides the propulsion stroke in swimming, is effected directly by *M. gastrocnemius*. There are significant differences in size and development of this muscle between the two species. Its total volume represents 21.68 per cent of the total volume of the leg musculature in the cormorant and 16.14 per cent in the Anhinga. The relative development of the heads of *M. gastrocnemius* is important. Because of its area of origin, the external head is of greater importance during swimming. This head is approximately twice as large in the cormorant as in the Anhinga. The internal head, which is important in walking, is larger than the external head in the Anhinga but smaller than the external head in the cormorant. Thus, differences in the relative development of the heads of *M. gastrocnemius* are probably correlated with the differences in locomotion and habits of the two species.

The long toe-flexors, if opposed in digital and tibiotarsal flexion, function indirectly as tarsometatarsal extensors. The relative development of these is discussed beyond.

M. tibialis anterior is the chief flexor of the tarsometatarsus. Tarsometatarsal flexion during swimming is opposed by the water. During walking the tarsometatarsus is flexed and the foot is elevated above the ground during the recovery stroke. In both species it is difficult to correlate the development of the muscle with function. The muscle may have greater effectiveness in the Anhinga than comparative volumes indicate, since the tarsometatarsus is considerably shorter. On the other hand, the shortness of the tarsometatarsus must necessitate moving it through a greater arc in order to elevate the foot in walking. The longer tarsometatarsus in the cormorant indicates more rapid flexion of it, and this must be of importance during take-off from the water. Flexion is also effected by *M. extensor digitorum longus* when this muscle is opposed in digital extension.

M. peroneus brevis is a chief abductor of the tarsometatarsus. *M. peroneus longus* may also be effective in this action. While neither of these is of significantly different size in the two species, their total volume comprises 1.80 and 2.85 per cent of the volume of the leg muscles in the cormorant and Anhinga, respectively.

During the propulsion stroke of swimming, the flexors of the digits oppose the force of the water against the foot web. During walking these flexors provide thrust as the body is shoved forward by the hind limb. The chief source of digital flexion in swimming and walking is provided by the flexors, which originate from the femur and the tibiotarsus. These muscles, together with *M. ambiens* and *M. peroneus longus*, which complement their action, represent 23.60 per cent of the total volume of the leg muscles in the Anhinga and 39.30 per cent in the cormorant. The importance of these muscles in the latter lies chiefly in flexion of the digits during swimming and not during walking. This is evidenced by their long bellies, and the considerable caliber of many of them. Toe flexors modified for terrestrial progression are characteristically short and slim-bellied. Furthermore, the length of digit IV and the lack of development of the

nails in the cormorant are not indicative of a foot predominately modified for terrestrial or arboreal progression.

Although Miller (1937: 37) found no significant differences in the total volumes of the flexors in the Anseriformes he examined, he did find correlation between the lengths of the digits and the volumes of the flexors inserting upon them. Similar correlations may be found in the Anhinga and the cormorant, although the extensive interconnections between the toe flexors make analysis of individual action inexact. *M. flexor perforatus digiti IV* has a relative volume of 6.56 per cent in the cormorant and 3.58 per cent in the Anhinga. The combined volumes of *Mm. flexor perforans et perforatus* and *flexor perforatus* of digits II and III comprise 6.05 and 3.51 per cent, respectively, of the total volume of the leg muscles in the cormorant, and 5.20 and 3.00 per cent of this in the Anhinga.

There are differences in the development of *Mm. flexor hallucis longus* and *flexor digitorum longus*, flexors inserting upon the unguis phalanges. The relative volumes of both are significantly greater in the Anhinga, their combined volumes representing 3.25 per cent of the total volume of the leg muscles in the Anhinga and 1.97 per cent of this in the cormorant. While insertions of the two muscles are variable in the Anhinga, a greater degree of independent action of the digits in this species is clearly indicated.

M. extensor digitorum longus is significantly larger in the cormorant. Its smaller bulk in the Anhinga may be correlated with shorter toes and reduction in webbing.

There are important differences with respect to the muscles which originate upon the tarsometatarsus and insert upon the digits. In almost every case these muscles are of significantly greater relative volume in the Anhinga. Of particular interest is the comparison of *M. flexor hallucis brevis*, which flexes the hallux and moves it laterally. Its volume, relative to the total volume of the leg musculature, is three times greater in the Anhinga. Motility of the hallux is essential in perching birds. Total volumes of all of these tarsometatarsal muscles inserting upon the phalanges, is 1.37 per cent of the volume of the leg muscles in the cormorant and 2.94 per cent in the Anhinga. These larger muscles are indicative of the greater ability of the Anhinga to position its toes.

CONCLUSIONS

The osteology and myology of the pelvic limb indicate that the Anhinga does not exhibit the degree of modification for aquatic progression that the cormorant does. Some of the more obvious osteological features indicative of these conclusions are the comparative lengths and widths of the pre- and postacetabular elements of the pelvis, the proportions of the leg bones, the great differences in the patella, and the lengths and modifications of the phalanges.

Some of the more obvious features of the myology which are indicative of the above conclusions are the significantly different proportions of the parts of *M. gastrocnemius*, the sizes and extent of phalangeal muscles originating from the tarsometatarsus, the arrangement and development of muscles elevating the anterior portion of the body, and the development of muscles moving the femur.

As with the wing, it is difficult to select differences in anatomical features which can be regarded as unquestionably important in determining phylogenetic relationships. However, I am inclined to regard the basic proportions of the pelvis and the limb bones as suggestive of taxonomic groups broader than generic level. Differences in the patella are striking. There are considerable differences in the myology. At present however, myology seems to be of inconclusive use in determination of phylogeny. Berger (1956b: 437) calls attention to lack of knowledge of the relative development, as well as knowledge of the absence or presence, of appendicular muscles throughout the higher categories of avian classification. This seems to be particularly true of the leg muscles.

THE HEAD

Method of Feeding.—Anhingas and cormorants secure their food underwater. The different manner by which each secures fish is indicated by conspicuous differences in the morphology and musculature of both the skull and jaws. These and other differences in structure imply differences in the methods of pursuit of prey as well as in the actual securing of it. In south Florida, where both species may fish the same waters, the differences in foraging methods separate the two species from direct competition for the food supply.

It is well-known that *Phalacrocorax* seizes its prey between its mandibles and that *Anhinga* impales prey. Both species rise to the surface before swallowing. *Anhinga* shakes or jerks its prey free and catches it in mid-air in its open mouth. Both juggle and mouth fish to position them for swallowing head-first.

Fish which the Anhinga has swallowed bear one, or usually two, punctures made by the mandible or mandibles, which are usually held slightly agape as they are thrust into the fish. Close observation of Anhingas submerging unhurriedly has invariably shown that the mandibles are opened slightly prior to submergence, and it is likely that they are held agape underwater. Cormorants which I have watched submerged with their jaws apparently closed.

I have no evidence to indicate that Anhingas catch fish between their mandibles, although this is to be suspected in the case of very small fish. Inspection of these, however, has often shown the body to be punctured. Mackworth-Praed and Grant (1952: 29) stated that the Old World Anhinga may impale fish but that it is more usual for this species to catch them between the mandibles as cormorants do. [Fish in stomachs of *Anhinga rufa* which I collected at Lake Rudolf, Kenya, bore punctures similar to those found in stomachs of *A. anhinga*.] Verheyen (1953: 162) has pointed out that there are contrasting features of the skulls and occipital styles of the Old and New World anhingas. These features may be indicative of important functional differences as well.

The anatomy of the neck of the Anhinga has been investigated by Garrod (1876a: 336–339), Forbes (1882: 210–212), Boas (1929: 113, 153–154, 184–185), and others. The modifications of the cervical vertebrae and muscles, particularly *M. longus colli ventralis*, which make possible the rapid forward motion of the head, have been described, and Boas (1929: 183–184) has described in detail the latter muscle in *Phalacrocorax carbo*. In the cormorant this muscle effects a slower, probably more powerful and evenly distributed force of extension to the more massive, shorter cervical vertebrae. The cervical vertebrae of *Phalacrocorax* cannot be drawn as far dorsocaudad and cannot be arched in position for rapid forward motion as they can be in the Anhinga.

The Anhinga is generally believed to swim rapidly after its prey and, before reaching it, to transfix it suddenly with a rapid forward thrust of the head. I do not believe that the Anhinga usually swims rapidly after its prey. As with many herons it utilizes a sudden thrust of the head in securing prey. This is of obviously greater advantage when stalking than when pursuing prey. In south Florida, the Anhinga frequently, probably usually,

fishes vegetation-filled, often shallow water. (Sloughs with depths of about 18 inches are the shallowest waters in which I have found Anhingas fishing in this area. Usually they fish deeper water than this). Muscles important in the forward propulsion stroke of swimming are markedly less developed in the Anhinga's leg in comparison with those of the cormorant. Anhingas surfacing with fish almost invariably have these transfixed laterally. Punctures in fish found in Anhinga stomachs pass from one side to the other and this does not suggest that the fish was speared as it was swimming away from the bird. All of these considerations suggest that the Anhinga stalks its prey rather than pursuing it. My observations of Anhingas feeding in shallow water suggest that the birds prowl slowly around, through, and under the aquatic vegetation. In open water, they are usually seen moving slowly. Fish in and about the aquatic growth are encountered suddenly or are approached by stealth, and those in the open are probably stalked slowly. The advantage of the sudden impaling thrust of the head seems apparent only if it is assumed that the Anhinga stalks its prey.

The position of the wings and the fanning out of the tail during submerged swimming lend support to the belief that the Anhinga usually swims slowly through the water. I have suggested that these wing and tail surfaces act as stabilizers and also slow the bird down, both in horizontal but particularly vertical motion. A difficulty in submerged swimming, particularly at low rates of speed, is to overcome the tendency of buoyant objects to rise to the surface. Apparently the cormorant accomplishes this through vigorous paddling with its feet and dorsoventral steering with its tail, as well as through a degree of plumage wettability. I believe that the Anhinga accomplishes this through its lack of buoyancy, which is produced by the general lack of pneumaticity and through pronounced wettability of its plumage. Anhingas swimming at the surface with only neck and head emergent often advance in a series of curious bobbings. These may be produced by motion of the feet designed to move the bird upward to overcome the tendency of slow sinking.

The cormorant pursues its prey. It is also known to hunt the bottom for fish. Stomach contents of those collected in marine habitats confirm the latter type of hunting. In the Everglades, the cormorants pursue fish; whether or not they search the bottom for food here has not been established; in the Everglades, however, there is nothing comparable to the ocean floor communities of the nearby marine habitats.

The Skull.—The morphology of the skull of the Anhinga and the cormorant has been described by many investigators. The descriptions by Shufeldt (1902: 150–154, 165–169) contain the evident features and comparisons of skulls of the two genera. Discussion of the functional significance of these features has been largely neglected.

An occipital style (Figs. 45, 51) is apparently unique to cormorants and anhingas. In the cormorant, the style is robust, ossified, and has a movable articulation upon a prominent, rounded protuberance of the skull. Its shape is trihedral, a median crest passing along its dorsal surface. In the Anhinga the style is very small; it abuts the posteriorly-produced margin of the parietal; it is held in place by ligamentous material; it may be unossified; and it lacks ridges or protuberances.

TABLE 23
MEASUREMENTS OF THE SKULL AND JAW OF THE ANHINGA AND THE CORMORANT
(IN MILLIMETERS)¹

	Anhinga		Cormorant	
	Extremes	Mean	Extremes	Mean
Skull				
Length from tip of premaxilla to tip of exoccipital process	110.0-112.7	111.5	117.4-131.3	124.0
Length from tip of premaxilla to cranio-facial hinge	62.8- 64.8	64.0	62.2- 68.8	65.5
Greatest width through cranial bulge	22.3- 23.2	22.7	28.8- 31.5	30.1
Narrowest point through orbital area	6.4- 8.5	7.2	12.3- 16.4	14.5
Width through exoccipital processes	17.3- 18.5	18.0	28.2- 30.4	29.6
Height through widest point of rostrum	16.6- 17.8	17.3	24.3- 25.8	25.2
Jaw				
Length of ramus	102.1-111.3	106.9	109.6-125.8	117.8
Height through coronoid process	5.6- 8.3	5.8	10.0- 11.3	10.6

¹ Based on 2 males and 2 females of each species.

Four occipital styles of the cormorant averaged 26.3 millimeters in length; these displayed a range in length from 22.5 to 29.9 millimeters. At the articulating end these styles had an average width of 6.6 millimeters and an average height of 4.3 millimeters. Ten occipital styles of *Anhinga anhinga leucogaster* were dissected out. Two of these were not ossified, the entire mass being largely tendinous. [Verheyen (1953: 162-164) stated that *A. anhinga* is said to differ from *A. rufa* in the possession of an ossified rather than a fibrous style.] In *A. anhinga*, the style is surrounded by tough connective tissue. Superficial inspection of the Anhinga's style gives the impression of a much larger structure than can be separated from the investing tissues. These tissues probably serve to increase the area of muscle attachment. The eight ossified styles had an average length of 3.7 millimeters with extremes in length of 3.1 and 5.0 millimeters. They were either columnar or slightly wedge-shaped and had a dorsoventral thickness not exceeding one millimeter.

In general dimensions the cormorant skull is conspicuously larger than that of the Anhinga. Measurements of four specimens (two males, two females) of each species were made (Table 23). Greater individual variation in skull size is indicated in the cormorant, and its skull is wider and higher in relation to its length and in most features is more robust than is that of the Anhinga.

The upper mandible of the cormorant is hooked; in the Anhinga it is straight. Total length of the upper jaw represents a greater percentage of the total length of the skull in the Anhinga than it represents in the cormorant (Table 24). If the rhamphothecal length is considered, this contrast is increased. In the Anhingas dissected, the rhamphotheca extended beyond the bony tip of the mandible no less than 15 millimeters. In the cormorants examined, the thickness of the rhamphotheca on the distal half of the

TABLE 24
SKULL MEASUREMENTS EXPRESSED AS PERCENTAGES OF THE TOTAL LENGTH OF THE SKULL¹

	Anhinga		Cormorant	
	Extremes	Mean	Extremes	Mean
Length of upper mandible from tip of premaxilla to cranio-facial hinge	57.2-58.2	57.7	51.0-54.2	52.6
Width at widest point of cranial bulge	20.2-20.8	20.4	23.9-24.5	24.2
Width through exoccipital processes	15.5-16.4	16.1	22.9-25.5	24.1
Width at narrowest point through orbital area	5.6- 7.6	6.4	10.4-12.5	11.6
Greatest height through rostrum to top of skull	15.1-15.9	15.5	19.9-20.7	20.3
Length of lower jaw	91.0-99.1	97.0	92.5-95.9	94.9

¹ Based on 2 males and 2 females of each species.

mandible did not exceed three millimeters. The cranio-facial hinge (Fig. 51) is pronounced in the cormorant and, Pycraft (1898: 94) notwithstanding, in the Anhinga too; it is, however, somewhat differently developed in the two species.

The lower mandible differs markedly in the two birds. That of the cormorant is terminally decurved in opposition to the upper mandible; that of the Anhinga is acuminate. Total lengths of the mandibular rami form approximately the same percentage of the total lengths of the skull in both species (Table 24). In the Anhinga, however, the added length of the rhamphotheca contributes no less than an additional ten millimeters to the length of the lower jaw. The length of the gonys is considerably greater in the Anhinga. The lower mandible of the cormorant is more robust than that of the Anhinga. In the latter the height of the coronoid process is equal to 5.4 per cent of the length of the lower mandible; this ratio is nine per cent in the cormorant.

The posterodorsal and posterolateral surfaces of the skull are considerably different in the two species. In the cormorant, the crotaphyte (temporal) depression is wider and deeper than it is in the Anhinga (Fig. 47), and it is separated from that of the opposite side by a prominent occipital crest. From the squamosal process, an elevation passes dorsomesially to join the occipital crest (Figs. 51, 53); this elevation forms the posterior margin of the crotaphyte depression. In the Anhinga, the crotaphyte depression is shallow and neither it nor the weak elevation passing dorsomesially from the squamosal process reach the median line. The median portion of the dorsal surface of the skull is flattened, an occipital crest not being present. In the cormorant, the supraoccipital line lies ventral to the elevation extending dorsomesially from the squamosal process; in the Anhinga, the supraoccipital line is produced posteriorward and forms the posterodorsal margin of the skull.

There are relative differences in the widths of the posterior-facing and posteroventral surfaces of the skull. In the cormorant, the distance between the lateral margins of the apices of the exoccipital processes is equal to 98.3

per cent of the greatest width of the skull; in the Anhinga this distance is equal to only 79.3 per cent of the skull width. The supraoccipital is more ventrally situated in the cormorant, and it is not as wide dorsoventrally as in the Anhinga. The exoccipital area in the cormorant is more extensive.

The pterygoid is trihedral in the cormorant; in the Anhinga, it is flattened. The quadrate is smaller and less robust in the Anhinga (Fig. 46). In the cormorant, lateral and mesial heads of this bone are both well-developed, whereas in the Anhinga the lateral head is comparatively small.

In the cormorant, greater and more effective areas of origin are afforded mandibular adductors by the crotaphyte depression, the occipital style, the occipital crest, and the elevated ridge extending dorsomesially from the squamosal process.

Two conspicuous differences in the skulls involve the foramen magnum and the orbits. The supraoccipital area in the Anhinga projects caudad of the foramen magnum as well as somewhat ventrad of the dorsal margin of the foramen; in dorsal view of the Anhinga's skull, one can see neither the foramen magnum nor the occipital condyle, both of which are apparent in dorsal view of the cormorant's skull. Inspection of the eyes of fresh specimens and of the orbits of the skull show that the eyes lie much closer together in the Anhinga. The area within which binocular vision may be possible would seem to be considerably different in the two species.

The head of the Anhinga is adapted for impaling prey. The mandibles are long and thin; their effective length is considerably increased by a thick, light rhamphotheca and strength is gained by a longer gonys. The mandibular musculature is reduced, and the skull is small and light.

In the cormorant, the greater width between the exoccipital processes and the greater width of the basitemporal plate increase, comparatively, the effectiveness of depressors and rotators of the head, which insert upon these areas. The positions of the supraoccipital bone and supraoccipital line in the Anhinga increase the effectiveness of the extensors of the head in this species.

Certain Muscles of the Skull and Jaws.—The muscle descriptions and volumetric determinations are based upon four specimens (two males, two females) each of the Anhinga and the cormorant.

Fisher and Goodman (1955: 16) observed that it is virtually impossible to assign names to avian head muscles, particularly the adductors, that are in any sense definitive, the terminology being one characterized by confusion. With the head muscles, this investigation is concerned primarily with pointing out differences between the two species and with attaching significance to these differences. In no sense is this treatment of the myology intended to be definitive.

The terminology of the muscles of the anterior portion of the neck, which attach to the skull, has been selected from Boas (1929), Fisher and Goodman (1955), and other authorities as noted. For muscles important in jaw action, Hofer (1950) and certain other investigators, as indicated, have been followed in the nomenclature.

A DERMAL MUSCLE OF THE DORSAL SURFACE OF THE SKULL

General.—This muscle (Fig. 47) does not agree with descriptions of similar dermal muscles of other species. *M. dermatemporalis*, for example, is described by Fisher and Goodman (1955: 9) as originating from the opisthotic process in the Whooping Crane,

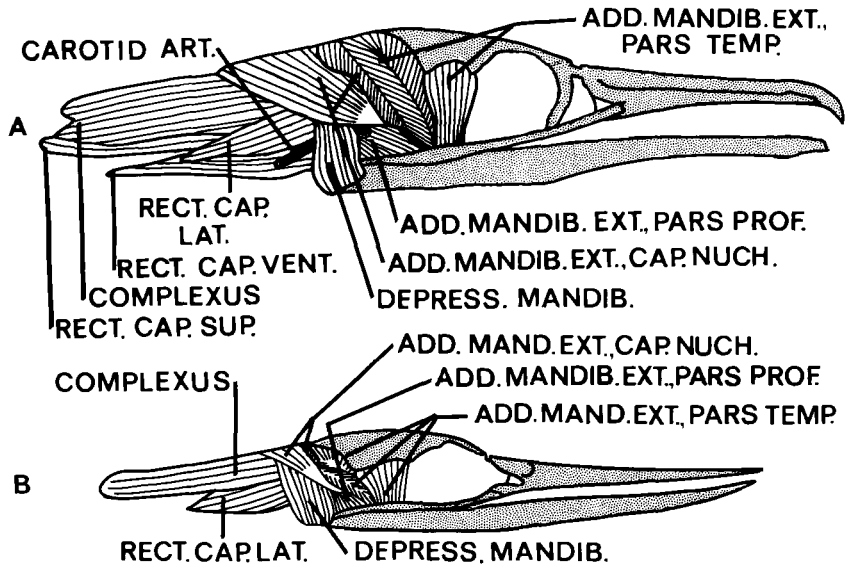

Figure 44. Lateral view of the superficial layer of muscles of the skull of the cormorant (A) and the Anhinga (B).

Grus americana (Linnaeus), and by Shufeldt (1890: 5) as originating from a small depression anterior to the temporal fossa in the Raven, *Corvus corax sinuatus* Wagler.

Origin.—Largely aponeurotic from the mesial half or so of the anterior margin of the crotaphyte depression (Figs. 49–51); the origin may continue posteriorly along the mesial margin of the depression.

Insertion.—Largely fleshy upon the dermis of the posterior portion of the head and anterior part of the neck.

Action.—Assists in positioning of the feathers of the sides and crown of the head and of the extreme anterior portion of the neck.

Comparison.—The belly is smaller but fleshier in the Anhinga; it is largely aponeurotic in the cormorant.

M. COMPLEXUS

General.—Equals *M. cucullaris, caput portion* of some workers (Fisher and Goodman, 1955). *M. complexus* (see Boas, 1929) is a superficial muscle upon the dorsal and dorso-lateral surfaces of the neck (Figs. 44, 45, 47). Its lateral margin is attached by fascia and fleshy fibers to a portion of the belly of *M. rectus capitis lateralis*, which lies deep to it.

Origin.—Mixed, from the lateral surfaces of the prezygapophyses of cervical vertebra III and from a ridge along the lateral surface of the centrum of this vertebra; largely tendinous from the postzygapophyses of cervical vertebra III and the prezygapophyses of vertebra IV; weak tendinous origin may arise from the postzygapophyses of vertebra II (Figs. 49–51).

Insertion.—Aponeurotic upon the supraoccipital line (Figs. 51, 53). The insertion is continuous laterally with that of *M. rectus capitis lateralis*; the entire insertion lies deep to the posterior division of *M. adductor mandibulae externus, caput nuchale*.

Action.—Extends the head; unilateral action raises and turns the head towards one side.

Comparison.—In the Anhinga, the volume of this muscle is considerably larger than in the cormorant (Table 25). The supraoccipital line, upon which the muscle inserts, is in a more dorsal position in the Anhinga and fusion of the muscle with the belly of *M. rectus capitis lateralis* is not as extensive as in the cormorant. The origin extends as far posteriorly as cervical vertebra number V in the cormorant, but only on to number IV in the Anhinga. In both species, that portion of the muscle lying deep to *caput nuchale* of the

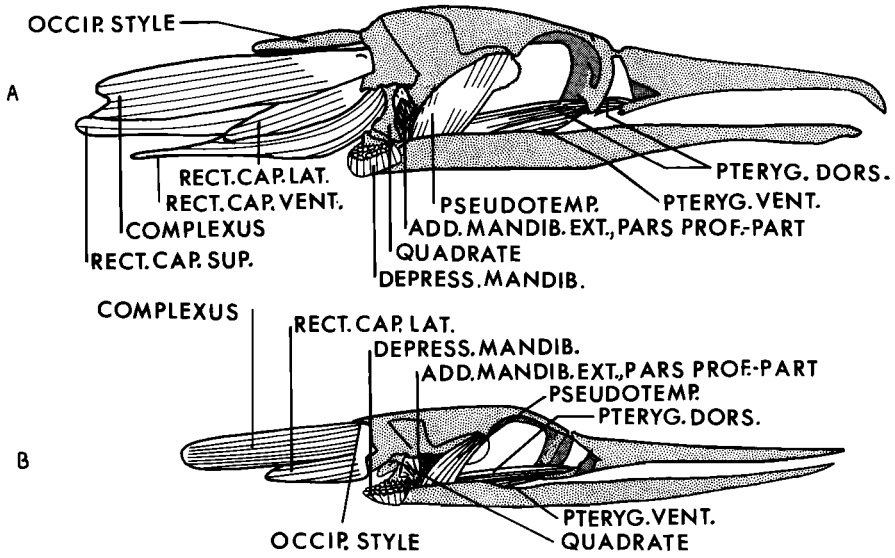

Figure 45. Lateral view of a second layer of muscles of the skull of the cormorant (A) and the Anhinga (B).

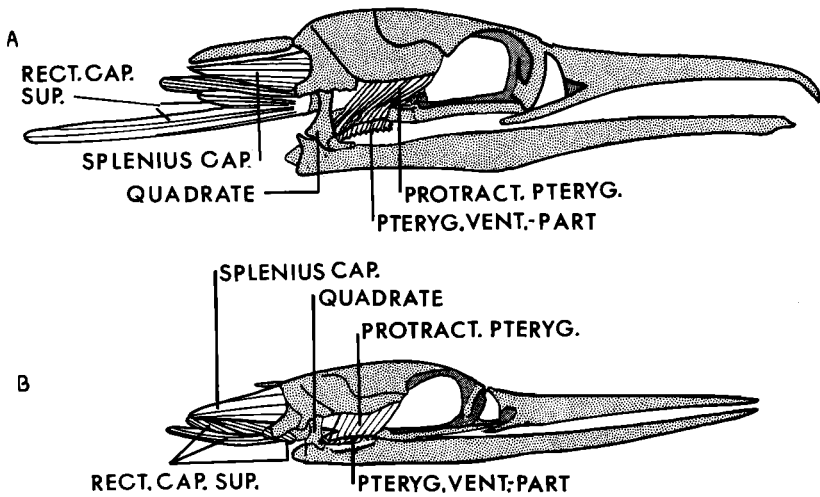

Figure 46. Lateral view of a third layer of some muscles of the skull of the cormorant (A) and the Anhinga (B).

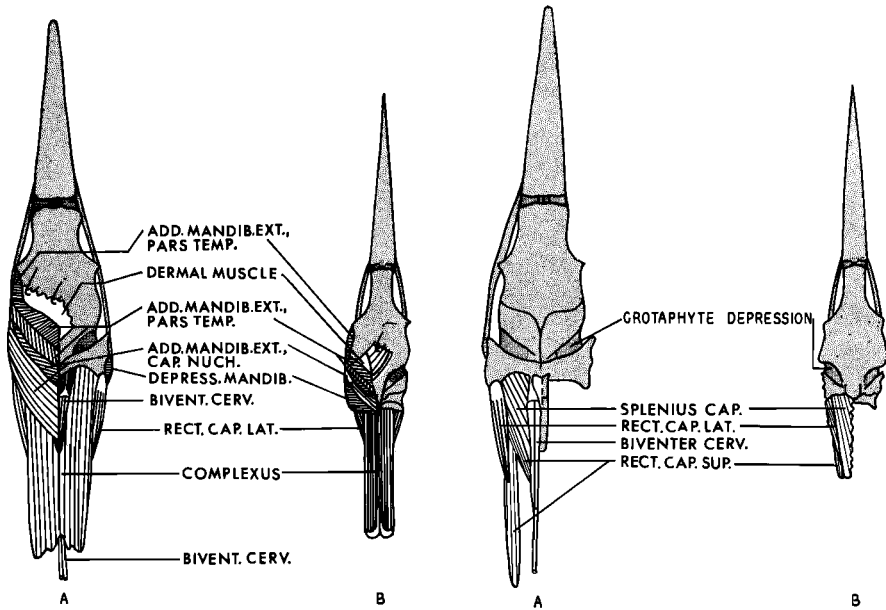

Figure 47. Muscles of the head of the cormorant (A) and the Anhinga (B) in dorsal view. The two left figures show the superficial layer on the left side of the head and a second layer on the right side of the head. The two right figures show a third layer on the left side of the head.

mandibular adductor is largely aponeurotic; however, *caput nuchale* extends farther caudad in the cormorant. The insertion continues to a point immediately lateral to the median point of the skull in the Anhinga, whereas in the cormorant, the insertion lies lateral to the articulation of the occipital style and the insertion of *M. depressor mandibulae*.

Discussion.—See *M. splenius capitis*.

M. BIVENTER CERVICIS

General.—This muscle is not present in the Anhinga. It is very small in the cormorant (Fig. 47). The fine tendons of origin of the paired muscles pass forward along the dorsomedial surface of the neck. The short bellies form deep to the caudal border of *M. complexus*.

Origin.—The dorsomesial surfaces of *M. spinalis cervicis*.

Insertion.—By a short tendon, which attaches to the mesial end of the supraoccipital line (Fig. 54).

Action.—*M. spinalis cervicis* inserts upon the anterior cervical vertebrae. Its action elevates the latter and draws them posteriorly, thus bringing *M. biventer cervicis* to effect similar action upon the skull.

Discussion.—*Mm. complexus* and *splenius capitis*, which are comparatively larger in the Anhinga, probably compensate for any comparative loss of function which might result from the lack of *M. biventer cervicis* in this species.

M. SPLENIUS CAPITIS

General.—This is a stout muscle, which lies deep to *M. complexus* (Figs. 46, 47). The proximal portion is superficial to *M. rectus capitis superior*, and the distolateral portion has extensive fascial connections with *M. rectus capitis lateralis*.

Origin.—Mixed, from the dorsomesial surface of the posterior zygapophyses and the length of the neural crest of the axis (Figs. 49–51), and from the fascia passing from the dorsal surface of the axis to the skull.

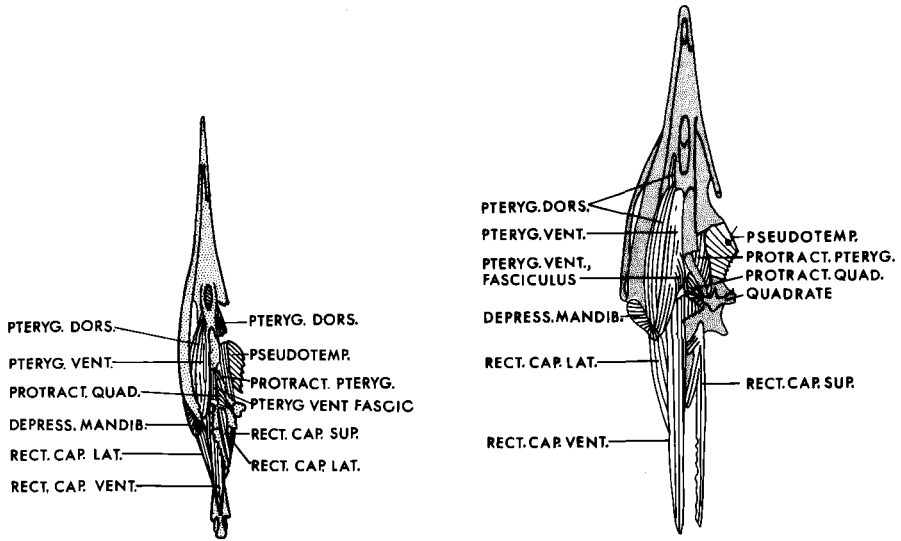

Figure 48. Muscles of the head of the Anhinga (*left*) and the cormorant (*right*) in ventral view. The superficial layer is shown on the left side of each figure and a second layer on the right.

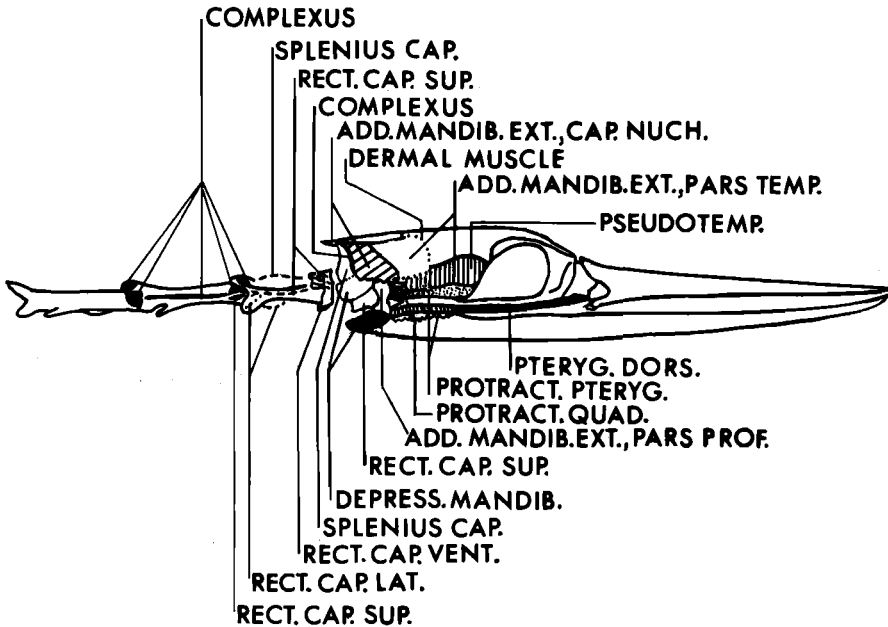

Figure 49. Lateral view of origins and insertions of muscles of the skull of the Anhinga.

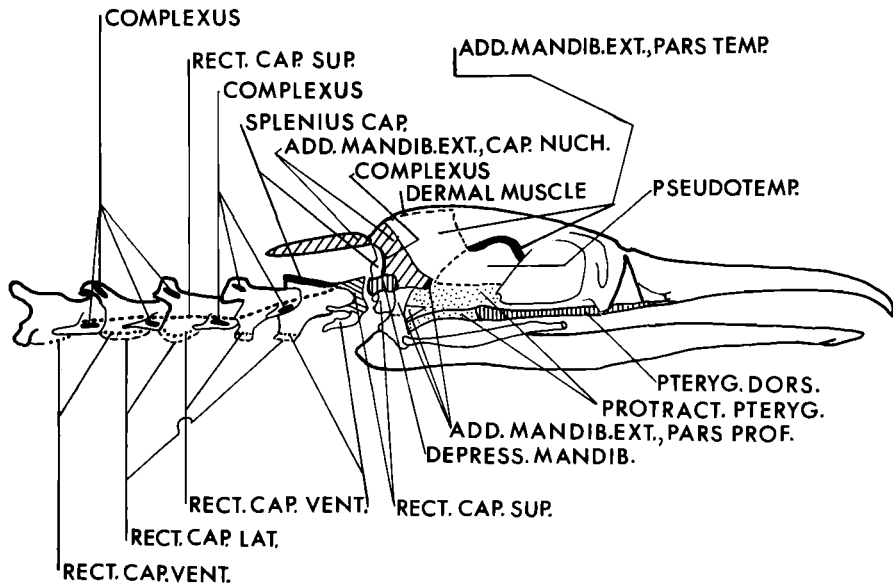

Figure 50. Lateral view of origins and insertions of muscles of the skull of the cormorant.

Insertion.—Largely fleshy upon the supra- and exoccipital regions (Figs. 49–51, 53).

Action.—Extension of the skull; unilateral action rotates the skull.

Comparison.—Volume of this muscle in the Anhinga constitutes almost twice the percentage of the total volume of the skull muscles than it does in the cormorant (Table 25). There are considerable differences in the areas of insertion. In the Anhinga, the supra-occipital area is comparatively larger and occupies a more dorsal position upon the skull, and the exoccipital area is not as extensive and does not extend as far laterally as in the cormorant. Connections between the bellies of either side of the muscle are more extensive in the Anhinga, and the origin is from the fascia passing from the atlas to the skull rather than from the atlas itself as in the cormorant.

Discussion.—This is the important extensor of the head. It is augmented in its action to some extent by *M. complexus* and to a very slight extent by *M. rectus capitis lateralis*. With *M. complexus*, it constitutes more than 50 per cent of the total volume of the neck muscles attaching to the skull of the Anhinga and approximately 35 per cent of this value in the cormorant.

In the Anhinga, the force necessary to lift the head with a fish impaled upon the distal end of the mandibles and to flip the fish free of the mandibles is probably greater than that required to lift the head of the cormorant when it is carrying a fish which is held more proximally in its mouth, greater leverage of mandibular force then being possible. When surfaced, the Anhinga carries a fish upon its mandibles, which are pointed upwards; force required to hold the mandibles in this position is probably considerably less than with them in a more horizontal position.

The areas of insertion of this muscle indicate that it is more effective as an extensor in the Anhinga than in the cormorant and that in the latter it may have greater effectiveness in moving the head from side to side than in the Anhinga.

M. DEPRESSOR MANDIBULAE

General.—This large superficial muscle passes from the posterolateral surface of the skull to the mandible (Figs. 44, 45, 47, 48). Tough fascia connects the belly intimately with contiguous portions of *M. adductor mandibulae externus*. The belly is separable into lateral and deep portions, separate origins and insertions being more or less discernible

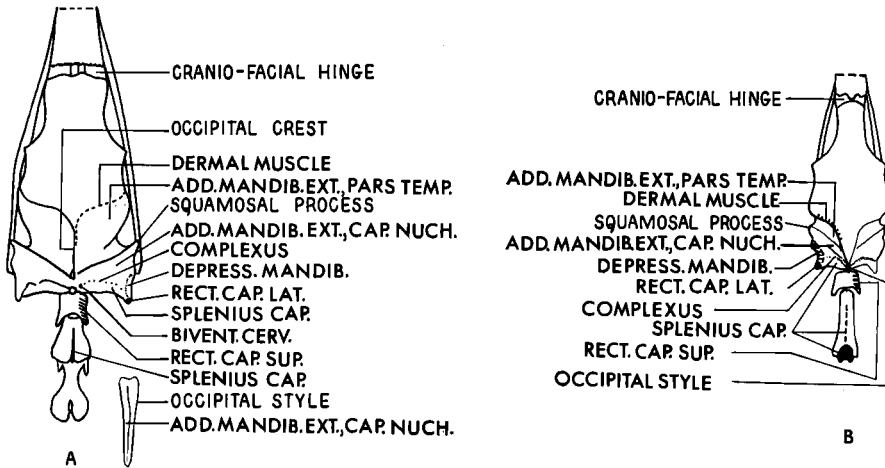

Figure 51. Dorsal view of origins and insertions of the muscles of the skull of the cormorant (A) and the Anhinga (B).

for each. The lateral belly encircles the deep belly posteriorly, and the muscle fibers in this region are more concentrated as they pass to the insertion.

Origin.—The lateral belly has intimate connections with the lateral surface of *M. adductor mandibulae externus, caput nuchale* and originates, in part, from the aponeuroses of insertion of *M. complexus* and *M. rectus capitis lateralis*. In two specimens, tendinous origins were also taken from the supraoccipital line contiguous to the insertion of *M. complexus*. The fleshy origin is from the lateral surface of the length of the exoccipital process. The deep belly originates from the ventral edge of the exoccipital process. See Figures 49, 50, 52, 53.

Insertion.—Largely fleshy. The lateral belly inserts upon the lateral and posterior surfaces of the external articular process, the deep layer upon the internal articular process. See Figure 54.

Action.—Abduction of the lower jaw.

Comparison.—There are considerable differences in the muscle in the two species. In the cormorant, attachments to *M. adductor mandibulae externus, caput nuchale* are not well developed and while origin is taken from the surface of *M. complexus*, this is neither as intimate nor as extensive as in the Anhinga, nor is the origin from the inserting aponeurosis of *M. complexus* as well developed in the cormorant as in the Anhinga. No origin from the supraoccipital line was found in any of the cormorants dissected. A separation of the muscle into lateral and deep bellies was not apparent in the cormorant. In the Anhinga, the volume of this muscle constitutes more than twice the percentage of the total volume of the jaw muscles than it does in the cormorant (Table 26).

Discussion.—See page 126.

M. RECTUS CAPITIS LATERALIS

General.—This superficial muscle passes from the anterolateral portion of the neck to the skull (Figs. 44, 45, 47). Fisher and Goodman (1955: 13) noted connections of the muscle with contiguous muscles of the Whooping Crane; in both the Anhinga and the cormorant, there are fascial and fleshy connections with the bellies of *Mm. complexus, flexor capitis ventralis*, and *splenius major*.

Origin.—Tendinous from the parapophysial spines of the axis, weakly tendinous from the haemal crest of the latter as well as from the ventral surface of the posterior zygophyses of cervical vertebra III. See Figures 49, 50, 52.

Insertion.—Tendinous upon the apex, distomesial, and dorsolateral edges of the exoccipital process (Figs. 51–53). Insertion may extend mesially toward the paraoccipital process.

Action.—Contraction of the belly of one side would rotate the head; extension of the

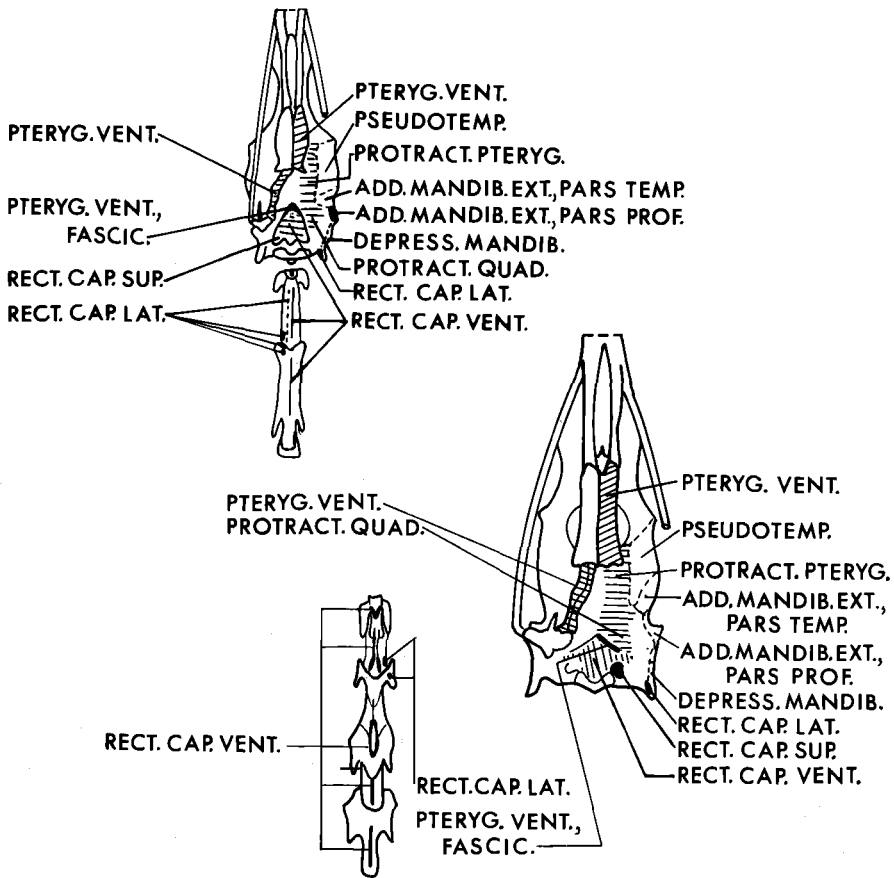

Figure 52. Ventral view of origins and insertions of muscles attaching to the skull of the Anhinga (*above*) and the cormorant.

head would be facilitated by simultaneous contraction of bellies of both sides.

Comparison.—The ratio of the muscle's volume to the total weight of the bird is much greater in the cormorant, and in this species, origin is also taken from the hypophyses of cervical vertebrae III and IV, and connections of the muscle with contiguous ones are somewhat less extensive than in the Anhinga. It should be noted that the exoccipital processes are relatively farther apart in the cormorant.

Discussion.—In the Anhinga, the more extensive connections of this muscle with certain contiguous ones probably facilitate a more uniformly distributed force in maintaining the position of the head during the impact of impaling fish and may provide for more effective support of the weight of the prey upon the mandibles, as well as elevation of the head, prior to flipping the fish from the mandibles. In the cormorant, the greater bulk of this muscle, its wider points of insertion, and its action, which is apparently more independent of contiguous muscles, suggest that the muscle is more effective in posturing the head and in moving it laterally.

M. RECTUS CAPITIS SUPERIOR

General.—This is a deep muscle passing from the lateral surface of anterior cervical vertebrae to the skull (Figs. 44-48). Three fasciculi of origin are evident, but there

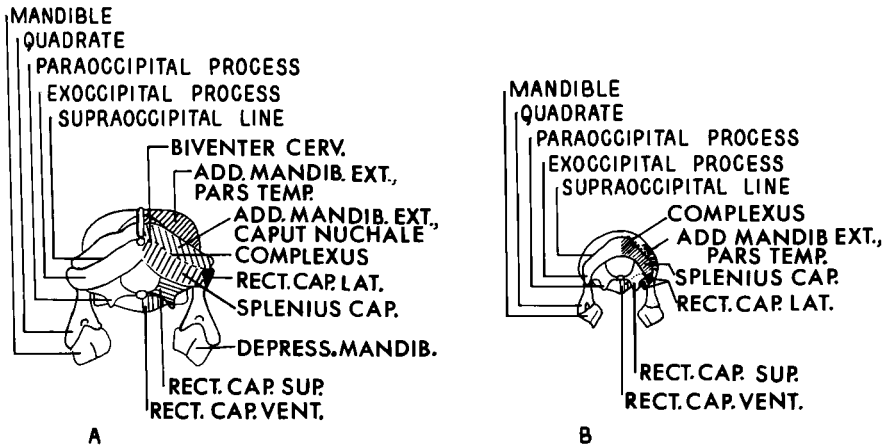

Figure 53. The posterior surfaces of the skull of the cormorant (A) and the Anhinga (B) showing origins and insertions of muscles.

is a common insertion. Much of the muscle lies deep to *M. rectus capitis lateralis*.

Origin.—Anterior fasciculus: fleshy from the lateral surface of the centrum and from lateral and ventral surfaces of the postzygapophysial process of the atlas. *Central fasciculus:* largely fleshy from the anterolateral face of the postzygapophysis and from an elevated ridge upon the lateral surface of the axis. *Caudal fasciculus:* mixed, from the lateral surface of the prezygapophyses and from the ventrolateral surface of the centrum of cervical vertebra III. The origins are shown in Figures 49–51.

Insertion.—Largely fleshy upon the paraoccipital processes, and anterior to this, upon a small portion of the basitemporal plate (Figs. 49–53).

Action.—Unilateral contraction of the bellies would depress the head toward the side of contraction; simultaneous action of both bellies would flex the head.

Comparison.—This muscle comprises a significantly greater percentage of the volume of the neck muscles attaching to the skull of the cormorant (Table 25). When expressed as per cent of body weight, its relatively greater volume in the cormorant becomes conspicuous (Fig. 55). In the cormorant, an origin not found in the Anhinga, is from cervical vertebrae IV, V, and VI.

Discussion.—Like the other anterior neck muscles attaching to the skull, this is far better developed in the cormorant. Its development must obviously be correlated with the far

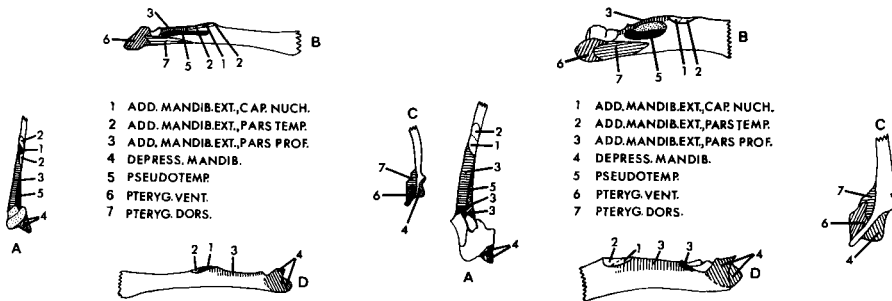

Figure 54. Attachments of muscles upon the ventral (A), mesial (B), lateral (C), and dorsal (D) surfaces of the lower jaw of the Anhinga (four left figures) and the cormorant.

greater degree of head mobility, probably related to the grasping of elusive prey. Its action also may be of importance during securing of bottom-dwelling organisms, which the cormorant may seek to some extent when in a marine environment.

M. RECTUS CAPITIS VENTRALIS

General.—This is ventromedian, superficial muscle (Figs. 44, 45, 48). The bellies of the opposite sides are closely connected by fascia, fleshy fusion of them being made immediately proximal to insertion. The lateral portion of the anterior third, or so, of the belly lies superficial to part of *M. restus capitis superior*.

Origin.—Mixed, from the cranial two-thirds of the hypophyseal line upon cervical vertebra III, from the length of the hypapophysis of the axis, and from the lateral surface of the apex of the hypapophysis of the atlas (Figs. 49, 50, 52).

Insertion.—Largely fleshy upon the basitemporal plate (Figs. 52, 53).

Action.—Flexion of the head; unilateral contraction of the bellies depresses the head toward one side and may rotate it slightly.

Comparison.—This constitutes a considerably larger volume of the non-jaw muscles attaching to the skull in the cormorant than in the Anhinga. It may be noted that the area of insertion, the basitemporal plate, is somewhat wider in the cormorant, and in this species, the muscle also originates from cervical vertebrae IV, V, and VI, which is not the case in the Anhinga. The fusion of the bellies of opposite sides is not as extensive in the Anhinga.

Discussion.—The force of the muscle appears to be applied to the head through a greater arc in the cormorant; the independent, as well as the synergistic, action of the muscle is no doubt of the same importance as that described for *M. rectus capitis lateralis*.

M. ADDUCTOR MANDIBULAE EXTERNUS, CAPUT NUCHALE

General.—Hofer (1950: 444) referred to that portion of *M. adductor mandibulae externus* which arises from the area about the occipital style as the "caput nuchale." Fibers of the muscle are directed anteroventrally toward the lower jaw (Figs. 44, 47). There are apparently two portions of the muscle.

Origin.—The posterior portion of the muscle arises from the occipital style and from the raphe-like material surrounding it. A smaller anterior portion has a fleshy origin from the area of the skull bounded by the supraoccipital line and the elevation passing dorsomesially from the squamosal process. See Figures 49, 50, 51, 53.

Insertion.—That portion of the muscle originating from the occipital style forms a stout tendon which lies deep, distally, to suprafacial fibers of *M. adductor mandibulae externus, pars profundus* and, surrounded by fibers of the latter, inserts upon the posterior half of the coronoid elevation. A portion of the insertion lies lateral to that of *M. adductor mandibulae externus, pars temporalis*, as well as contiguous to the posterior and lateral surfaces of this muscle's insertion. The anterior portion inserts fleshily upon the tendon of the portion of the muscle originating from the occipital style. See Figure 54.

Action.—Contributes to adduction of the jaw.

Comparison and Discussion.—See pages 123–125.

M. ADDUCTOR MANDIBULAE EXTERNUS, PARS TEMPORALIS

General.—If I have interpreted Hofer's (1950: 444) description of this muscle correctly, it consists of: a wide, thin anterior portion just posterior to the orbit and posterior portions, pennate in structure, which arise from the crotaphyte depression.

Origin.—Fleshy. The anterior portion arises from the ridge which extends from the postorbital process to the crotaphyte depression. The posterior portions arise from the latter depression, the most superficial of these, however, also arises from the apex of the squamosal process. See Figures 49–51.

Insertion.—The anterior part has a fleshy insertion upon the anterior end of the coronoid elevation. The posterior portions have largely tendinous insertions upon the central portion as well as the mesial border of the coronoid elevation. See Figure 54.

Action.—Contributes to the adduction of the lower jaw.

Comparison and Discussion.—See pages 123–125.

M. ADDUCTOR MANDIBULAE EXTERNUS, PARS PROFUNDUS

General.—So designated by Hofer (1950: 444), this muscle is in superficial view immediately anterior to *M. depressor mandibulae* (Fig. 44). The muscle makes a fleshy attachment to the tendon of *M. adductor mandibulae externus, caput nuchale*, which passes

deep to it. A deep portion of the belly is more or less separable from the superficial portion and may represent *M. adductor mandibulae medius*. Its volume is included with that of *M. adductor mandibulae superficialis*. The muscle is not figured.

Origin.—Fleshy from the whole lateral surface and anterodorsal surface of the quadrate. Fleishy and tendinous from the overhanging squamosal. The deep portion originates from the anterior face of the quadrate, as well as from the lateral and anterior surfaces of the orbital process (Figs. 49, 50). The muscle's close connections with other portions of *M. adductor mandibulae externus* imply additional functional, though indirect, origins.

Insertion.—Largely fleshy, in part tendinous, upon that portion of the dorsal crest of the mandible lying between the coronoid elevation and the articulation of the quadrate (Fig. 54).

Action.—Contributes to adduction of the jaw.

Comparison.—The origins of this muscle in the cormorant are less fleshy than in the Anhinga and arise from a more restricted area of both the quadrate and squamosal process. The origin from the lateral surface of the orbital process was variable and not pronounced in the cormorants dissected (Fig. 45).

Discussion.—See pages 123–125.

M. PSEUDOTEMPORALIS

General.—This large muscle, figured by Hofer (1950: 470) for *P. carbo*, lies deep to portions of *M. adductor mandibulae externus*, *pars temporalis* (Figs. 45, 48). Its fibers are directed posteroventrally at an angle of approximately 45 degrees.

Origin.—Fleshy from the side of the cranial bulge, extending posteriorly from the post-orbital process (Figs. 49, 50); there is some attachment to orbital fascia (Fig. 45).

Insertion.—Fleshy within the whole of the fossa upon the mesial surface of the posterior half of the lower jaw, extending considerably anterior to the fossa in the Anhinga (Fig. 54).

Action.—Powerful adduction of the lower jaw; its action also draws the lower jaw forward and may also draw the thin flexible rami of the Anhinga from a widely spread position to a more mesial one, thus narrowing the gular cavity and possibly imparting a forward thrust to the apex of the lower jaw.

Comparison and Discussion.—See page 124.

MM. PTERYGOIDEUS VENTRALIS and PTERYGOIDEUS DORSALIS

General.—In many birds, these two muscles both have subdivisions, often complex, which are regarded as having considerable comparative significance (Lakjer, 1926: 25; and Hofer, 1950: 481–482). In the Anhinga and the cormorant, the origins of these two muscles are discrete, but the bellies become intimately connected (Figs. 45, 48) and the insertions are contiguous. Subdivisions of the bellies of the two muscles are not readily apparent. A small fasciculus of the ventral portion of the muscle passes from the posterior border of the palatine to an aponeurosis, which attaches to the anterior margin of the basitemporal (Figs. 48, 52).

Origins.—*M. pterygoideus ventralis* arises fleshy from the entire ventral surface of the palatine and the pterygoid. A stout tendinous sheath, which is applied to the mesial surface of the belly, arises from the longitudinal crest at the juncture of the two palatines and variably from the pterygoid. There is mixed attachment to the lateral edge and crest of the palatine. See Figure 52.

M. pterygoideus dorsalis arises fleshy from the whole of the dorsal surface of the palatine bone and from the dorsal surface of the palatal process of the premaxilla, this continuing anteriorly, with some variation, to the anterior end of the nasal cavity (Figs. 49, 50).

Insertions.—The belly of the dorsal muscle passes laterally around the palatine and merges along much of its length, as well as at the posterior end of the palatine, with that of the ventral belly. A fascial separation is more or less evident between the two bellies, particularly a short distance proximal to insertion. The ventral division inserts largely upon the distodorsal surface of the postarticular process; the dorsal division, the insertion of which is contiguous with the former, is upon the remaining portion of the postarticular process and the mesial surface of the lower jaw (Fig. 54). From *M. pterygoideus ventralis* stout fascial connections pass to the anterior end of the basitemporal plate, to which there may also be a variably weak fleshy connection.

Action.—Depression of the upper mandible.

Comparison.—In *P. auritus*, the fasciculus to the basitemporal arises in large part from the mesial surface of the belly of *M. pterygoideus ventralis*, much as Dullemeijer (1951: 258) described it for *P. carbo*. In the Anhinga, the fasciculus was found to arise from the

posterior portion of the palatine, no connections with the belly of *M. pterygoideus ventralis* being found. While origin of the fasciculus may, in some part, be from the palatine in the cormorant, the difference between the two species is noteworthy. Volumetric comparison of the fasciculi in the two species was not possible; the fasciculus appears to be somewhat larger in the Anhinga.

Discussion.—See pages 126–127.

M. PROTRACTOR PTERYGOIDEUS

General.—This is a deep muscle of the lateral surface of the skull. *M. pseudotemporalis* lies superficial to it (Figs. 46, 48). Its caudal margin is contiguous with, but more or less separable from, the belly of *M. protractor quadratus*.

Origin.—From a slight elevation on the ventral surface of the cranial bulge, as well as mesial to this; the attachment extends caudad from a point ventral to the postorbital process. See Figure 52.

Insertion.—Fleshy upon the dorsal and lateral surfaces of the pterygoid, extending caudad to cover the pterygoid-quadratus articulation (Figs. 50, 51).

Action.—Draws the pterygoid anteriorly, thus elevating the upper mandible.

Comparison and Discussion.—See page 126.

M. PROTRACTOR QUADRATUS

General.—The anterior end of this small muscle is contiguous with the belly of the preceding muscle (Fig. 48). It passes mesially and anteromesially to its insertion.

Origin.—The cranium immediately posterior to the origin of *M. protractor pterygoideus* (Fig. 52).

Insertion.—Largely fleshy from the ventromesial surface of the quadrate.

Action.—Draws the quadrate anteriorly as well as mesially, thus contributing to abduction of the upper mandible.

Comparison and Discussion.—See page 126.

DISCUSSION

Comparison of the skulls and of the neck muscles attaching to them and an examination of the comparative development of the muscles of the jaws of the Anhinga and cormorant emphasize how differently these two species are adapted to secure their food.

A streamlined head has been correlated with submerged pursuit of fish in mergansers (Dullemeijer, 1951: 247), and in *Phalacrocorax carbo* (Goodman and Fisher, 1962). While the Anhinga does not as actively pursue fish as the aforementioned birds, the sudden thrust of its head by which it impales them is obviously facilitated by the least possible resistance to water, and in this fish-eater, streamlining of the skull has reached an extreme. Both the skull and the muscles of the anterior portion of the neck which attach to it are much reduced and modified in the Anhinga. Its jaws, though comparable in length with those of the cormorant, have a quite differently-proportioned musculature.

The muscles of the neck attaching to the skull.—The considerable mobility of the head required both in anticipating and in grasping prey, as well as the force needed in supporting the weight of large fish held between the mandibles of a long, straight skull at a point far anterior to the articulation of the skull with the cervical vertebrae, are reflected by the values obtained in comparing volumes of the anterior muscles of the neck with the cube root of body weight (Fig. 55). These values show that in the case of each of these muscles a relatively smaller volume is found in the Anhinga. There are, however, different degrees of difference in the values. In considering the functional significances of the individual muscles, their volumes ex-

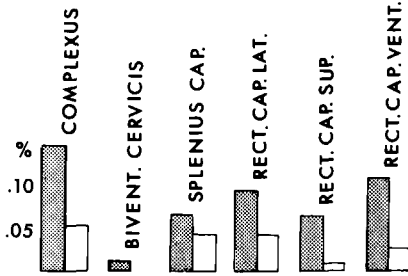

Figure 55. Volumes of the neck muscles attaching to the skull expressed as percent of body weight in four specimens (two males and two females) of the Anhinga and the cormorant. Values for the cormorant are shaded.

pressed as percentages of the total volume of the anterior neck muscles (Table 25) and the osteological characteristics are of interest.

That there is more effective horizontal and rotational head movement in the cormorant seems evident from its wider skull and thus more widely spaced areas of insertions for muscles effective in such movement. These actions are effected by a number of muscles in varying degree, *Mm. rectus capitis lateralis*, *complexus*, *splenius capitis*, and *rectus capitis superior* among them. Synergistic actions of these muscles and their importance in other movements of the head, however, make comparison of them with respect to horizontal and rotational movements of the head without any clear significance. The more widely spaced areas of insertion of these muscles in the cormorant, however, particularly those of *M. rectus capitis lateralis*, are noteworthy.

Flexion of the head is brought about largely by *M. rectus capitis ventralis* and, to a lesser extent, by *M. rectus capitis superior*. The significantly greater percentage of the total volume of the anterior neck muscles that these form in the cormorant (Table 25), in particular in the case of the former, certainly points to a greater potential for flexion in this species.

The main extensors of the head, *Mm. splenius capitis* and *complexus* together represent more than 52 per cent of the total volume of the neck muscles attaching to the skull of the Anhinga and only about 35 per cent of this in the cormorant. (The volume of *M. biventer cervicis*, a muscle not present in the Anhinga, increases the percentage of the total volume of the head extensors to about 40 per cent in the cormorant.) The areas of insertion of the extensors are more medial and dorsal in the Anhinga, powerful action with but slight horizontal components being indicated. The significance of this would seem correlated with action necessary to prevent struggling fish from slipping from the mandibles, holding the head slightly aloft being more effective than holding it horizontally or at angles less than the horizontal. The weight of an impaled fish is probably held with greater ease when the head is slightly elevated, the neck then being more nearly under the head. There seems little necessity for horizontal motion of the head when striking fish or when holding the pierced prey. I have often observed that a cormorant, while gaining control over fish seized between its mandibles, engages in vigorous horizontal motions of

TABLE 25
 VOLUMES OF MUSCLES PASSING BETWEEN THE NECK AND SKULL OF THE ANHINGA AND THE
 CORMORANT, EXPRESSED AS PERCENTAGES OF THE TOTAL VOLUME OF THESE MUSCLES¹

	Anhinga		Cormorant	
	Extremes	Mean	Extremes	Mean
complexus	25.17-31.97	27.45	22.34-24.22	22.79
biventer cervicis	absent		2.82- 4.44	3.50
splenius capitis	21.31-26.53	24.76	12.20-16.43	13.58
rectus capitis lateralis	16.44-21.11	19.31	18.16-22.79	19.54
rectus capitis superior	8.88-12.77	11.26	13.32-15.80	14.69
rectus capitis ventralis	12.22-18.66	15.69	23.62-27.47	25.30

¹ Based on 2 males and 2 females of each species.

the head. Anhingas observed surfacing with fish invariably have their heads held well above the horizontal; they hold the head thusly to disengage the fish, and the head is usually held high as the fish is worked backward within the mouth for swallowing.

The power for the sudden forward thrust of the head by the Anhinga is, of course, furnished by the posterior muscles of the neck. Modifications of the anterior neck muscles which may be correlated with the forward thrust of the head are not obvious. The greater development of the extensors might indicate importance of such an attitude of the head at the instant of impaling, as well as afterward. The greater degree of strong fascial connections between the anterior neck muscles in the Anhinga may contribute to a more uniform force of resistance to change in the head's position, this being important at the impact of the mandibles with the fish.

Jaw Action.—The pronounced differences in the utilization of the jaws in securing prey and the obvious quantitative differences in the jaw musculature of Anhingas and cormorants make convenient a comparison of the myology according to the different categories of obvious jaw action. Possible correlations of myology with function are discussed here, rather than as in preceding sections along with the descriptive treatment accorded the individual muscles.

Adduction of the lower jaw.—The muscles of adduction are developed to a conspicuously different degree in the two species. Far more extensive cranial surfaces and a much more pronounced crotaphyte depression in the cormorant afford areas of origin from which arise a significantly larger *M. adductor mandibulae externus*. The long-headed appearance of the cormorant as well as the greater dorsoventral thickness of the most anterior portion of the neck are the result, in large part, of the great bulk of *caput nuchale* of *M. adductor mandibulae externus*, the main portion of the origin of this arising from the occipital style which, overlying the anterior muscles of the neck, protrudes well caudad of the skull itself.

The great reduction in the bulk of the jaw musculature of the Anhinga, correlated with its entirely different method of securing prey, in my opinion, renders the values obtained by expressing the volumes of these muscles as a proportion of body weight of somewhat less significance than myological comparisons where function differs largely in degree. A comparison of the

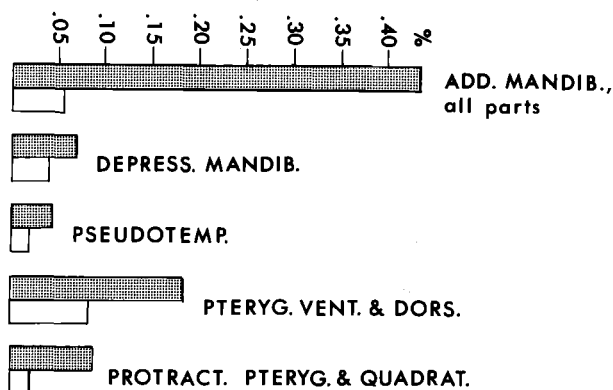

Figure 56. Volumes of the muscles of the jaws expressed as percent of body weight in four specimens (two males and two females) of the Anhinga and the cormorant. Values for the cormorant are shaded.

percentages of the total volume of the jaw musculature which each muscle represents affords in this case an indication of the importance of individual muscle action, which may be of somewhat greater use in analyzing the components of jaw action than in the analyses of other muscle systems of the two species. With respect to the combined portions of *M. adductor mandibulae externus*, both sets of values point to a great reduction in volume of this muscle in the Anhinga. Expressed as per cent of body weight, the muscle is approximately eight times larger in the cormorant (Fig. 56), as a percentage of the total volume of the jaw muscles (Table 26) slightly less than two times larger in this species. *M. pseudotemporalis*, likewise an important adductor, is two and one-half times larger in the cormorant when expressed as per cent of body weight (Fig. 56), but it forms a larger percentage of the total volume of the jaw muscles in the Anhinga (Table 26).

In considering adduction, it must be remembered that the cormorant grasps its prey, the Anhinga pierces it. The actions required by the cormorant in holding the struggling fish while surfacing and while maneuvering it into position to swallow are quite different from those required of the Anhinga, whose far more passive prey is secured upon its mandibles and has usually been injured in this process. The Anhinga's method of tossing the fish from the mandibles and the catching of it, mandibles well agape, far down in the mouth, again points to considerably different action than that in the cormorant.

Dullemeijer's (1951: 251) diagram of the forces inherent in action of *M. adductor mandibulae externus* in *P. carbo*, points out the great difficulty in comparing the action of this muscle in two species in which the muscle is differently developed. The strikingly different proportions of regions of the muscle in the Anhinga and the cormorant, however, invite a number of generalizations.

The occipital style is far larger in the cormorant, and *caput nuchale* of *M. adductor mandibulae externus*, which in large part arises from the style, is likewise of much greater size in this species. The more extensive develop-

TABLE 26
 VOLUMES OF THE JAW MUSCLES OF THE ANHINGA AND THE CORMORANT EXPRESSED AS
 PERCENTAGES OF THE TOTAL VOLUME OF THESE MUSCLES¹

	Anhinga		Cormorant	
	Extremes	Mean	Extremes	Mean
depressor mandibulae	19.2-22.1	20.7	7.2-10.1	8.2
adductor mandibulae, all parts	25.6-31.1	28.4	51.3-55.1	53.4
pseudotemporalis	7.7-10.9	9.5	4.3-6.3	5.3
pterygoideus ventralis, pterygoideus dorsalis	23.5-34.9	29.6	21.4-23.2	22.4
protractor pterygoideus, protractor quadratus	9.2-13.1	11.5	8.3-11.2	10.2

¹ Based on 2 males and 2 females of each species.

ment of this portion of the muscle points to a much greater power of adduction in the cormorant, as indeed one would expect from its habits, although some speed of adduction may have been sacrificed by the more posterior position of this extended part of the muscle. It may be noted too that the more posterior position of this portion of the muscle affords a considerably greater angle through which force may be applied. Engels (1940: 364) regarded a more caudal position of this muscle (in passerines) as contributing to retraction or drawing backwards of the lower jaw; this action he viewed as advantageous in mouthing objects that resisted adduction. The latter consideration may well be important in the case of the cormorant.

The function of the smaller *caput nuchale* in the Anhinga, which originates likewise in large part from an occipital style, invites speculation. It is known that the Anhinga may seize small fish between its mandibles, although to what extent this is done, there being evidence that even small fish may be impaled, is not known; nor is the extent to which small fish may be utilized in the diet at all clear. Anyone who has observed Anhingas carrying plants, foliated branches, twigs, aquatic growth, and other materials during courtship and nesting activities realize that the species is not inept in mandibular adduction. A factor of importance here is the serration of the edges of the anterior portions of the rhamphothecae of both jaws. Should small fish or other living objects be grasped by the Anhinga, instead of being impaled, these serrations would materially lessen the force of adduction necessary in holding the prey. Indeed, the serrations should materially lessen the force necessary in holding impaled fish too. The force of adduction in the Anhinga may yet be important in other ways. When the head, mandibles agape, is thrown forward on the impaling thrust, the force of adduction would counteract the pressure of the water against the open lower jaw and may be important as well in counteracting the forces at impact that might tend to separate the mandibles.

It is with respect to the latter action that *M. pseudotemporalis* is of particular interest. Its fibers are directed in a posteroventral direction, this being considerably more marked in the Anhinga than in the cormorant. This adductor then, tends to draw the lower jaw anteriorly. That this force may be an important one at impact of the bill with prey is suggested by

the significantly larger percentage of the total volume of the muscles attaching to the jaw that *M. pseudotemporalis* constitutes in the Anhinga in comparison with that in the cormorant (Table 26); a surprising comparison is to be found in the areas of insertion of this muscle, which extends along the jaw in the Anhinga more than twice the length of the area in the cormorant (Fig. 54).

Abduction of the lower jaw.—*M. depressor mandibulae* constitutes more than 20 per cent of the total volume of the jaw musculature in the Anhinga and only about eight per cent of this value in the cormorant (Table 26). This comparatively large value may, to some extent of course, be a reflection of the reduction in volume of the major jaw adductors in the Anhinga. Aside from the large difference in size of this muscle, there are numerous considerations in comparing mandibular abduction in the two species.

In the Anhinga, there is a greater degree of intimacy in the origins of this muscle with the contiguous neck musculature; in two specimens, the origin was even found to extend to the supraoccipital line. These modifications, along with the far more pronounced division of the belly into deep and lateral portions and a greater concentration of fibers about the posterior end of the mandible, may indicate a far more pronounced ability to maintain the mandible in an attitude of abduction as well as greater dexterity in this action.

Numerous conjectures may be introduced at this point. Abduction of the lower jaw may well play an important part in retaining or increasing hold upon impaled fish. That the mandibles are held agape while the bird is submerged has been noted, mandibular abduction here being important. Goodman and Fisher (1962: 88) speculated that a wider skull, and thus a larger pharyngeal cavity, may be correlated with ability to swallow larger fishes. The skull is wide in the cormorant, and large fishes of various shapes are swallowed. Large fish taken by the Anhinga are invariably laterally compressed ones and are usually swallowed in a manner that necessitates extreme abduction of the lower jaw; the pharyngeal cavity is not very wide, but the gular area is greatly distensible in a dorsoventral plane. It may also be noted that during courtship activities, the Anhinga depresses its lower jaw, revealing a gape of imposing depth (the color of the interior skin being a jet black).

Action of the upper jaw: Abduction.—Presence of the cranio-facial hinge in both species indicates that there is considerable motion of the upper jaw. This is effected by *Mm. protractor pterygoideus* and *protractor quadratus*. These form approximately the same percentage of the total volume of the jaw musculature in both species (Table 26). The uniformly great width of the hinge in the cormorant suggests that in this species elevation of the upper mandible is more pronounced and of more frequent occurrence. The structure of the hinge in the Anhinga requires interpretation as to the types of activity during which motion of the upper jaw might be limited; this will be discussed beyond.

Action of the upper jaw: Adduction.—*Mm. pterygoideus ventralis* and *pterygoideus dorsalis* comprise a significantly larger portion of the total volume of the jaw musculature in the Anhinga (Table 26). It therefore might seem that adduction of the upper mandible is of greater functional

significance in this species. This, however, does not readily correlate with the cranio-facial hinge of the cormorant which would certainly seem to afford greater amplitude of upper jaw action in this species. The protuberance (Fig. 47) in the center of the Anhinga's cranio-facial hinge may function as a "stop," effective in resisting longitudinal forces along the mandible, which might be greater than the thin portion of the hinge could withstand. Presumably this stop is effective during impact of the mandible when piercing fish and it would seem that the stop, to be effective, must be held at a definite angle with the frontal bones. While the ligaments of the hinge area have not been critically examined, it seems logical that in the Anhinga synergistic action of both the adductors and abductors of the upper jaw is important in holding the jaw with the stop at a critical angle to the frontal bones. In this connection it may also be noted that the Anhinga and the cormorant differ with respect to the fasciculus of *M. pterygoideus ventralis*, which passes to the anterior edge of the basitemporal. In the Anhinga, this arises largely from the posterior border of the palatine; in the cormorant, it arises in large part from the mesial surface of the belly of *M. pterygoideus ventralis*. Engels (1940: 365) noted the large size of this portion of *M. pterygoideus* in thrashers which engage in digging, and he correlated the development of it with strain placed upon the upper mandible in digging. It is suggested that the fasciculus may well afford greater firmness to the upper jaw of the Anhinga, in holding the jaw with the stop appropriately positioned, during the penetration of the mandibles into prey and during subsequent struggling of the fish.

PHYLOGENETIC IMPLICATIONS OF COMPARISONS OF THE SKULL, JAWS, AND ASSOCIATED MUSCLES

Adaptive modifications are nowhere more evident than in the avian skull and jaw, hence comparisons of these afford evidence of phylogenetic significance which is, at best, usually tenuous. Certain points in the preceding comparison of the Anhinga and the cormorant, however, afford a somewhat more constructive basis for speculation than is often the case.

Both *Anhinga* and *Phalacrocorax* have an occipital style. That this is not an example of convergence seems strongly indicated by inspection of those portions of *M. adductor mandibulae externus* associated with the style and with that portion of this muscle which arises from it. In both species *caput nuchale* of *M. adductor mandibulae externus* arises in large part from the surface of the style, but an anterior portion of the adductor which attaches to *caput nuchale*, arises from the posterior surface of the skull. The insertion of the tendon of *caput nuchale* upon the coronoid process is attended by similar portions of the mandibular adductor in both species.

The style is a far smaller structure in *Anhinga*; whether the style in *Anhinga* is vestigial or rudimentary may be argued. An assumption that the style may have been more highly developed in ancestral forms seems supported by the following arguments.

Grasping is obviously a more primitive use of the bill than impaling. The presence in *Anhinga* of the style in a form reduced to the point that one may question its functional significance with respect to the predominate type of jaw action in securing food suggests a degree of development and significance in ancestral Anhingidae not found in representatives of the

family today. Indeed, the large amount of cartilage now found associated with the style and the fact that the style is sometimes largely cartilaginous indicate that the structure may be a degenerative one. The mandibles, too, afford evidence for speculation. The apparently cartilaginous distal portions of these in *Anhinga*, if they may be considered as degenerative, point to much longer bony mandibles in ancestral forms. This, of course, makes reasonable the possession of an occipital style and the associated portion of *M. adductor mandibulae externus*, grasping, one assumes, having been a more important method of obtaining food than is now the case in *Anhinga*.

Beyond this point, comparisons of the skull are difficult to interpret with respect to phylogeny. Further, it would seem that the phylogenetic significance of deductions concerning the skull will be most profitably considered along with other aspects of the morphology of the two birds, considerations to be made beyond.

FOOD

Audubon (1838: 154) identified numerous vertebrate and invertebrate animals, which he found in stomachs of Anhingas. Wyman (1869: 100) stated that from his observations, Anhingas in Florida live largely on fish, in particular a "species of Bream (*Pomotis*)." According to Bent (1922: 234), fish constitute the main part of the diet. Howell (1932: 93) listed six species of fish, caddis fly larvae, and additional insects as identified in stomach contents examined by the Biological Survey. Sprunt (1954: 21) listed fish, insects, and fruit seeds as food items.

During the investigation, I examined stomachs of seventeen Anhingas (Table 27) collected in fresh-water habitats in south Florida. Three stomachs were empty, three contained small quantities of plant material, twelve, remains of fish, and only one contained an invertebrate which was probably not digested-out from the stomach of an ingested fish.

The nomenclature used for food items in the stomach contents is: fresh water fish, Carr and Goin (1955); marine fish, Longely and Hildebrandt (1941); invertebrates, Pratt (1935) and Hobbs (1942); plants, Small (1933).

The fish identified from the Anhinga stomachs are as follows:

CYPRINODONTIDAE

Lucania goodei Jordan

Fundulus confluentus confluentus Goode and Bean

Fundulus chrysotus Holbrook

?*Floradichthys carpio carpio* (Gunther)

Jordanella floridae Goode and Bean

POECILIDAE

Gambusia affinis (Baird and Girard) subsp.

Heterandria formosa Agassiz

Mollienesia latipinna Le Sueur

CENTRARCHIDAE

Chaenobryttus coronarius (Bartram)

Lepomis punctatus punctatus (Valenciennes)

PERCIDAE

Etheostoma barratti (Holbrook)

Two additional species were identified as they were brought to the surface by Anhingas: three catfish, Ameiuridae, probably *Ameiurus*, and several specimens of *Lepomis macrochirus purpureescens* Cope, Centrarchidae.

Only one individual of the Percidae was found in an Anhinga. These are bottom-dwelling fish which rarely surface. Catfish are bottom-dwellers, but it is a common sight to see numbers of them at the surface in the waters from which these Anhingas were collected. In the three observations of catfish (all large), brought to the surface, the Anhinga was unable to raise its head to initiate tossing the fish free from its mandibles. Instead, the bird swam to shore dragging the fish in the water. Then, by vigorously wiping the mandibles against branches, the catfish was beaten free. The Anhinga made no effort to retrieve the fish it was now free from, but in each case peered down after it as it disappeared in the water. The remains of poeciliids and centrarchids were present in eight and six stomachs, respectively, and cyprinodontids in three stomachs.

TABLE 27
STOMACH CONTENTS OF 14 ANHINGAS COLLECTED IN FRESH WATER AREAS IN SOUTH FLORIDA

Stomach Contents
4 <i>Lucania goodei</i> , 1 <i>Jordanella floridae</i> , 2 <i>Gambusia affinis</i> subsp., 11 unidentified Poeciliidae, 6 <i>Chaenobryttus coronarius</i> , 1 <i>Lepomis punctatus</i> , 5 unidentified Centrarchidae, 3 remains of fish unidentified to Family
Fish bones and scales, chitinous fragments of crayfish
3 <i>Chaenobryttus coronarius</i> (lengths: 80, 95, and 114 mm.), 6 unidentified remains of Centrarchidae
3 <i>Fundulus c. confluentus</i> (lengths: 45, 47, and 72 mm.), 1 ? <i>Floradichthys c. carpio</i> , 5 <i>Lepomis p. punctatus</i> , 8 unidentified Centrarchidae
Rootlets of aquatic plants
4 <i>Lepomis p. punctatus</i> , 2 small bunches of rootlets of aquatic plants
Small unidentified seeds
1 <i>Palaemonetes</i> sp., 4 unidentified Centrarchidae, 1 <i>Etheostoma barratti</i>
2 unidentified remains of Centrarchidae
2 <i>Lucania goodei</i> , 1 <i>Jordanella floridae</i> , 2 <i>Mollienesia latipinna</i> , 2 <i>Gambusia affinis</i> subsp., 2 <i>Lepomis p. punctatus</i> , remains of 1 unidentified Centrarchidae
31 <i>Mollienesia latipinna</i> (longest 66 mm.)
35 <i>Gambusia affinis</i> subsp. (ranging in total length from 26 to 50 mm.)
2 <i>Mollienesia latipinna</i>
1 <i>Chaenobryttus coronarius</i> (total length 132 mm., weight 55.7 grams)

There are several species of fish found commonly in the waters from which the Anhingas were collected but not represented in the stomach contents. These include: *Lepisosteus platyrhincus* De Kay, *Amia calva* Linnaeus, *Notemigonus crysoleucas bosci* (Valenciennes), *Micropterus salmoides floridanus* (Le Sueur), and *Elassoma evergladei* (Jordan). The latter, a very common species, is a bottom-dweller, which rarely rises towards the surface. *Amia calva* is a bottom-dweller too and, like the catfish, is probably too thick-bodied and heavy to be successfully tossed from an impaled position on the mandibles. It is doubtful if an Anhinga could drive its mandibles through a fish with as thick, extensive scales as *Lepisosteus*. *Notemigonus* and *Micropterus* are fast swimming and, from my experience, more wary fishes than those commonly found in Anhinga stomachs.

Those fish taken by the Anhinga in south Florida are in general not bottom dwellers, they are rather slow-swimming species, and, most important, they are not thick-bodied. Indeed the latter point has been stressed

TABLE 28
STOMACH CONTENTS OF 11 CORMORANTS COLLECTED IN SOUTH FLORIDA

Habitat	Stomach Contents
Fresh water	1 ? <i>Ameiurus nebulosus marmoratus</i>
Fresh water	1 <i>Lepisosteus platyrhincus</i> (total length 449 mm., weight 201.8 grams)
Marine	2 <i>Opsanus beta</i> (total lengths of headless remains: 110 and 140 mm.)
Marine	4 <i>Opsanus beta</i> (1 intact specimen with a total length of 142 mm.)
Marine	1 <i>Opsanus beta</i> (total length 145 mm.)
Marine	2 <i>Bagre marina</i> (1 intact specimen with total length of 210 mm., partly digested specimen with total length of remains 193 mm.),
	2 <i>Opsanus beta</i> (remains only, these with total lengths of 86 and 125 mm.)
Marine	3 ? <i>Myrichthys acuminatus</i> (intact remains with total lengths of: 265, 310, and 350 mm.)
Marine	3 <i>Opsanus beta</i> (one intact with a total length of 155 mm.)
Marine	1 <i>Opsanus beta</i> (total length of remains 136 mm.)
Marine	3 <i>Pitho anisodon</i> , 1 <i>Opsanus beta</i> (total length of remains 165 mm.) Weight of stomach mass 80 grams.
Marine	4 <i>Sparisoma</i> sp. (total length of longest 120 mm.)

but little heretofore. Habitat selection by the Anhinga is no doubt greatly influenced by the absence or presence of laterally flattened fish. The Anhinga has become adapted for taking this shape of prey.

The large sizes and quantities of fish taken by the Anhinga have often been commented upon. Audubon (1838: 143) fed a tame Anhinga a fish nine and one-half inches in length. Later, in succession, he fed this bird nine fish, each of which exceeded seven inches in length. If these were presented to this tame bird so that it did not have to impale them and toss them free from its mandibles, then these records are not necessarily indicative of the sizes of fish which may be taken under natural conditions. The largest fish I found in an Anhinga stomach was a Warmouth, *Chaenobryttus coronarius* (Bartram), which weighed 55.7 grams and was 132 millimeters long and 45 millimeters deep. One stomach contained remains of 37 fish; eleven of these were centrarchids, the measurable remains of which ranged from 37 to 57 millimeters in length. From another stomach, remains of nine centrarchids ranging in total length from 50 to 114 millimeters were taken. The contents of the stomach of one Anhinga weighed 105.3 grams—more than seven per cent of the bird's total weight.

Chitinous fragments of crayfish were commonly found in stomach contents. Audubon (1838: 144) described the swallowing of a crayfish by an Anhinga. It is my opinion, however, that the crayfish remains I examined had been digested out from the stomachs of fish which had been swallowed. One large centrarchid from an Anhinga stomach contained a fresh specimen of *Procambarus alleni* (Faxon), which measured 45 millimeters in total length. An undigested fresh-water shrimp, *Palaemonetes* Heller (sp.) was found in one stomach. This is a crustacean of delicate structure and it had probably been eaten directly by the Anhinga. It is at times a very common species in these waters, but apparently it is not taken with frequency.

Two stomachs contained small clusters of rootlets of aquatic plants, probably those of *Pistia Stratiotes* Linnaeus, the Water Lettuce. These rootlets may have been accidentally swallowed along with fish. Anhingas dive, swim, and hunt through floating mats of these plants. Fifteen small seeds, each less than two millimeters in diameter, were taken from an otherwise empty stomach; these were not identified.

Twelve stomachs from cormorants collected in south Florida were examined. Nine were taken from marine habitats and three from fresh-water areas. Individual stomach contents are enumerated in Table 28.

Of the nine stomachs from birds collected in marine habitats, seven contained remains of *Opsanus beta* Goode and Bean, a toadfish of the Family Batrachoididae. Two specimens of *Bagre marina* (Mitchill), Family Ariidae, were taken from one stomach and four Scaridae of the genus *Sparisoma* Swainson (sp.) were taken from another. Three partly digested, but largely intact, eel-like fishes, probably *Myricthys acuminatus* (Gronow), Family Opichthyidae, were found in an otherwise empty stomach. Three intact carapaces and attached appendages of a crab, *Pitho anisodon* (von Martens), were found in a stomach containing partly-digested remains of an *Opsanus beta*. These may have been digested-out from stomachs of fish, but their state of entirety did not suggest it. Pelecypod valves, often found in the cormorant stomachs, are possibly accidentally ingested during swallowing of fish taken from the ocean bottom.

The marine forms listed above are bottom-dwelling or reef-inhabiting. Scattergood's (1950: 507) records of stomach contents of Double-crested Cormorants taken at Pensacola, Florida, also include bottom-dwelling forms. He further found Striped Mullet, *Mugil cephalus* Linnaeus, and from cormorants taken elsewhere he listed Mackerel, *Scomber scombrus* and "Herring." Taking of these fish implies active pursuit of them.

Of three stomachs from cormorants collected in fresh water, one was empty and the other two contained fish. One contained partly digested remains of species of the Family Centrarchidae and a large Spotted Gar, *Lepisosteus platyrhincus* De Kay, Family Lepisosteidae. The other contained remains of a large catfish, Family Ameiuridae, probably *Ameiurus nebulosus marmoratus* (Holbrook). I have often seen cormorants surface in fresh water with centrarchids between their mandibles.

The *Lepisosteus* record requires special comment. This gar was removed alive from the esophagus of a cormorant collected from a flock fishing in a large, flooded borrow-pit, the waters of which were heavily populated with gars. The remaining cormorants of the flock took off from the water, some with difficulty. The cormorant collected was apparently unable to become air-borne, despite a long up-wind run. The *Lepisosteus* measured 449 millimeters in total length, 117 millimeters in girth, and had a weight of 201.8 grams. The weight of the cormorant, without that of the *Lepisosteus*, was 2,030.3 grams. Indication of the weight which will increase the wing-loading of the cormorant to a critical point is here afforded.

Lewis (1929: 68) and Mendall (1936: 80) cited U. S. Biological Survey records of *Micropterus salmoides*, probably *Micropterus s. floridanus* (Le Sueur), and *Chaenobryttus*, respectively, both taken from cormorants collected at a slough at Royal Palm Hammock (probably the Royal Palm Hammock in Dade County).

SUMMARY

In south Florida, the Anhinga and the cormorant are almost exclusively fish-eaters. In marine habitats, the cormorant feeds to a considerable extent upon the bottom fauna; whether it is a bottom-feeder in fresh-waters of this area is not indicated. In fresh-water areas the Anhinga is apparently not a bottom-feeder. Both species feed on slow-swimming centrarchids. There is a single record of the cormorant taking a bass, *Micropterus*. It is not known to what extent these may be taken. It is doubtful if the Anhinga usually catches such wary, fast-swimming fish. Because it seizes fish in its mandibles, the cormorant is able to exploit the large populations of *Lepisosteus* and *Ameiuridae*, while the Anhinga is unable to impale these fish, or if, in the case of the catfish, large individuals are impaled, to toss them from its mandibles. Thus, although both species may fish the larger bodies of fresh water in south Florida, their somewhat different fish-catching abilities may reduce any competition for the food supply.

CONCLUSIONS:
THE ANHINGA AND PHALACROCORACIDAE

Anhingas and cormorants are of similar appearance. Both have long necks and long mandibles, have totipalmate feet, and are largely black. In addition, both are piscivorous and fish underwater. Both frequent similar, at times identical, habitats. The scrutiny given in the present investigation to broad aspects of the anatomy emphasizes that similarity between the two is to a considerable extent superficial, there being profound differences in basic morphology.

The very different methods by which the Anhinga and the cormorant obtain fish have been stressed in the preceding discussion. Their adaptations for fishing are in degree of difference commensurate with the differences in fishing characteristic of other families of the Pelecaniformes. And as in the case of these other families, while ecological ranges of the species may overlap, both appear to be most proficient in quite different habitats.

Adaptation in the Anhingidae and Phalacrocoracidae has proceeded along the following general lines. The cormorant exhibits a far greater degree of specialization for active pursuit of fish than does the Anhinga, its pelvic appendage being modified for powerful and rapid swimming. The cormorant's skull is adapted for powerful prehension. Comparisons of the pectoral appendage likewise indicate wide divergence in adaptation of the two. The powerful and laborious flight of the cormorant, its heavy wing-loading, and its obvious preference for areas of unobstructed expanses of open water, suggest that its modifications for an aquatic environment have brought it close to the maximum potential of such modifications concomitant with proficient flight.

The Anhinga, on the other hand, has achieved proficiency in an aquatic environment through adaptations which emphasize slow, prowling progression under water. Prey is usually approached by stealth and pierced with a thrust of the mandibles. Far less buoyant, an adaptation which facilitates its remaining submerged while swimming slowly, it does not remain long in the water after prey is secured. It seldom flies from the water, its soaked plumage impeding flight, and the dense growth about the ponds it frequents further restricts its ability to rise from the water's surface. Heavy muscularization and other profound modifications of the hind limb for rapid swimming being lacking in the Anhinga, the leg and foot are relatively efficient in climbing and perching. The more generalized hind-limb modifications, light wing-loading and marked specialization of the pectoral limb and remiges adapt it for maneuverability in flying about forest-surrounded ponds and for soaring above the forest canopy.

Mayr *et al.* (1953: 53) pointed out that there is a basic structural pattern characteristic of the higher taxonomic categories and that these taxa are, in general, "definable in terms of basic structural pattern." They further observed that each of the families of an order "occupies a particular and usually distinctive ecological niche." That anhingas and cormorants—and here I assume that the Double-crested Cormorant is representative of the other species of the family—are quite differently patterned structurally and that they occupy quite distinct ecological niches seems patent.

It remains to scrutinize the morphological findings of this investigation

from a taxonomic point of view. Many individual differences in osteology and myology between the two birds have already been commented upon. But to select from these many differences any or several which may be viewed as having undisputed taxonomic significance appears a hopeless task. Entire complexes of differences, however, such as have been afforded by consideration of the wing, the tail, the leg, and the skull do offer a basis for taxonomic consideration. Such complexes, or better still, the total of these several complexes, would appear suitably conservative criteria for delimiting taxa of higher category than species and genus.

The very different proportions of the skeletal elements of the pectoral appendage, the multitude of differences in the myology of the appendage, and the differences in the ptilosis of the wing appear to be profound differences. The differences in the osteology, myology, and ptilosis of the tail appear to be of similar import. Again, the very different proportions of the synsacrum and the modifications of the skeletal elements of the leg as well as the conspicuous differences in the myology of this limb appear profound. The skull, it is true, affords certain evidences of similarity, but, in other respects than the occipital style and certain muscles associated with the style, features of the skull are very different. (In every family of this order one would expect to find as convincing evidences of relationship.) Viewed as but a *single* complex the heads of the two are quite different.

I incline towards conservatism in delimiting taxa, particularly the higher categories. Evidence to the contrary from a combination of fields being lacking, I recommend that separate family rank be retained for aningas and cormorants. The present investigation affords, it is argued, important evidence in support of this recommendation.

LITERATURE CITED

- AMADON, D. 1943. Bird weights as an aid in taxonomy. *Wilson Bull.*, 55: 164-177.
- AUDUBON, J. J. 1838. An ornithological biography. Vol. 4: 136-160. Adam and Charles Black, Edinburgh. 618 pp.
- BAILEY, T. J. 1959. Statistical methods in biology. John Wiley & Sons, Inc., New York. 200 pp.
- BEDDARD, F. E. 1892. Notes on the anatomy and osteology of the Indian Darter (*Plotus melanogaster*). *Proc. Zool. Soc. Lond.*, 1892: 291-296.
- BEDDARD, F. E. 1898. The structure and classification of birds. Longmans, Green and Co., London. 548 pp.
- BENT, A. C. 1922. Life histories of North American petrels and pelicans and their allies. *Bull. U. S. Nat. Mus.*, 121: 1-343.
- BERGER, A. J. 1956a. The appendicular myology of the Sandhill Crane, with comparative remarks on the Whooping Crane. *Wilson Bull.*, 68: 282-304.
- BERGER, A. J. 1956b. Anatomical variation and avian anatomy. *Condor*, 58: 433-441.
- BLAKE, C. H. 1956. The topography of a bird. *Bird Banding*, 27: 22-31.
- BOAS, J. E. V. 1929. Biologisch-Anatomische Studien über den Hals der Vögel. *Kongl. Danske Videnskab. Selsk., Naturvidensk. og Mathem. Afd.*, 9. Raekke, 1(3): 105-222.
- BOAS, J. E. V. 1933. Kreuzbein, Becken und *Plexus lumbrosacralis* der Vögel. *Kongl. Danske Videnskab. Selsk., Naturvidensk. og Mathem. Afd.*, 9. Raekke, 5(1): 5-74.
- BROOKS, A. 1945. The under-water actions of diving ducks. *Auk*, 62: 517-523.
- CARR, A. F., JR., and C. J. GOIN. 1955. Guide to the reptiles, amphibians and fresh-water fishes of Florida. Univ. Fla. Press, Gainesville. 341 pp.
- CAZIN, M. 1884. Note sur la structure de l'estomac du *Plotus melanogaster*. *Ann. Sci. Nat.*, 6(18), Art. 3: 1.
- CHANDLER, A. C. 1916. A study of the structure of feathers, with reference to their taxonomic significance. *Univ. Calif. Publ. Zool.*, 13(11): 243-446.
- CHAPIN, J. P. 1932. Birds of the Belgian Congo. *Bull. Amer. Mus. Nat. Hist.*, 65(1): 3-530.
- CHAPMAN, F. M. 1930. Handbook of birds of eastern North America. Rev. ed. D. Appleton and Co., New York. 530 pp.
- COUES, E. 1927. Key to North American birds. II. 6th ed. Page Co., Boston. 537-1152 pp.
- DABELOW, A. 1925. Die Schwimmanpassung der Vögel. Ein Beitrag zur biologischen Anatomie der Fortbewegung. *Morph. Jahrbuch*, 54: 288-321.
- DULEMEIJER, P. 1951. The correlation between muscle system and skull structure in *Phalacrocorax carbo sinensis* (Shaw and Nodder). pts. I-IV. *Nedl. Akad. Wet. Amsterdam, Proc., Ser. C*, 54: 247-259; 400-404; 533-536. 53: 95-102.
- ENGELS, W. L. 1940. Structural adaptations in thrashers (Mimidae: Genus *Toxostoma*) with comments on interspecific relationships. *Univ. Calif. Pub. Zool.*, 42(7): 341-400.
- ENGELS, W. L. 1941. Wing skeleton and flight of hawks. *Auk*, 58: 61-69.
- FISHER, H. I. 1946. Adaptations and comparative anatomy of the locomotor apparatus of New World vultures. *Amer. Midl. Nat.*, 35: 545-727.
- FISHER, H. I. 1957. The function of *M. depressor caudae* and *M. caudofemoralis* in pigeons. *Auk*, 74: 479-486.
- FISHER, H. I., and D. C. GOODMAN. 1955. The myology of the Whooping Crane, *Grus americana*. III. *Biol. Monogr.*, 24(2): 1-127.
- FORBES, W. A. 1882. On some points in the anatomy of the Indian Darter (*Plotus melanogaster*) and on the mechanism of the neck in the darters (*Plotus*), in connexion with their habits. *Proc. Zool. Soc. Lond.*, 1882: 208-212.
- FRIEDMANN, H. 1930. Birds collected by the Childs Frick Expedition to Ethiopia and Kenya Colony. Part I. *Bull. U. S. Nat. Mus.*, 153: 1-516.
- GARROD, A. H. 1874. On certain muscles of birds and their value in classification. Part II. *Proc. Zool. Soc. Lond.*, 1874: 111-123.
- GARROD, A. H. 1876a. Notes on the anatomy of *Plotus anhingae*. *Proc. Zool. Soc. Lond.*, 1876: 335-345.
- GARROD, A. H. 1876b. On the anatomy of *Chauna derbiana*, and on the systematic position of the screamers (*Palamedeidae*). *Proc. Zool. Soc. Lond.*, 1876: 189-200.
- GARROD, A. H. 1878. Notes on points in the anatomy of Levaillant's Darter (*Plotus levaillantii*). *Proc. Zool. Soc. Lond.*, 1878: 679-681.
- GOODMAN, D. C., and H. I. FISHER. 1962. Functional anatomy of the feeding apparatus in waterfowl. *Aves: Anatidae*. S. Ill. Univ. Press, Carbondale. 193 pp.

- GRAHAM, R. R. 1932. The part played by the emarginated feathers and the alula in the flight of birds. *Bull. Brit. Ornith. Club*, 52: 68-79.
- HEINROTH, O. 1898. Schwingen- und Schwanzmauser der Vögel. *Sitzungsber. Ges. naturf. Freunde*, Berlin, 1898: 96-118.
- HOBBS, H. H., JR. 1942. The crayfishes of Florida. *Univ. Fla. Publ. Biol. Sci. Ser.*, 3(2): 1-179.
- HOFER, H. 1950. Zur Morphologie der Kiefern-muskulatur der Vögel. *Zoologische Jahrbücher*, 70: 427-556.
- HOWARD, H. 1929. The avifauna of Emeryville Shellmound. *Univ. Calif. Publ. Zool.*, 32(2): 301-394.
- HOWELL, A. H. 1932. Florida bird life. Fla. Dept. Game and Fresh Water Fish and Coward-McCann, Inc., New York. 579 pp.
- HUDSON, G. E. 1937. Studies on the muscles of the pelvic appendages in birds. *Amer. Midl. Nat.*, 18: 1-108.
- HUDSON, G. E., and P. J. LANZILLOTTI. 1955. Gross anatomy of the wing muscles in the Family Corvidae. *Amer. Midl. Nat.*, 53(1): 1-44.
- LAKJER, T. 1926. Studien über die Trigemini-versorgte Kaumuskelatur der Säuropsiden. Bianco Lunos Buchdruckerei, Kopenhagen. 154 pp.
- LEWIS, H. F. 1929. The natural history of the Double-crested Cormorant (*Phalacrocorax auritus auritus*) (Lesson). Ru-Mi-Lou Books, Ottawa. 94 pp.
- LONGLEY, W. H., and S. F. HILDEBRANDT. 1941. Systematic catalogue of the fishes of the Tortugas, Florida. Carnegie Inst. Wash., Publ. 535. 331 pp.
- MACKWORTH-PRAED, C. W., and C. H. B. GRANT. 1952. African handbook of birds. I. Birds of eastern and north eastern Africa. I. Longmans, Green and Co., London. 836 pp.
- MAYR, E., and D. AMADON. 1951. A classification of Recent birds. *Amer. Mus. Nat. Hist., Novit.*, 1496: 1-42.
- MAYR, E., E. G. LINSLEY, and R. L. USINGER. 1953. Methods and principles of systematic zoology. McGraw-Hill Book Co., N. Y. 328 pp.
- MCATEE, W. L., and H. L. STODDARD. 1945. Wetable water birds. *Auk*, 62: 303-304.
- MEANLEY, B. 1954. Nesting of the Water-turkey in eastern Arkansas. *Wilson Bull.*, 66: 80-88.
- MEINERTZHAGEN, R. 1935. Ornithological results of a trip to Syria and adjacent countries in 1933. *Ibis*, Ser. 13, 5: 110-151.
- MENDALL, H. L. 1936. The home-life and economic status of the Double-crested Cormorant. *Maine Bull.*, 39(3): 1-159.
- MILLER, A. H. 1937. Structural modifications in the Hawaiian Goose (*Nesochen sandvicensis*). A study in adaptive evolution. *Univ. Calif. Publ. Zool.*, 42(1): 1-80.
- MITCHELL, P. C. 1913. The peroneal muscles in birds. *Proc. Zool. Soc. Lond.*, 1913, 2: 1039-1072.
- MIVART, ST. G. 1879. On the axial skeleton of the Pelecanidae. *Trans. Zool. Soc. Lond.*, 10: 315-378.
- MONTAGNA, W. 1945. A re-investigation of the development of the wing of the fowl. *J. Morph.*, 76: 87-113.
- NEWTON, A., and H. GADOW. 1893-1896. A dictionary of birds. Adam and Charles Black, London. 1088 pp.
- PETERS, J. L. 1931. Check-list of birds of the world. I. Harvard Univ. Press, Cambridge. 345 pp.
- POOLE, E. L. 1938. Weights and wing areas in North American birds. *Auk*, 55: 511-517.
- PRATT, H. S. 1935. A manual of the common invertebrate animals, exclusive of insects. Rev. ed. P. Blakiston's Son and Co., Inc., Phila. 854 pp.
- PYCRAFT, W. P. 1898. Contributions to the osteology of birds. Part I. *Steganopodes*. *Proc. Zool. Soc. Lond.*, 1898: 82-101.
- READ, A. C. 1909. From the Isle of Pines. *Oologist*, 26:165-166.
- REID, G. K., JR. 1954. An ecological study of the Gulf of Mexico fishes, in the vicinity of Cedar Key, Florida. *Bull. Mar. Sci. Gulf and Caribbean*, 4: 1-94.
- RICHARDSON, C. H. 1944. An introduction to statistical analysis. Harcourt, Brace and Co., New York. 498 pp.
- SCATTERGOOD, L. W. 1950. Observations on the food habits of the Double-crested Cormorant, *Phalacrocorax a. auritus*. *Auk*, 67: 506-508.
- SHARPE, R. B. 1891. A review of recent attempts to classify birds. *Comm. of II. Ornith. Congress, Budapest*. 90 pp.
- SHARPE, R. B., and W. R. OGILVIE-GRANT. 1898. Catalogue of the Plataleae, Herodiones,

- Steganopodes, Pygopodes, Alcae, and Impennes in the collection of the British Museum. Catalogue of the Birds in the British Museum, 26. Taylor and Francis, London. 687 pp.
- SHUFELDT, R. W. 1890. The myology of the raven (*Corvus corax sinuatus*). Macmillan and Co., New York. 343 pp.
- SHUFELDT, R. W. 1902. The osteology of the Steganopodes. Mem. Carnegie Mus., 1(3): 109-223.
- SHUFELDT, R. W. 1913. On the patella in the Phalacrocoracidae. Proc. Zool. Soc. Lond., 1913, 2: 393-402.
- SMALL, J. K. 1933. Manual of the southeastern flora. Privately printed, New York. 1554 pp.
- SPRUNT, A., JR. 1954. Florida bird life. Natl. Aud. Soc. and Coward-McCann, Inc., New York. 527 pp.
- STOLPE, M. 1932. Physiologisch-anatomische Untersuchungen über die hintere Extremität der Vögel. Jour. für Ornithologie, 80: 161-247.
- STORER, J. H. 1948. The flight of birds. Cranbrook Inst. Sci., Bull. 28: 1-94.
- VERHEYEN, R. 1953. Exploration du parc national de l'Upemba. Mission G. F. De Witte. Fasc. 19, Oiseaux. M. Hayez, Bruxelles. 687 pp.
- VIRCHOW, H. J. P. 1917. Ueber die Halswirbelsäule von *Plotus anhinga*. Sitzungsber. Ges. naturf. Freunde, Berlin. 1917: 454-468.
- WETMORE, A. 1951. A revised classification for the birds of the world. Smithson. Misc. Coll., 117(4): 1-22.
- WILCOX, H. H. 1952. The pelvic musculature of the loon, *Gavia immer*. Amer. Midl. Nat., 48: 513-573.
- WYMAN, J. 1869. On a thread worm (*Filaria anhinga*) infecting the brain of the snake-bird, (*Plotus anhinga* Linn.). Proc. Boston Soc. Nat. Hist., 12: 100-104.

ORNITHOLOGICAL MONOGRAPHS

- No. 1. **A Distributional Study of the Birds of British Honduras**, by Stephen M. Russell. 195 pp., 2 color plates. Price \$4.50 (\$3.60 to AOU members).
- No. 2. **A Comparative Study of Some Social Communication Patterns in the Pelecaniformes**, by Gerard Frederick van Tets. 88 pp., 49 text figures. Price \$2.00 (\$1.60 to AOU members).
- No. 3. **The Birds of Kentucky**, by Robert M. Mengel. Cloth bound, xiv + 581 pp., 4 color plates plus text figures and vignettes. Price \$10.00 (\$8.00 to AOU members).
- No. 4. **Evolution of Some Arctic Gulls (*Larus*): an Experimental Study of Isolating Mechanisms**, by Neal Griffith Smith. 99 pp., 62 text figures. Price \$2.50 (\$2.00 to AOU members).
- No. 5. **A Comparative Life-history Study of Four Species of Woodpeckers**, by Louise de Kiriline Lawrence. 156 pp., 33 text figures. Price \$3.75 (\$3.00 to AOU members).
- No. 6. **Adaptations for Locomotion and Feeding in the Anhinga and the Double-crested Cormorant**, by Oscar T. Owre. 138 pp., 56 text figures. Price \$3.50 (\$2.80 to AOU members).

Like all other AOU publications, *Ornithological Monographs* are shipped prepaid. Make checks payable to "The American Ornithologists' Union." For the convenience of those who wish to maintain complete sets of *Ornithological Monographs* and to receive new numbers immediately upon issue, standing orders will be accepted.

Order from: **Burt L. Monroe, Sr., Treasurer, American Ornithologists' Union, Box 23447, Anchorage, Kentucky 40223**