

# MECHANICS OF THE SYRINX IN *GALLUS GALLUS*.

## I. A COMPARISON OF PRESSURE EVENTS IN CHICKENS TO THOSE IN OSCINES

ABBOT S. GAUNT

SANDRA L. L. GAUNT

AND

DWIGHT H. HECTOR

A recent study (Gaunt et al. 1973) of gas pressure and flow in a vocalizing oscine (*Starling*, *Sturnus vulgaris*) produced unexpected results. First, while pressure in the air sacs during a distress call usually rose to 40 times that of ventilatory exhalation, pressure in the trachea, "downstream" from the syrinx, was commonly lower than during exhalation; indeed, it often scarcely exceeded atmospheric pressure. Second, despite the increased pressure head, which tended to persist for twice as long as an exhalation, the volume of gas exhaled increased by no more than a third, and often was similar to that seen in excited ventilation. Third, if pressure within the air sacs (especially the interclavicular) was allowed to drop by flow through a cannula, both vocalization and flow through the trachea ceased, even in the presence of relatively high air sac pressures.

These combined observations suggest that the oscine syrinx somehow imparts a high resistance to flow during vocalization. In effect, the syrinx acts as a nozzled valve. Although the column of moving air that activates the membrane(s) may have a high velocity, the cross-sectional diameter of the column is small, and remarkably little air is consumed by the vocalizing process. We have hypothesized that such a valve would provide a strong selective advantage during vocalization by increasing both the loudness (related to air velocity) and duration (related to air consumption) of the call.

The exact nature of the valve in oscines is not known. However, our experiments indicate that it probably involves a structure that is controlled by muscular activity rather than pressure events. Hence, it is probably a more substantial structure than a vibrating membrane. The studies of Chamberlain et al. (1968), Greenewalt (1968), and Stein (1968) suggest that an appropriate structure would be the external labium (EL), and the models we have proposed (Gaunt and Wells 1973, fig. 10) assume that to be the case.

Oscines generally (always?) have an EL, while non-passerines generally lack it. It is certainly absent from chickens, and the labia associated with the bullae of some male anatids show a quite different structure. The syrinx of chickens also differs from that of oscines in the nature and position of the vibrating membranes. A chicken's syrinx is tracheo-bronchial (fig. 1). Just anterior to the syrinx the final four rings of the trachea are fused into a "drum." The pessulus is a dorsoventrally-oriented, cartilaginous bar in the medial plane marking the divergence of the bronchi from the trachea. The ends of this bar are expanded into triangular plates at the dorsal and ventral surfaces, giving it a dumbbell-like appearance. Between the posterior end of the drum and the pessulus, the trachea is strongly laterally compressed. Its walls are essentially membranous, comprising the external tympaniform membranes, the anterior portions of which are invested by cartilaginous partial rings. Hence, the external tympaniform membranes are directly opposed to each other in this region. They continue posteriad onto the bronchi where they are also opposed by the internal tympaniform membranes. Experiments by Gross (1964b) indicated that the external tympaniform membranes are the major source of sound production in chickens.

In contrast, the sound-producing membranes of oscines are the internal tympaniform membranes lying at the anterior end of the medial surface of each bronchus. They are not opposed by another membrane, but by either the EL or the outer walls of the bronchi, depending upon the species.

Although pressure changes in the air sacs during vocalizations of chickens have been investigated (Brackenbury 1972, Gross 1964a), no study deals with simultaneous pressure events on either side of the syrinx. Such a study would be of dual interest. It would provide basic information of pressure events in a simpler (i.e., fewer muscles, no EL) and presumably more primitive syrinx than that of



FIGURE 1. Syrinx of a chicken, in situ. B, bronchus; D, drum; ETM, external tympaniform membrane; m. ST, sternotrachealis; P, pessulus; T, trachea. Anterior toward bottom right. Note lateral compression of trachea between the drum and the pessulus.

starlings. Also, it would provide a test of the hypothesis that the EL does serve oscines as a valve that can regulate air flow according to the following reasoning. If the EL does reduce the volume of air exhausting into the trachea, then its absence should be reflected in pressure patterns observed during vocalization. Specifically, tracheal pressures should track air sac pressures more closely, rising well above atmospheric and showing only such modifications as would be imparted by the resistance of the air passageways and the activities of the vibrating, vocal membranes. Conversely, if a species without an EL were to duplicate the pressure patterns recorded from starlings, we would be forced to admit at least that alternative mechanisms must exist. The test is indirect, hence not definitive, but it can serve either to lend or deny credence to our initial hypothesis.

## METHODS AND MATERIALS

A number of preliminary experiments were performed on pen-raised, wild-type mallard drakes (*Anas platyrhynchos*) from local game farms. These birds proved undesirable for extensive experimentation because our instruments did not display their calls well, and because of their excitability and the lack of variety in the vocalizations. Records we obtained from ducks completely parallel those from chickens. Hence, we present only one (fig. 4) for comparison. Other data

obtained from ducks will be discussed where appropriate.

Most of our experiments were performed on twelve, adult roosters (*Gallus gallus*) of various breeds, but two hens were also used. We selected chickens as our primary experimental animals for several reasons. First, the anatomy of the chicken's syrinx is well-known, thanks to the work of Gross (1964a,b), Myers (1917), Tymms (1913), Warner (1969), and Youngren et al. (1974). Second, air sac pressures related to the vocalizations of chickens have been studied (Brackenbury 1972, Gross 1964a). Third, chickens utter a wide variety of calls, most of which are easily elicited and some of which are of spectacular intensity. Finally, chickens are of a convenient size for surgical procedures.

Measured parameters were recorded simultaneously on a Beckman "Dynograph" multi-channel chart recorder. This device can display signals such as sound or electromyographs (EMG) in either an averaging or a direct mode. Averaging is of both amplitude and frequency for a period of 0.2 sec. Thus, the height of the resulting curve is, to some extent, a measure of the strength of the signal. Although the integrate mode shows the onset of the signal well, the averaging circuitry delays the return of the pen to the zero position at the end of the signal. Therefore, some records were taken in the direct mode, which does show the onset and cessation of the sound quite sharply, but, because the frequency range of the signals was well beyond the oscillatory capability of the pen drive, it does *not* display the true wave form. Further, weak signals are not easily separated from noise in the direct mode. Hence, most of our recordings used the integrate mode.

Sound signals were detected by a Brush BA-106 microphone and boosted by a Tectronix FM-122 pre-amplifier. Even so, some calls, especially the soft "rüb-rüb" of mallards, did not record well, and it was occasionally necessary to mark the record by hand.

## SURGICAL PROCEDURES

All surgery was performed under semi-sterile conditions. Some operations were performed with general anesthesia (either "Equi-Thesin," from Jensen-Salsbery Laboratories, or sodium pentobarbital). However, unlike starlings, ducks and chickens showed severe aftereffects from such procedures, and recovery times were often prolonged. We therefore changed to a local anesthetic ("Xylocane" [= (Lidocaine) HCl] from Astra Pharmaceutical), which proved effective for most experiments. For some procedures, as in penetration of the interclavicular air sac, birds were also given a tranquilizing dose of "Equi-Thesin." Birds returned to normal behavior rapidly after surgery with only "Xylocane" or the combination, and we were sometimes able to record within minutes following the completion of surgery.

## CANNULATION PROCEDURES

All pressures were recorded through chronically implanted cannuli. Most pressures from the air sacs were recorded from the posterior thoracic air sac, but a few records were taken from the interclavicular air sac. Cannuli consisted either of large gauge (1.6–2.4 mm I.D.) polyethylene tubing or surgical rubber tubing. We preferred the latter as it proved more flexible and less irritating to the birds. It also had a larger internal bore (3.0 mm I.D.), which

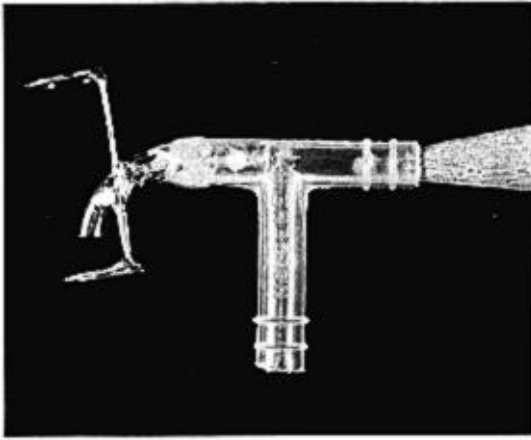

FIGURE 2. Tracheal pressure probe. Cannula is attached to vertical bar of T-joint, which may be sutured to skin of neck for additional strength. The device can be cleaned by inserting a vacuum line into the horizontal bar (at position of pencil point) of the T-joint. This outlet is plugged during recording.

served to reduce problems of damping and impedance within the cannulation system.

Our pressure implant to the trachea was a bent section of a 15-gauge hypodermic needle welded to a fine wire framework (fig. 2). The entire device could be inserted into the trachea through a very small longitudinal incision. The protruding end of the needle was held in place by a suture through the skin and around the crossbar welded to the tubing. The frame held the internal end of the needle in the center of the tracheal lumen, thus decreasing chances of mucoid clogging and assuring that the opening to the cannula was near the center of the flow profile. The apparatus was held in place by the elasticity of the trachea. A correctly implanted device produced little tissue trauma and could be left in place indefinitely.

Surgical tubing led from our implanted cannuli to Statham PM-5 differential pressure transducers. Birds proved remarkably tolerant of both the implants and the associated tubing.

As part of our EMG study of the chicken's vocal system (Gaunt, A. S. and Gaunt, S. L. L., in press), we recorded electrical activity in the muscles that compress the abdomen, primarily the external oblique and the transverse abdominis, but probably including some signals from the internal oblique and the rectus abdominis (Kadono et al. 1963). We report here EMG activity during repetitive clucking as this is critical to some of our interpretation. EMG signals were obtained from Beckman miniature skin electrodes placed over the abdominal muscles. No preamplification other than that provided by the "Dynograph" was necessary.

Our birds were unrestrained during all experiments. Vocalizations were ad libitum, although we encouraged specific calls by presenting appropriate stimuli.

For a few of our later experiments, the microphone and pressure transducers were connected directly to a Honeywell 5600-C medical tape recorder. This permitted us to replay interesting records at a variety of amplifications and chart speeds and, in one case (fig. 6B), to photograph an oscilloscope tracing of a critical section.

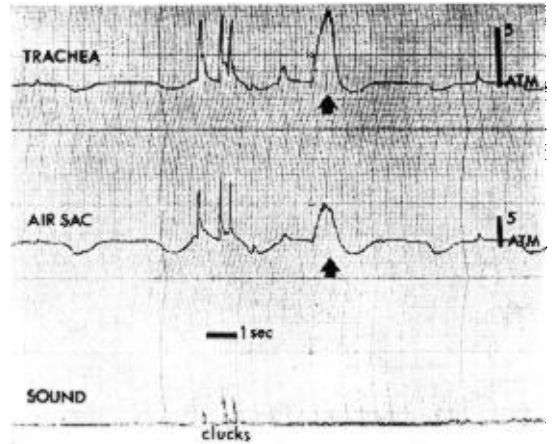

FIGURE 3. Pressure changes not associated with vocalization. Three clucks followed by a change of unknown cause (arrow). Vertical bars extend from atmospheric to +5 cm H<sub>2</sub>O.

## RESULTS AND ANALYSIS

### NORMAL VENTILATION

Except in excited birds, pressure patterns of normal ventilation are notably regular (figs. 3-5, 8), and the pressure fluctuation to either side of atmospheric is small. If the bird becomes highly excited, the amplitudes of deflection increase, and the pattern becomes less regular.

Ventilatory pressures in the air sacs of chickens are usually between  $\pm 1$  to  $\pm 1.5$  cm H<sub>2</sub>O, rarely more than  $\pm 2$  cm H<sub>2</sub>O. In ducks the range is between  $\pm 0.75$  and  $\pm 1$  cm H<sub>2</sub>O. Tracheal pressures for any given breath tend to be almost half the value measured in the air sac. Occasionally a bird may generate pressures amounting to several cm H<sub>2</sub>O without vocalizing (figs. 3 and 4 "Drake"). In such an instance, tracheal pressures exactly parallel air sac pressures, differing only in magnitude.

### VOCALIZATIONS

We have designated all the vocalizations we studied either "clucks" or "long" sounds. Clucks may be distinguished not only by their brevity, but also by a distinct explosive quality. The "rüb-rüb" of mallards is here considered to be a cluck.

The chickens were most cooperative in producing a wide variety of long sounds including growls, crows (henceforth called "crowing" to avoid confusion with a notorious group of oscines), and a loud, gasping wail. The wail may represent an extreme version of the growl in terms of both sound production and behavioral context. It is not given by all cocks, and is most commonly heard from

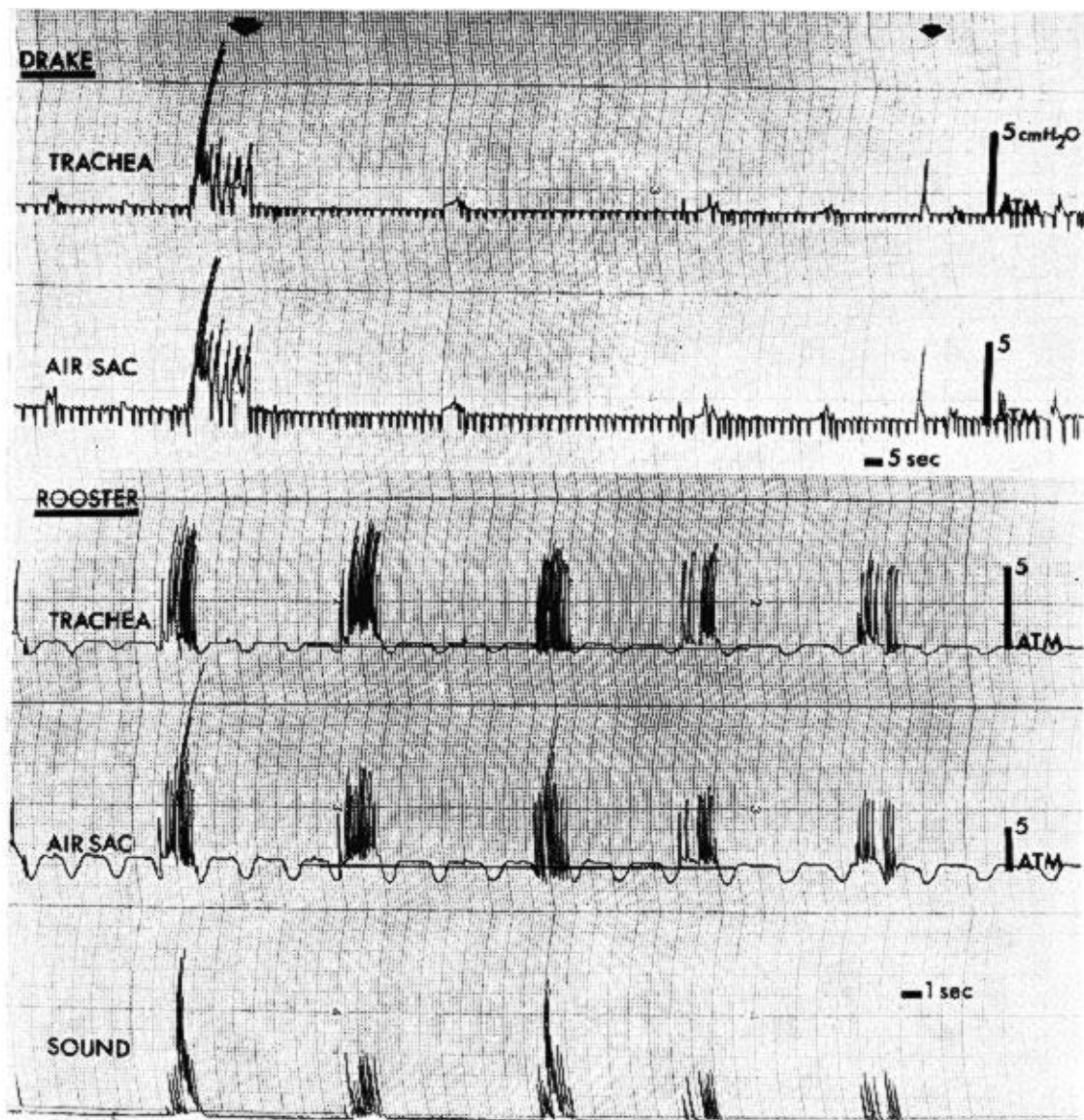

FIGURE 4. Clucks of mallard drake and rooster. Arrows indicate sound for drake as a sound trace was not obtained. Rooster shows "burst-clucking." The level of atmospheric is indicated for the three central bursts. Note that the last series is of two bursts separated by a brief, but full inhalation.

older, more "confident" appearing birds. It is given with the head held high and bill widely gaped. Squawks also may be classified as long sounds, but we obtained no clear records of these. All of the sounds investigated are rich in harmonics. Calls differ primarily in the position of the fundamental frequency and number of harmonics. We made no attempt to relate pressure events to modulation of the sounds.

#### CLUCKS

Clucks may be uttered either singly with one or more full inhalations between each call or in bursts of two or more calls in rapid succes-

sion with each burst separated by one or more full inhalations (figs. 4, 5A, 8). Either individual calls or bursts may be entrained in long series, especially in chickens, which often call continuously or with only short interruptions for several minutes.

The clucks of ducks and chickens show a characteristic set of pressure events (figs. 3, 4, 5A, 8). Each cluck is accompanied by a simultaneous, pulsatile pressure rise in air sacs and trachea. The amplitudes of these pulses are variable; in chickens they usually fall between 15 and 25 cm H<sub>2</sub>O in the air sacs, and between 8 and 16 cm H<sub>2</sub>O in the trachea. Values for air sac and tracheal pres-

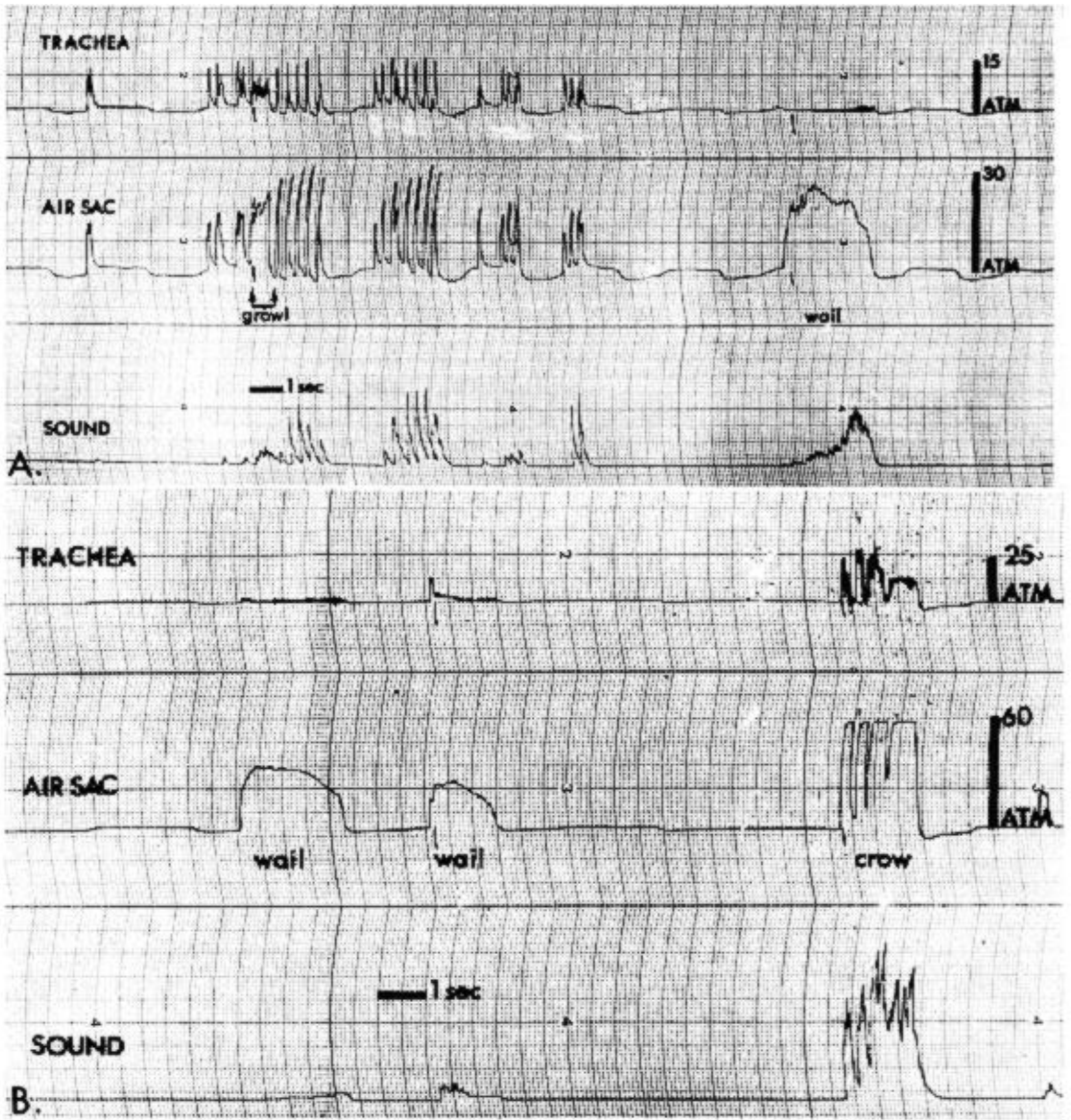

FIGURE 5. Tracheal and air sac pressures during prolonged calls. Note that sound production slightly follows the increase in air sac pressure and coincides with a reduction in tracheal pressure. Onset of sound is marked in the pressure traces for the growl and wail in A, one wail and crowing in B.

sures were highly correlated in two chickens ( $r = 0.64$ ,  $N = 299$ ;  $r = 0.63$ ,  $N = 191$ ), but not a third ( $r = -0.30$ ,  $N = 23$ ). In ducks the amplitudes fall between 5 and 10 cm H<sub>2</sub>O in the air sacs and 1.5 and 6 cm H<sub>2</sub>O in the trachea. Air sac and tracheal pressures were highly correlated ( $r = 0.50$ ;  $N = 54$ ).

Analysis of tracheal events is somewhat more complex. Whereas increased air sac pressure results from compression of the sacs and is essentially static, air in the trachea is moving, and pressures are dynamic. The tracheal cannula faces into the air flow. Thus, a portion of the pressure recorded reflects

changes in the velocity of the flow. If we assume that the bird does nothing to increase the resistance of the trachea to flow (in fact, it may attempt to decrease the resistance during a call by straightening the neck or dilating the glottis), then an increase in tracheal pressure indicates an increase in the flow rate and an increased amount of air exhausted from the bird. Unfortunately, the relationship is not linear, and we were unable to quantify the flow rate. We also attempted to obtain quantitative data by means of a pitot device (Brackenbury 1971). While the flow patterns obtained agree well with deductions

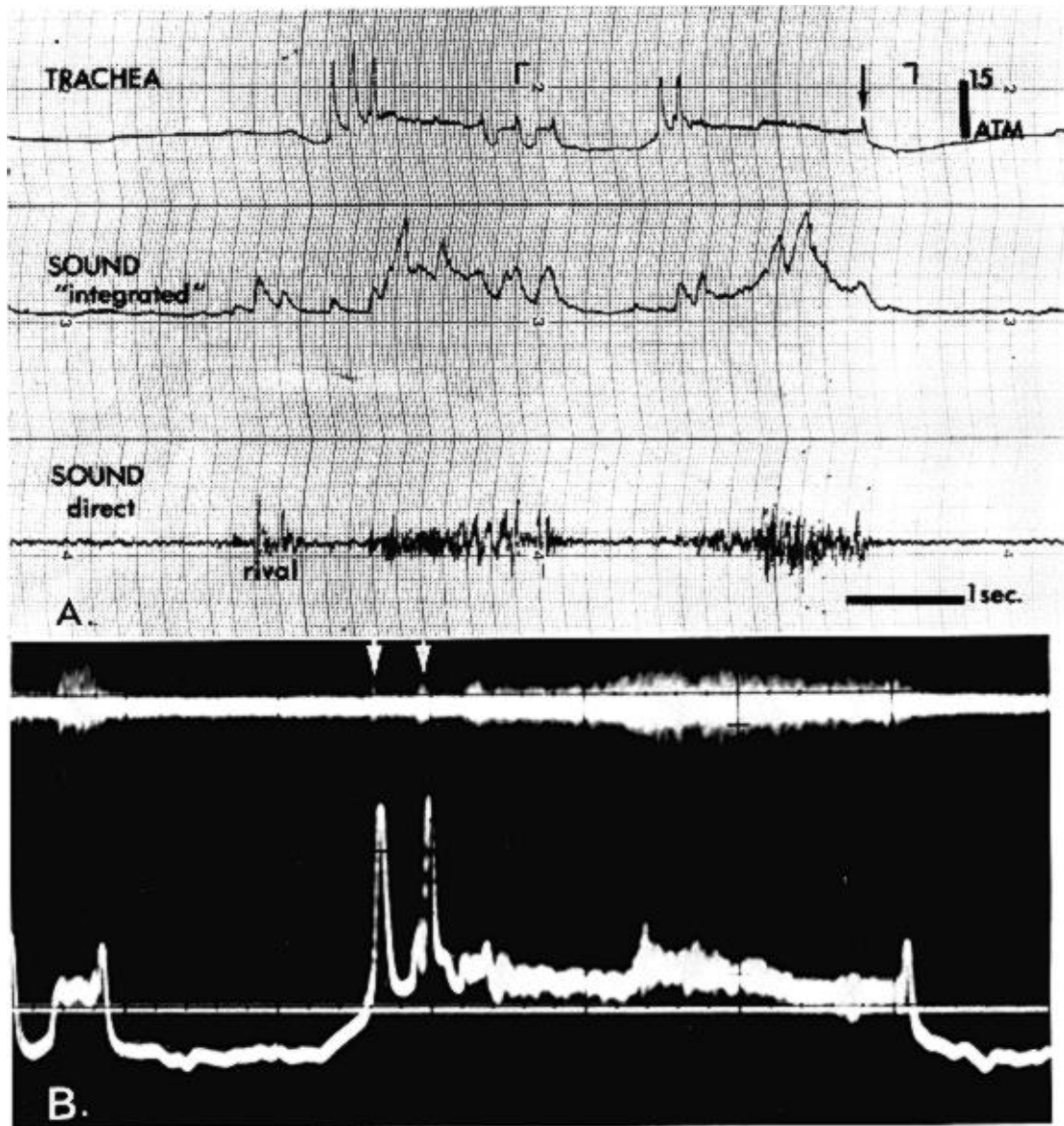

FIGURE 6. Series of clucks and growls showing a strong, terminal pulse on growls. A. Chart recording. Three clucks with last cluck blending into a growl; two short growls, prolonged inhalation, two clucks and a long growl. All growls show a terminal pulse (indicated by an arrow on last growl). Sound trace also shows clucking of rival. B. Oscilloscope trace of the portion of the chart record in brackets. Note brevity of sound during clucks (arrows).

from pressure patterns of the simple cannulae, we doubt the accuracy of the quantitative measures and prefer to test further before presenting such data.

When clucks are uttered in bursts (fig. 4), the pressure events remain pulsatile, with the pressure dropping rapidly toward atmospheric between each call. However, the dropping pressures rarely cross atmospheric in either the air sacs or the trachea and often do not even reach atmospheric. Of 100 bursts containing at least three calls, inter-pulse pressures remained at or above atmospheric

in 80, dropped below atmospheric between at least some pulses in 17 (e.g., sixth burst, fig. 4) and dropped below atmospheric consistently in only three (e.g., third burst, fig. 4). Flow through the syrinx cannot reverse unless the air sac pressures drop below atmospheric.

These results suggest two things. First, each short call is associated with a pulse of air that moves through the system encountering little resistance except that provided by the oscillating membranes. Second, flow during burst calling tends to be unidirectional, but of a pulsatile nature.

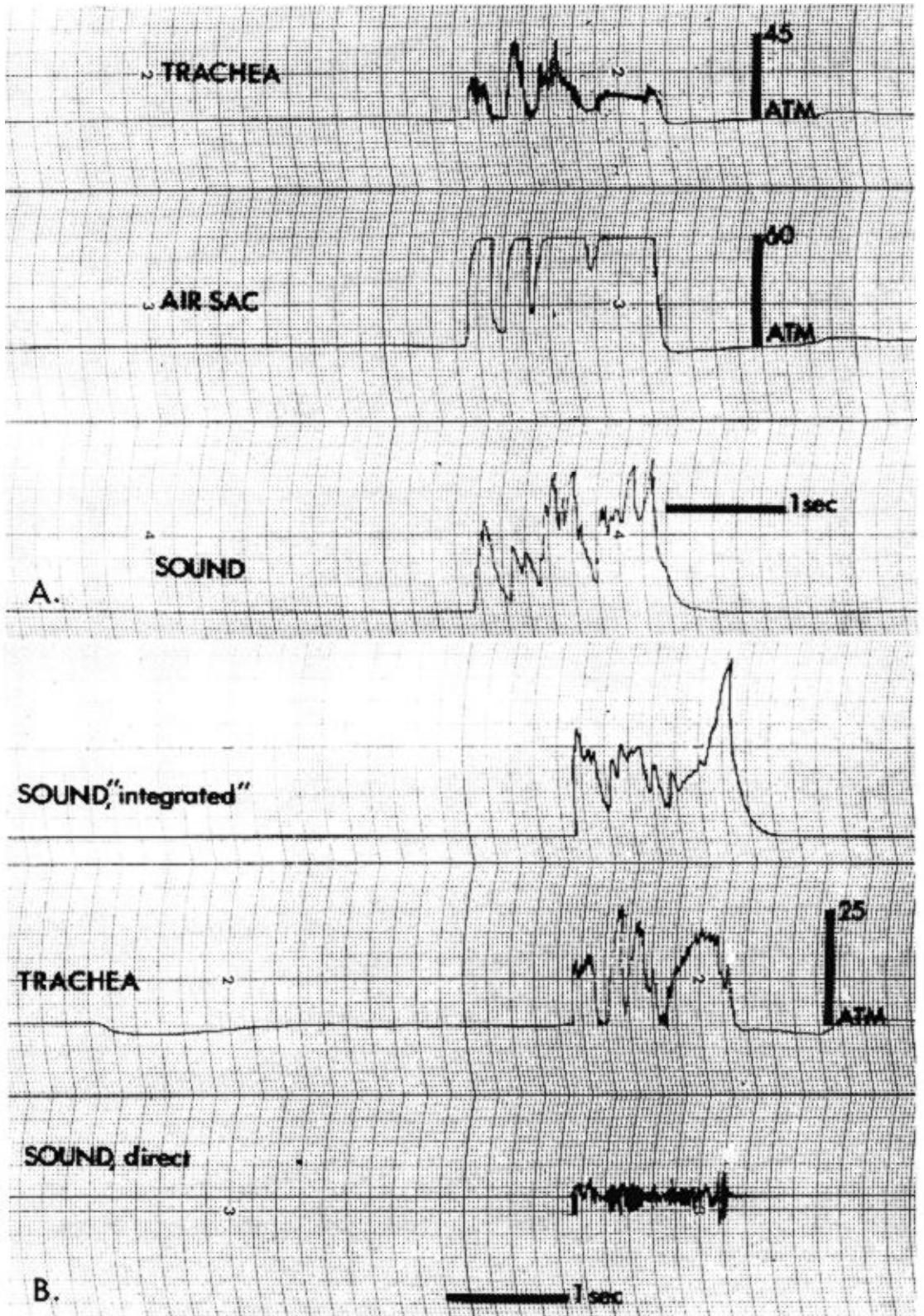

FIGURE 7. Crowing. A. Tracheal and air sac pressures vs. sound. B. Tracheal pressure vs. sound recorded in both averaging and direct modes. In these calls, the onset of sound slightly follows the increase in air sac pressure and is essentially simultaneous with the increase in tracheal pressure. The calls in A and B are recorded from different birds, each of which shows its characteristic, individual "signature" in the tracheal pressure pattern. Note that the bird in B terminates its call with a pressure pulse similar to that seen in many growls.

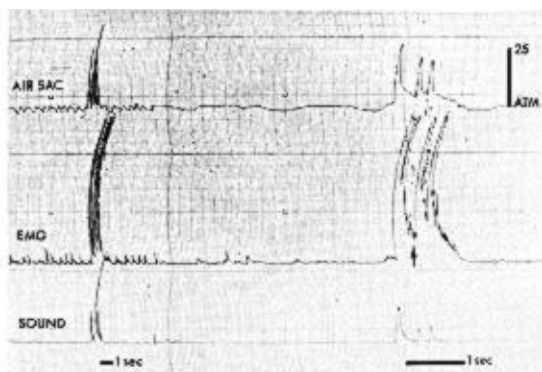

FIGURE 8. Electromyograms of abdominal constrictors (averaged from skin electrodes) during clucking; two speeds. Gain has been set to show activity during ventilatory exhalation. Hence, activity during vocalization is "off chart." Neither pressure nor muscular activity return to base level between clucks of a single burst. Activity of the constrictors actually continues. (Note "spikes" at arrow during the silent period.) Thus the delay in return to the base line cannot be attributed to the averaging circuitry. Changes in constrictor activity slightly proceed changes in pressure.

#### PROLONGED CALLS

*Air sac pressures.* Pressure patterns within the air sacs are essentially similar for all prolonged calls (figs. 5, 7A). Shortly before the onset of calling, pressure rises sharply to some relatively high value and drops just as suddenly at the termination of calling. Sound production does not appear to be related to any specific level of air sac pressure. Rather, sound begins at any pressure above atmospheric, usually during the initial sharp rise, and ceases as air sac pressure begins its terminal descent to atmospheric. Pressure may change in various ways during the call. It may remain at or near the value for the onset of sound. This "peak plateau" pattern is characteristic of air sac pressures during crowing. Alternatively, pressure may rise or decline slowly but constantly from the initial value, rise and then decline, or oscillate about some mean value. These minor fluctuations appear to be irrelevant to the quality of the sound produced, at least at the level we have analyzed. All variants may be generated by a single individual uttering apparently the same sound.

On the other hand, there are differences among the peak pressures generated during different calls (table 1). The range of values for growls extends beyond that for wails in both directions, but especially in the lower values. The mean values for growls, thus, tend to be somewhat lower than those of wails.

TABLE 1. Values (in cm H<sub>2</sub>O) for peak pressures in the air sacs during prolonged calls by two cocks that provided long, continuous records. The second bird did not wail.

	Bird 1	Bird 2
Crowing		
N	30	19
R	55.0 - 58.8	56.9 - 57.5
$\bar{x} \pm 2$ SE	57.3 $\pm$ 0.4	57.1 $\pm$ 0.07
Wail		
N	19	—
R	17.4 - 37.5	—
$\bar{x} \pm 2$ SE	27.5 $\pm$ 2.3	—
Growl		
N	74	12
R	15.0 - 47.5	7.5 - 38.8
$\bar{x} \pm 2$ SE	20.7 $\pm$ 1.4	22.2 $\pm$ 6.9

In keeping with its spectacular acoustic intensity, crowing is accompanied by very high air sac pressures, usually well above 50 cm H<sub>2</sub>O. (We have tested our transducers to confirm that the plateau associated with these high pressures is real and not an artifact due to limitations of the equipment.) Similar values were reported by Brackenbury (1972). For any individual, the peak air sac pressure achieved during crowing is remarkably constant.

Another notable aspect of crowing is that it is a chicken's only multipartite call. In its most complex form, it consists of two short, introductory notes, a moderately long transitional section with two emphases, and a prolonged, final portion. Only the first, introductory note and the final, prolonged portion are always distinct. Some individuals may eliminate the other elements or blend them into the prolonged portion. All of the records figured in this paper are taken from an individual that showed the most complex form (figs. 5B, 7A) with a clear separation of elements.

For each portion of crowing, pressure in the air sacs rises to a peak value that is maintained with virtually no fluctuation for the duration of that portion (figs. 5B, 7A). Peak value for the prolonged portion is usually slightly higher than for the short portions. Pressure drops toward, but never below, atmospheric between the portions. The drop between the transitional and final elements may be quite shallow and is absent if the elements are united. Both audiospectrograms and tapes replayed at slow speed indicate that, contrary to an auditory impression, sound production never entirely ceases during



crowling, but sound intensity changes dramatically. Any decrease in air sac pressure is accompanied by a decrease in sound intensity. In general, the gross sound intensity of any call appears to be related to the magnitude of the pressure head.

The variation in pressures during growls and wails is at least partially related to variation in acoustic intensities. Crowling is always loud, and involves a strong effort. Hence, air sac pressures driving the call are probably close to the maximum an individual can produce.

*Tracheal Pressures.* Unlike the reasonably uniform pattern of pressure events in the air sacs, pressures in the trachea during prolonged calls show several patterns varying with the type of call. One characteristic common to most tracheal patterns is the occurrence of irregular, high-frequency, low-amplitude oscillations (see especially fig. 6B). These oscillations are not always present, and their detection may depend to some extent on the placement of the cannula, but they are most frequently associated with loud calls. They probably reflect turbulence imparted to the air column by the vocalizing process. We have observed nothing similar in tracheal pressures of oscine calls, however loud.

*Growls.* During the utterance of a growl (figs. 5A, 6), tracheal pressure rises and is sustained at levels well above atmospheric (3 to 10 cm H<sub>2</sub>O). The mean level tends to fluctuate with any sudden change in air sac pressure. Tracheal pressure events during growls often follow a sequence that might be described as "pulse-call-pulse" (fig. 6). The tracheal pressure begins to rise in synchrony with air sac pressure, but drops almost immediately as sound begins. This rapid rise and fall constitutes the introductory pulse. Pressure is then maintained at the vocalizing level until sound production ceases, whereupon another rapid rise and fall produces a terminal pulse. Either or both of the pulses may be absent. The introductory pulse is always absent if the growl develops directly from a cluck. Similar pulses are sometimes recorded for other long calls (see second wail, fig. 5B, and crowling, fig. 7B).

This pattern again clearly associates vocalization with imposition of a specific resistance, not the attainment of a specific pressure. Presumably that resistance is supplied by the vibrating membranes as they move into the lumen and partially occlude it. Moreover, the variations in the pattern strongly suggest that the pressurization and resistance phases

of vocalization are independent. That is, simple pressurization of the system, even with an accompanying increase in air flow, is not sufficient to draw the membranes into the syringeal lumen. Some activity of tracheal muscles is necessary. Evidently the abdominal compressors and tracheal muscles do not share a common access to a call generator in the central nervous system, and their actions may not be completely synchronized.

*Crowling.* Crowling (figs. 5B, 7) is associated with a remarkable series of tracheal pressure events. With each short portion, the pressure rises to a peak value then subsides to near atmospheric. A similar, but more prolonged rise and fall accompanies the transitional element, but here pressure may not subside to atmospheric before the onset of the prolonged portion. During the final element, pressure may rise and hold at a moderate level, sometimes with a slight increase just before termination (figs. 5B, 7A), or gradually rise to a level as high as that of the preceding portions (fig. 7B).

Substantial variation exists both within and among individuals. Most of the variation within individuals is found in peak values, especially in the shorter portions, which may change by almost 100% from one call to the next. Obtained peak values range between 15 and 25 cm H<sub>2</sub>O for the shorter portions, 28 and 58 cm H<sub>2</sub>O for the longer. Differences among individuals are seen in both the mean peak values and total pattern. Such differences are hardly surprising in view of the fact that the calls of different roosters can be easily distinguished at considerable distances by even an untrained ear. Undoubtedly this individuality is of considerable social import.

Similarities and differences between air sac and tracheal pressures are perhaps more interesting. Gross changes in air sac pressure are reflected in the tracheal pressure. This is to be expected as tracheal pressure is dependent on both the driving pressure head and imposed resistance. Beyond the gross similarities, however, there are notable differences. These presumably reflect the action of the resistance. Whereas air sac pressures show little variation in either magnitude or pattern, or between calls within or among individuals, tracheal pressures vary in all of these aspects. Whereas peak values during crowling tend to remain constant within the air sacs, they may fluctuate in the trachea, the pattern of fluctuation being constant for an individual.

*Wail.* This call (fig. 5) effects a pattern

of tracheal pressures different from any of the preceding calls. Although events in the air sacs are similar to those of a growl, and although the sound may be very loud, tracheal pressures usually hold just above atmospheric. The records usually indicate some turbulence that is greatest as the call begins and/or ends. The mean pressure level is relatively constant showing few of the small fluctuations commonly observed in other calls, except that a few wails show a period of elevated pressure as sound begins, as if the resistance were not completely "set." This pattern implies that the call requires the imposition of a strong, constant resistance that permits the passage of only a small volume of air. Some growls show a pattern in which the mean tracheal pressure drops very close to atmospheric (fig. 6), and the tracheal pressure in some wails may be slightly above atmospheric for at least a portion (second wail, fig. 5B). Hence, there seems to be a gradient in the amount of resistance to flow that a bird can impose. Wails lie at one extreme, clucks at the other.

The occurrence of high resistance, comparable with that previously observed in oscines, was totally unexpected. Indeed it has been one of our basic tenets (Gaunt and Wells 1973) that membranes held together only by a pressure differential that, in turn, is partially dependent on flow between the membranes could not provide such a strong resistance.

The ability of a chicken's syrinx to severely impede flow derives from its rather unusual structure. By manipulating the syringes of anesthetized and dead birds, we have determined that if the drum is drawn caudad, the membranes of the constricted portion between the drum and the pessulus (fig. 1) fold inward until they press against each other cranially and against the pessulus caudally. In some specimens the trachea could be moved sufficiently caudad for the membrane on each side to fold over itself with the anterior portion surrounding the posterior portion like a cuff. Viewed in cross section, the folds form a closure that closely resembles a glottis (or thick vocal cords). This arrangement of the membranes has been described and figured by Beebe (1925:216, fig. 21). Insertion of a vacuum line into the trachea following closure elicits a loud, high-pitched sound resembling a wail. Electrical stimulation of the tracheal muscles shows that strong, bilateral contractions of either *M. sternotrachealis* or *M. tracheohyoideus* (*ypsilotrachealis* of many au-

thors) provide an appropriate caudad movement of the drum.

Application of a strong vacuum can collapse the syrinx, especially in young birds, and produce sound even if the drum is not drawn caudad. But this situation is clearly beyond the natural abilities of any bird and need not be considered further. It does, however, illustrate one of the dangers of using this (unfortunately necessary, see p. 219) technique for examining syringeal action.

#### ELECTROMYOGRAMS

The abdominal compressor musculature shows activity during any increase in internal pressures, whether ventilatory or vocal. That activity increases dramatically during the strong compressions necessary to generate the high pressures of vocalization.

The pattern of muscular activity during bursts of clucking is most revealing. As expected, each cluck of the burst is accompanied by an intense increase of electrical activity. The activity drops sharply but does not cease between clucks. Thus, some level of compression is continuous and is reflected in the continuous supra-atmospheric pressures between clucks.

This system may be analogized with an electrical circuit employing pulsating direct current. The initial voltage (driving pressure) is set at some value above zero (atmospheric). Then the voltage, hence current (air flow), is oscillated, but the polarity (direction of flow) remains constant. Voltages above some threshold are capable of driving some effect (sound production) if appropriate switches are closed (tracheal muscles have contracted).

Similarly, oscillations of the abdominal volume and air sac pressure need not be accompanied by the *reversal* of flow, but merely a change in the *rate* of flow. This is a critical point that will be developed below.

#### DISCUSSION

The classic model of the mechanics of chicken vocalization is perhaps best and most concisely stated by Gross (1964a:1006):

"Normally the [external tympaniform] membranes are held apart . . . by tension of the trachea. In this position air resistance is minimized and sound cannot be produced. Since only the tympaniform membranes attach the tympanum to the pessulus (a distance of about 1.5 mm), the syrinx can easily be shortened by a posterior movement of the tympanum. This is ordinarily accom-

plished by contracting the sterno-trachealis muscles . . . . As the syrinx is shortened, the tympaniform membranes are brought closer together . . . . This greatly increases air resistance and allows pressures to be built up in the bronchi and air sacs. Air passing rapidly between the membranes tends to draw them more closely together and causes them to vibrate, thus producing sound in a column of air."

This model was derived from considerations of anatomy together with experiments on extirpated syringes and a few measurements of air sac pressures. Our *in vivo* measurements of both air sac and tracheal pressures generally support the model, but certain points might be expanded.

Although the increased resistance of the vocalizing syrinx undoubtedly aids in the production and maintenance of high air sac pressures, those pressures are chiefly generated by compression of the abdomen. Indeed, the tracheal pressure pattern of most of the long calls indicates that high air sac pressures need not be synchronized with the imposition of the tracheal resistance. Rather the sequence appears to be: (1) Compression of the air sacs increases pressure and drives gas through the syrinx. (2) Imposition of the syringeal membranes into the air stream, either by the Bernoulli effect (not useful for the wail, in which we suppose the lumen is occluded), or posteriad movement of the drum, or both. This action increases resistance and initiates sound production. Given a constant driving pressure, tracheal flow depends upon the resistance, *i.e.*, the diameter of the syringeal lumen as determined by the mean position of the oscillating membranes. Hence, tracheal pressures reflect the interaction between the driving pressure head and the imposed resistance. If the resistance is strong, the difference between air sac and tracheal pressures will be relatively greater than during ventilatory exhalation when the resistance is absent. (3) Termination of vocalization by the removal of the oscillating resistance. If the resistance is removed before air sac pressures reach atmospheric, there may be another brief surge of pressure in the trachea. The sequence fits well with predictions from Greenewalt's (1968) general model of avian vocalization.

Our data provide no definitive evidence on the nature of the resistance mechanism. They do, however, strongly support the hypothesis that the necessary air sac pressures are generated independently from setting the syrinx into

a vocalizing configuration. Further, it seems probable that a high flow rate *per se* normally is not sufficient to induce vocalization, for we have observed high tracheal pressures in the absence of sound (fig. 3). (This analysis assumes that the glottis remains open and permits flow.) Further, increased flow and the intrusion of the membranes into the syringeal lumen are not always synchronized. Hence, some change in syringeal configuration, presumably induced by action of the tracheal muscles, is required. True, the literature abounds with accounts of sound elicited by the application of artificially induced flow through the syrinx, but the flow rates of such experiments are probably abnormally high (Gaunt *et al.* 1973). Gross (1964a) demonstrated that the driving pressure necessary to produce sound from an isolated chicken syrinx varies with the degree to which the membranes are relaxed. It is, of course, possible that a bird could set its syrinx in an appropriate configuration and then control sound production by varying the driving pressure, hence flow rate, about some critical level. Thus, a bird might have a series of behavioral options for exploiting the system. Such options might be useful in different physiological conditions or in case of injury to some portion of the system.

Our electromyographic experiments (Gaunt and Gaunt, *in press*) show that setting the syrinx is a more complex operation than simple contraction of the sternotrachealis muscles. Other muscles associated with the trachea may become active before sound production begins.

Patency of the air sac system seems to be necessary for proper functioning of the syrinx. Hérisant (1753) found that rupturing the interclavicular air sac rendered a bird mute. We have attributed the loss of voice in starlings to the creation of an alternate pathway for the escape of gas (Gaunt *et al.* 1973).

Youngren *et al.* (1974) have shown that a chicken remains silent when the interclavicular air sac is ruptured even though the openings to the rest of the respiratory system are sealed and flow through the trachea is normal. Hence, the alternate pathway hypothesis cannot apply to this species. Gross (1964a) found that he could not elicit sound from an extirpated syrinx of a chicken unless the pressure surrounding the syrinx were at least equal to that in the bronchi. These facts, taken together with our finding that pressure in the trachea is above atmospheric when chickens

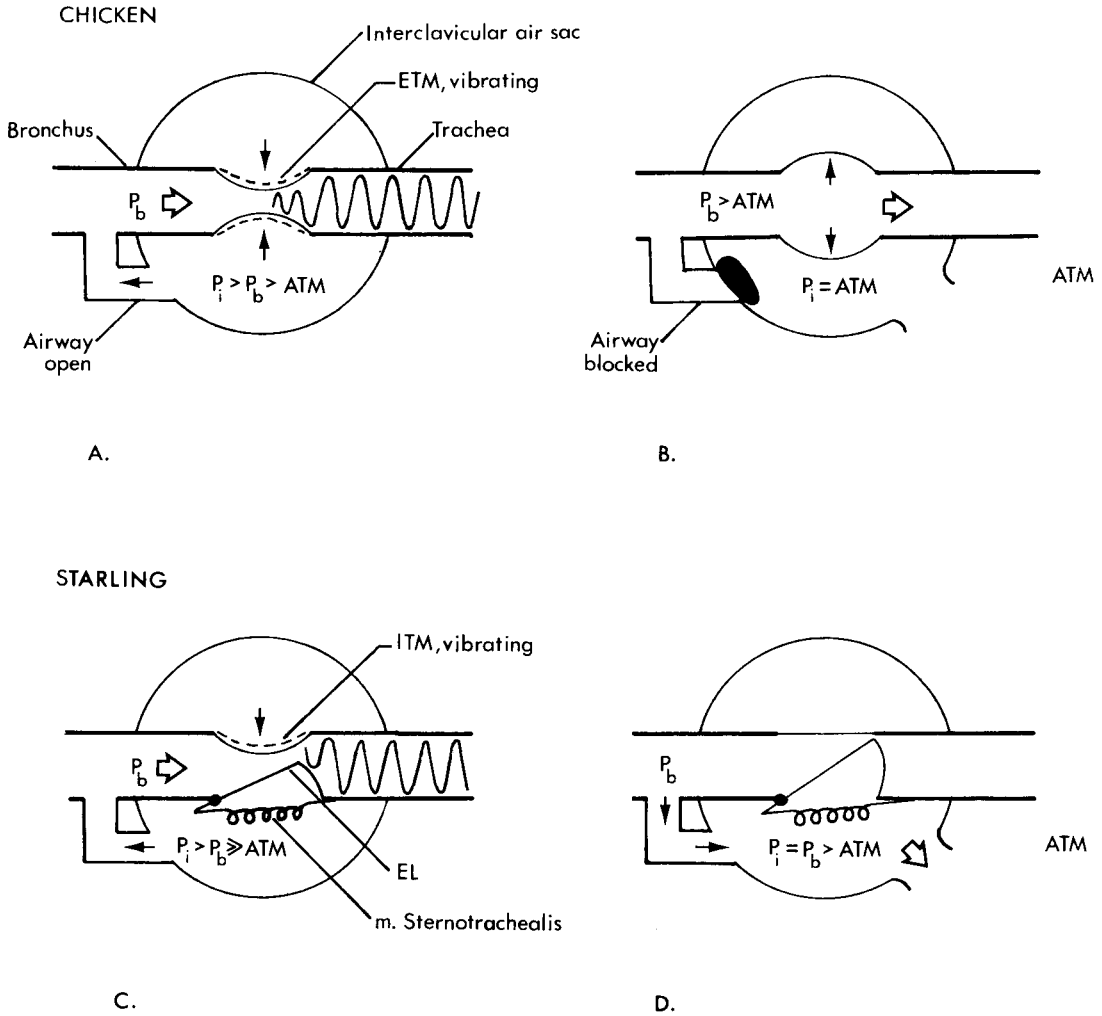

FIGURE 9. Diagrammatic representation of Hérisant experiments in chickens and starlings. In normal chicken (A) the Bernoulli effect reduces intra-syringeal pressure ( $P_b$ ) below that of the surrounding air sac ( $P_i$ ) and the external tympaniform membranes (ETM) are forced into the airstream. If the air sac is ruptured (B), pressure surrounding the syrinx is reduced to atmospheric and the membranes are forced out of the air stream. The bird remains silent even if passages to the air sac are blocked and flow continues through the syrinx. In normal oscines (C) air sac pressure is sufficient to overcome the resistance of the syringeal "valve" (EL). If the air sac is ruptured (D), flow follows the path of least resistance. Intra-syringeal pressure is not sufficient to overcome the resistance of the valve and flow through the syrinx stops. These drawings represent interpretive models that should not be considered proven. See text for discussion.

vocalize, lead to a complete hypothesis of the pressure relationships necessary for vocalization by chickens.

In order to vocalize, chickens must first relax the tympaniform membranes so that these may move into the air stream. This is accomplished by drawing the drum caudad. A medial movement of the membranes into the lumen is insured by the pressure differential across the membranes (fig. 9). A small and probably insignificant component of that differential exists constantly because of impedance in the air passages between the sacs and the trachea, but the major source of the differential is the Bernoulli effect created by the

rapid passage of gasses through the syrinx. At this point we must recall the critical fact that the pressure in the syrinx is low *relative to the pressure in the surrounding interclavicular air sac, not relative to atmospheric*. As our measurements show, the pressure in the chicken's trachea, which must be at least as high as pressure in the syrinx, is substantially *above* atmospheric. Hence, if the air sac is ruptured and pressure surrounding the syrinx is reduced to atmospheric, then pressure in the syrinx during any form of exhalation will always be greater than pressure in the air sac regardless of the rate of flow. Under these conditions the direction of the pressure differential is re-

versed and, rather than being drawn together into the air stream, the flexible membranes will be forced apart (fig. 9B). Vocalization under these conditions is clearly impossible.

We must emphasize that the above analysis applies only to those species for which the syringeal arrangement is essentially similar to that in chickens. It cannot be applied to starlings nor probably to other oscines, because these birds remain voiceless even though pressure in the interclavicular air sac is above atmospheric. Further, flow into the trachea remains negligible. Evidently the ability of the oscine syrinx to restrict flow does not depend on a trans-membranous pressure differential between the syringeal lumen and surrounding interclavicular air sac. If the resistance is complete, intra-syringeal pressure becomes essentially static, and equal to that of the rest of the internal system. In the absence of flow, the internal tympaniform membranes cannot vibrate. If the resistance is high but not complete, flow will be restricted, the pressure differential across the membranes will be small, and the ability to vocalize will be reduced. In fact, our data (see fig. 8 in Gaunt et al. 1973) show that at peak air sac pressure there is some flow into the trachea, and a starling may then utter weak squeaking sounds.

While some studies (Gottlieb and Vandenberg 1968, Lockner and Murrish 1972) show that vocalization by mallard ducks is not dependent on the patency of the air sac system, others have achieved complete silencing (R. E. Phillips, pers. comm.). These facts suggest that at the very least, the mechanisms for activating the syrinx are different in passerines and perhaps mallards from those in chickens. The internal configuration of the syrinx in passerines probably depends on the positions of specific bronchial half-rings (Chamberlain et al. 1963). The position of the rings, in turn, is controlled by the intrinsic syringeal musculature. The vocal membranes of male mallards vibrate in the plane of air flow (Lockner and Youngren 1976). In this respect these membranes resemble the mammalian condition more closely than that of other birds.

A major reason for examining pressures in the chicken was the absence of the external labium. If, as we have hypothesized, one of the functions of this structure is to reduce air flow (reflected by very low tracheal pressures during broadcast), then birds without such a structure should show high tracheal pressures (reflecting high rates of flow) during broadcast. With the exception of the spe-

cial case of the wail, the pressure patterns of all sounds we have so far examined in chickens conform to this prediction. Whereas tracheal pressures during the loud, prolonged distress calls of starlings occasionally reach ventilatory levels, but are usually close to atmospheric, tracheal pressures during most loud, prolonged calls in chickens are well above atmospheric and usually well above ventilatory levels.

Tracheal pressures during clucks show the same pulsatile pattern as air sac pressures, differing only in magnitude. Evidently the resistance of the syringeal membranes is insufficient to provide a detectable deviation from an uninterrupted flow pattern. We are currently investigating pressure events during similar short, explosive calls by oscines. Internal events appear to be similar to those in chickens and ducks, but tracheal patterns appear to be highly variable both between and within individuals. There is, however, no compelling evidence, as in the distress call, for the use of a tight valve. Of course, if a major function of that valve is to reduce air flow, its use during short calls would be of minimal advantage.

It appears then that our initial hypothesis implicating the EL as a portion of a valve is supported. Pressure events clearly seem to differ between oscines and non-passerines as represented by chickens. These differences indicate that: (1) syringeal mechanisms of the two groups are quite different, although both probably exploit similar acoustic principles, and (2) birds without an EL consume relatively more air during prolonged vocalization. Hence, we would urge considerable caution in any attempts to generalize concerning the details of the mechanics of sound production throughout the class Aves.

Given that caveat, we may look at a somewhat different problem. Calder (1970) presented data that he interpreted to indicate that birds such as canaries (*Serinus canaria*) may produce prolonged bursts of sound by indulging in very short inhalations ("mini-breaths") even between the individual notes of a trill. He suggested that such mini-breaths might occur at rates up to 25 per sec during trills. In terms of our electrical circuit analogy, Calder wished to employ an alternating current in which production of the desired effect requires *both* an appropriate voltage and polarity.

Calder's experiments utilized an impedance pneumograph, a device that measures changes in body volume by measuring the changes in impedance between sets of electrodes. The

device has two major drawbacks for this type of experimentation. First, impedance changes with various factors including the position of the bird. Hence, it is not possible to establish a common baseline to which all events can be referred. Second, internal events are not measured directly. Rather, the changes in impedance are assumed to reflect changes in volume that are accompanied by changes in air sac pressure. Yet it is possible to have an increasing volume in which internal pressures, while decreasing, remain above atmospheric and flow remains unidirectional.

We do not dispute Calder's basic statement that abdominal or thoracic volume may increase to some extent between the notes of a trill, but we believe that there are at least four possible ways to explain his specific data. These are shown by the models in figure 10. In each of these models the vocal mechanism is treated as a black box, the activity of which will not be considered. The internal respiratory system, both air sacs and lungs, is represented by the chamber to the left of that box.

In the first model the animal possesses not only the internal chamber but also an external chamber that can be closed by a valve. The two chambers are linked in such a way that their volumes can be changed reciprocally. This arrangement, which facilitates an oscillating flow through the vocal apparatus, has been demonstrated in toads (Martin and Gans 1972). A similar situation presumably occurs in whales (Evans and Maderson 1973). Although an appropriately positioned chamber does exist in some birds, e.g., grouse and bitterns, it is not a general feature of the avian vocal system. Hence, this model is probably inappropriate, at least for canaries.

The second model illustrates Calder's mini-breath hypothesis. Here all oscillations take place in the internal chamber where pressures fluctuate sufficiently above and below atmospheric to reverse flow through the vocal mechanism.

The third model shows a situation in which a constant compression is applied to the internal chambers, but flow is interrupted by an oscillating valve, either associated with or external to the vocalizing mechanism. As the valve opens, flow and sound proceed. When the valve closes, flow and sound cease, and elastic recoil provides small volume fluctuations through the system. Either the EL or the glottis is appropriately placed to serve as such a valve.

The fourth model illustrates the situation that we have discussed earlier. Here the

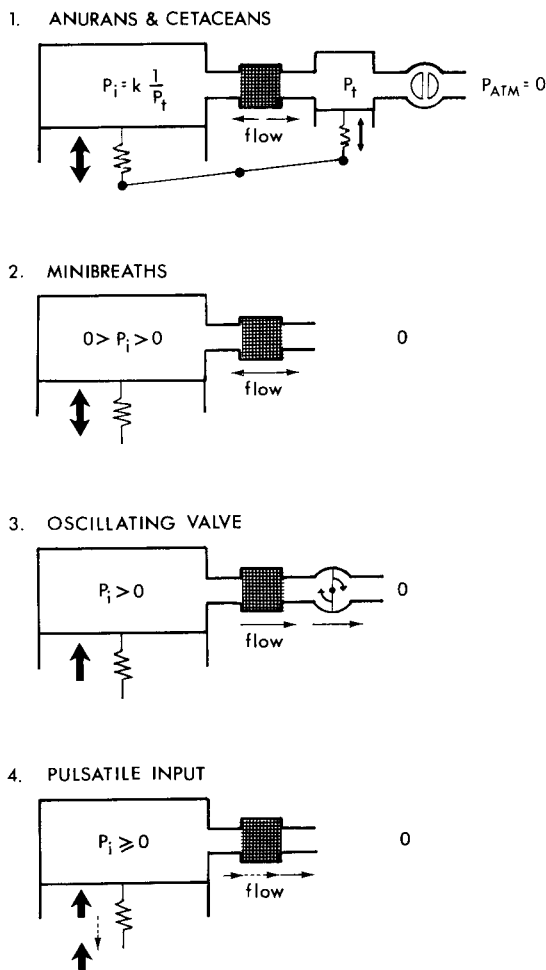

FIGURE 10. Models of regulation of flow through the syrinx (hatched box). A. Two chamber model; pressure of internal chamber varies reciprocally with that of external chamber. B. Mini-breaths; internal pressure oscillates *above* and *below* atmospheric. Flow is out if  $P_i > 0$ , in if  $P_i < 0$ . C. Oscillating valve; internal pressure is consistently high, but flow is interrupted by valve and becomes pulsatile. D. Pulsatile input; internal pressure oscillates *above* atmospheric. Flow is constant in direction but varies in rate.  $P_i$ , internal pressure;  $P_t$ , tracheal pressure. See text for discussion.

chamber is compressed until pressure is above atmospheric and flow is in an outward direction. The chamber is then subjected to a series of strong pulsatile contractions with gravity, internal pressure, and the elasticity of the system providing for an expansion of the chamber between pulses. Flow is unidirectional but pulsatile.

We have previously shown (Gaunt et al. 1973) that the air sac pressures of a starling uttering a staccato call (slow trill) were maintained above atmospheric throughout the call but showed rapid oscillations. These data

seemed to eliminate the possibility of mini-breaths, but we were unable at that time to choose between the oscillating valve and pulsatile flow models.

Both pressure and electromyographic data strongly support the pulsatile flow model for rapidly clucking chickens. Such clucking may not be mechanically equivalent to trilling of oscines and, as we cautioned, it is not wise to generalize too broadly between non-passerines and oscines. The fact that chickens do not have an EL makes it unlikely that they could use the oscillating valve system. Use of the glottis for such a valve should produce obvious movements of the throat, and we have not observed such. Note again figure 4. That figure shows six bursts of clucks. Three are essentially identical in that neither tracheal nor air sac pressures drop below atmospheric during the entire burst. However, in the central burst both tracheal and air sac pressures drop below atmospheric between each cluck. Whether or not the pressure differential generated would be sufficient to reverse flow to any substantial degree is not certain, but the record of the central burst could support the mini-breath model. Evidently a chicken has available a considerable range of choices for activation of the system, and may alternate among those choices *ad libitum*. Again we have an example of the kind of variation of which the system is capable.

Except for crowing, the pattern of events in the air sacs reveals little about the identity of the sound produced. This difference between the tracheal and internal records is entirely reasonable. The mechanical role (setting aside any possible modulatory role) in vocalization of the air sacs and abdominal musculature is to provide an energy source in the form of pressurized gas to drive the system. The events are simple and conform to invariable physical laws. Only the magnitude and duration of the pressurization are subject to significant variation. Because this power system is essentially similar for all birds, we believe that it is possible to compare its actions in chickens and canaries. While we cannot eliminate the oscillatory valve model for oscines, it seems reasonable to suppose that its occurrence would constitute a case of specialization.

Finally, it is clear that the avian vocal system is both plastic and redundant. This affords considerable potential for variation both among species and at the whim of the individual. It is precisely this potential that at once renders the system so fascinating and so fruitful a subject for investigations of many kinds.

## SUMMARY

The pattern of air sac pressure events during vocalization is simple. Pressure rises shortly before the onset of calling and drops as vocalization ceases. The peak value attained is related to the loudness of the call. Internal pressure events in chickens and ducks are similar to those observed in oscines. However, tracheal pressures during prolonged, loud calls of starlings, remain near atmospheric, but those of chickens show an interaction between the resistance to flow effected by activity of the vibrating membranes and internal pressures. Tracheal pressure in chickens usually rests substantially above atmospheric, indicating a substantial flow of air into the trachea. This observation supports the hypothesis that the external labium, a structure found in oscines but not chickens, may function as a valve that serves to increase the loudness of a call while reducing the volume of gas exhausted.

A single exception, a loud, wailing call, uttered by some roosters, shows a pattern of high air sac pressures with tracheal pressures near atmospheric. This situation may be explained by the structure of the chicken's syrinx. If the drum is drawn caudad as far as possible, the vibrating membranes fold inward and meet between the drum and the pessulus, thereby occluding the lumen of the syrinx. Electrical stimulation of tracheal muscles in anesthetized chickens shows this explanation to be mechanically possible.

Experiments performed elsewhere show that rupture of the interclavicular air sac renders both chickens and starlings voiceless. However, the mechanism appears to differ between the two species. In the oscine, air flow is re-routed along a pathway of low resistance, bypassing the syrinx. Chickens remain silent even if flow through the syrinx is restored. Here the loss of vocal ability can be attributed to the reversal of the pressure differential between the interclavicular air sac and syringeal lumen with the resulting movement of the vocal membranes out of rather than into the airstream.

Activity of the muscles that constrict the abdomen, in combination with pressure events, shows that staccato calls by chickens are produced by an airflow that is constant in direction but variable in rate. This is in contrast to the mini-breath hypothesis of Calder, which supposes a reversal of flow. Mini-breaths, however, may be available as an alternative technique.

## ACKNOWLEDGMENTS

We thank Cindy Bucher and Henry M. Young for help in caring for our animals and during surgery. Orlan M. Youngren kindly provided a preprint of a paper in press. Jerry Downhower, Lewis Greenwald, and Richard E. Phillips commented on our manuscript. This work was supported by a Grant, GB-40069, from the National Science Foundation.

## LITERATURE CITED

- BEEBE, [C.] W. 1975. The variegated tinamou, *Crypturus variegatus variegatus* (Gmelin). *Zoologica* 6:195-227.
- BRACKENBURY, J. H. 1971. Airflow dynamics in the avian lung as determined by direct and indirect methods. *Respir. Physiol.* 13:319-329.
- BRACKENBURY, J. H. 1972. Lung-air-sac anatomy and respiratory pressures in the bird. *J. Exp. Biol.* 57:543-550.
- CALDER, W. A. 1970. Respiration during song in the canary (*Serinius canaria*). *Comp. Biochem. Physiol.* 32:251-258.
- CHAMBERLAIN, D. R., W. B. GROSS, G. W. CORNWELL, AND H. S. MOSBY. 1968. Syringeal anatomy in the common crow. *Auk* 85:244-252.
- EVANS, W. E., AND P. F. A. MADERSON. 1973. Mechanisms of sound production in delphinid cetaceans: a review and anatomical considerations. *Amer. Zool.* 13:1205-1213.
- GAUNT, A. S., AND S. L. L. GAUNT. Mechanics of the syrinx in *Gallus gallus*. II. Electromyographic studies of *ad libitum* vocalizations. *J. Morphol.*, in press.
- GAUNT, A. S., R. C. STEIN, AND S. L. L. GAUNT. 1973. Pressure and air flow during distress calls of the starling, *Sturnus vulgaris* (Aves; Passeriformes). *J. Exp. Zool.* 183:241-262.
- GAUNT, A. S., AND M. K. WELLS. 1973. Models of syringeal mechanisms. *Amer. Zool.* 13:1227-1247.
- GOTTLIEB, G., AND J. G. VANDENBERGH. 1968. Ontogeny of vocalization in duck and chick embryos. *J. Exp. Zool.* 168:307-326.
- GREENEWALT, C. H. 1968. Bird song: acoustics and physiology. Smithsonian Institution Press, Washington, D.C.
- GROSS, W. B. 1964a. Voice production by the chicken. *Poultry Sci.* 43:1005-1008.
- GROSS, W. B. 1964b. Devoicing the chicken. *Poultry Sci.* 43:1143-1144.
- HÉRISSANT, M. 1753. Recherches sur les organes de voix des quadrupèdes et de celle des oiseaux. *Acad. Roy. Sci. Mus.*, p. 279-295.
- KADONO, H., T. OKADA, AND K. ONO. 1963. Electromyographic studies on the respiratory muscles of the chicken. *Poultry Sci.* 42:121-130.
- LOCKNER, F. R., AND D. E. MURRISH. 1972. Effect of interclavicular air sac pressures on call production in mallard ducks. *Amer. Zool.* 12:664.
- LOCKNER, F. R., AND O. M. YOUNGREN. 1976. Functional syringeal anatomy of the mallard. I. *In situ* electromyograms during ESB elicited calling. *Auk* 93:324-342.
- MARTIN, W. F., AND C. GANS. 1972. Muscular control of the vocal tract during release signaling in the toad *Bufo valliceps*. *J. Morphol.* 137:1-28.
- MYERS, J. A. 1917. Studies on the syrinx of *Gallus domesticus*. *J. Morphol.* 29:165-214.
- STEIN, R. C. 1968. Modulation in bird sounds. *Auk* 85:229-243.
- TYMMS, A. O. V. 1913. The syrinx of the common fowl, its structure and development. *Proc. Roy. Soc. Vict.* 25:286-304.
- WARNER, R. W. 1969. The anatomy of the avian syrinx. Ph.D. diss., Univ. London.
- YOUNGREN, O. M., F. W. PEEK, AND R. G. PHILLIPS. 1974. Repetitive vocalizations evoked by local electrical stimulation of avian brains. III. Evoked activity in the tracheal muscles of the chicken (*Gallus gallus*). *Brain, Behav. Evol.* 9:393-421.

Department of Zoology, The Ohio State University, 1735 Neil Avenue, Columbus, Ohio 43210. Address of second author: Department of Biology, Capital University, Columbus, Ohio 43209. Address of third author: Department of Zoology, Indiana University, Bloomington, Indiana 47401. Accepted for publication 30 August 1975.